

## **Marine Ranching**

*Proceedings of the Eighteenth  
U.S.-Japan Meeting on Aquaculture  
Port Ludlow, Washington  
18-19 September 1989*

Ralph S. Svrjcek (editor)

---

## **NOAA Technical Report NMFS**

The major responsibilities of the National Marine Fisheries Service (NMFS) are to monitor and assess the abundance and geographic distribution of fishery resources, to understand and predict fluctuations in the quantity and distribution of these resources, and to establish levels for their optimum use. NMFS is also charged with the development and implementation of policies for managing national fishing grounds, with the development and enforcement of domestic fisheries regulations, with the surveillance of foreign fishing off U.S. coastal waters, and with the development and enforcement of international fishery agreements and policies. NMFS also assists the fishing industry through marketing service and economic analysis programs and through mortgage insurance and vessel construction subsidies. It collects, analyzes, and publishes statistics on various phases of the industry.

The NOAA Technical Report NMFS series was established in 1983 to replace two subcategories of the Technical Report series: "Special Scientific Report—Fisheries" and "Circular." The series contains the following types of reports: scientific investigations that document long-term

continuing programs of NMFS; intensive scientific reports on studies of restricted scope; papers on applied fishery problems; technical reports of general interest intended to aid conservation and management; reports that review, in considerable detail and at a high technical level, certain broad areas of research; and technical papers originating in economics studies and in management investigations. Since this is a formal series, all submitted papers, except those of the U.S.-Japan series on aquaculture, receive peer review and all papers, once accepted, receive professional editing before publication.

Copies of NOAA Technical Reports NMFS are available free in limited numbers to government agencies, both federal and state. They are also available in exchange for other scientific and technical publications in the marine sciences. Individual copies may be obtained for the U.S. Department of Commerce, National Technical Information Service, 5285 Port Royal Road, Springfield, VA 22161. Although the contents of these reports have not been copyrighted and may be reprinted entirely, reference to source is appreciated.

### **Recently Published NOAA Technical Reports NMFS**

90. **Elasmobranchs as living resources: advances in the biology, ecology, systematics, and the status of the fisheries**, edited by Harold L. Pratt Jr., Samuel H. Gruber, and Toru Taniuchi. July 1990, 518 p.
91. **Marine flora and fauna of the northeastern United States—Echinodermata: Crinoidea**, by Charles G. Messing and John H. Dearborn. August 1990, 30 p.
92. **Genetics in aquaculture: proceedings of the sixteenth U.S.-Japan meeting on aquaculture; Charleston, South Carolina, 20-21 October, 1987**, edited by Ralph S. Svrjcek. November 1990, 81 p.
93. **Distribution and abundance of juvenile salmonids off Oregon and Washington, 1981-1985**, by William G. Pearcy and Joseph P. Fisher. November 1990, 83 p.
94. **An economics guide to allocation of fish stocks between commercial and recreational fisheries**, by Steven F. Edwards. November 1990, 29 p.
95. **Larval fish recruitment and research in the Americas: proceedings of the thirteenth annual larval fish conference; Merida, Mexico, 21-26 May 1989**, edited by Robert D. Hoyt. January 1991, 147 p.
96. **Marine flora and fauna of the Eastern United States—Copepoda, Cyclopoida: Archinotodelphyidae, Notodelphyidae, and Ascidicolidae**, by Patricia L. Dudley and Paul L. Illg. January 1991, 40 p.
97. **Catalog of osteological collections of aquatic mammals from Mexico**, by Omar Vidal. January 1991, 36 p.
98. **Marine mammal strandings in the United States; proceedings of the second marine mammal stranding workshop; Miami, Florida, 3-5 December, 1987**, edited by John E. Reynolds III and Daniel K. Odell. January 1991, 157 p.
99. **Marine flora and fauna of the Northeastern United States: Erect Bryozoa**, by John S. Ryland and Peter J. Hayward. February 1991, 48 p.
100. **Marine flora and fauna of the Eastern United States: Dicyemida**, by Robert B. Short. February 1991, 16 p.
101. **Larvae of nearshore fishes in oceanic waters near Oahu, Hawaii**, by Thomas A. Clarke. March 1991, 19 p.

NOAA Technical Report NMFS 106

## **Marine Ranching**

*Proceedings of the Eighteenth  
U.S.-Japan Meeting on Aquaculture  
Port Ludlow, Washington  
18-19 September 1989*

Ralph S. Svrjcek  
Publications Unit  
Northwest and Alaska Fisheries Science Centers

*Panel Chairmen:*  
Conrad Mahnken, United States  
Hisashi Kan-no, Japan

*Under the U.S.-Japan Cooperative Program  
in Natural Resources (UJNR)*

February 1992



U.S. DEPARTMENT OF COMMERCE  
Robert Mosbacher, Secretary  
National Oceanic and Atmospheric Administration  
John A. Knauss, Under Secretary for Oceans and Atmosphere  
National Marine Fisheries Service  
William W. Fox Jr., Assistant Administrator for Fisheries

## ***Contents*** (continued)

S. UMEZAWA	Experimentation to improve recruitment of blood ark shell, <i>Scapharca broughtonii</i> , in the Seto Inland Sea	<b>105</b>
H. NAKAHARA	The Marine Ranching System: the integration of biology and engineering technology	<b>115</b>
K. TAYA A. HASEGAWA Y. MASUI	Economic problems of the Marine Ranching System	<b>129</b>

# Reproductive Endocrinology of the Shrimp *Sicyonia ingentis*: Steroid, Peptide, and Terpenoid Hormones

ERNEST S. CHANG, WILLIAM A. HERTZ, AND GLENN D. PRESTWICH\*

*Bodega Marine Laboratory,  
University of California,  
P.O. Box 247, Bodega Bay, CA 94923*

## ABSTRACT

Female reproduction in penaeid shrimp is carefully regulated by several different endocrine factors. Their precise modes of action have not yet been fully elucidated. Three endocrine factors, each representing a different chemical class of hormones, have been investigated in the penaeid shrimp *Sicyonia ingentis* in our laboratory: ecdysteroids, vitellogenesis-inhibiting hormone (VIH), and methyl farnesoate (MF). Ecdysteroids (the steroid molting hormones of arthropods; predominantly 20-hydroxyecdysone), are initially present in low levels (<10 ng/mg) in shrimp embryos. As development of the embryos nears time of hatch, the ecdysteroid levels increase to approximately 150 ng/mg, indicating that they may be of embryonic origin and involved in embryonic development. An assay was developed for shrimp VIH, which presumably is a protein. Delay of onset of the next reproductive cycle was observed following injection of sinus gland extracts into shrimp that had previously had their eyestalks removed. A photoaffinity analog was synthesized for the putative shrimp reproductive hormone MF—a terpenoid. This analog, farnesyl diazomethyl ketone (FDK), was used to demonstrate the presence of specific binding proteins for MF in shrimp hemolymph.

## Introduction

The control of female reproduction in penaeid (members of the superfamily Penaeoidea) shrimp is highly complex. It appears that a number of environmental signals can influence different hormonal factors which in turn regulate various aspects of the reproductive process. The understanding of this regulation is an area of intense research (*see* reviews by Adiyodi 1985; Charniaux-Cotton and Payen 1988). In addition to the basic biological studies in comparative endocrinology, there is great interest in the applied aspects of this research.

Penaeid shrimp comprise one of the most economically important marine products both domestically and worldwide (Rosenberry 1990). While natural fisheries for shrimp have declined, there has been a concomitant surge in aquatic culture of penaeids. One of the major problems preventing optimization of the commercial culture of shrimp is control of female reproduction.

We examined three areas of shrimp reproduction. First is the role of the arthropod molting hormones, ecdysteroids, in ovarian and embryonic development. Although there have been a number of studies on the role of ecdysteroids in crustacean molting (Chang 1989), relatively little is known about the action of these steroid molting hormones on ovarian and embryonic development.

Second, we investigated the activity of the vitellogenesis-inhibiting hormone (VIH). The initial observations that provided a basis for the existence of the VIH were made by Panouse (1943, 1944). He observed that, depending upon the molt stage, removal of the eyestalks from the shrimp *Palaemon serratus* resulted in accelerated ovarian development and spawning. Similar observations have been made in a number of natantians (*see* Chang 1992).

\* Permanent address: Department of Chemistry, State University of New York, Stony Brook, NY 11794-3400.

buffer, mixed, and boiled 4 minutes. Samples (45  $\mu$ L) were loaded onto a  $0.75 \times 150 \times 150$  mm denaturing polyacrylamide gel (SDS-PAGE, 12% acrylamide), stacked at 13 mA per gel, and separated at  $10^\circ\text{C}$  at 18 mA per gel using a Tris-glycine pH 8.3 running buffer. Gels were stained (4 h) with Coomassie Blue R250 and then destained (95% ethanol:H<sub>2</sub>O:acetic acid, 50:40:10).

The destained gel was rinsed for 5 minutes with glacial acetic acid and then impregnated with diphenyloxazole (15% PPO in glacial acetic acid) for 25 minutes. The acetic acid was poured off and the gel was treated with 50% PEG 2000 at  $50\text{--}75^\circ\text{C}$  for 30 to 40 minutes. The miniaturized gels (Mohamed et al. 1989) were dried and exposed to pre-flashed Kodak XAR-5 x-ray film for 5–15 days at  $-75^\circ\text{C}$ .

## Results and Discussion

### Embryonic Ecdysteroids

The concentration profile of ecdysteroids in the hemolymph of *Sicyonia ingentis* is similar to those of most other crustaceans that have been examined (Fig. 2; see Chang 1989). There are low levels during postmolt and intermolt with a dramatic increase just prior to ecdysis (premolt). This peak falls back to basal levels just prior to ecdysis. Approximately similar values were obtained in the shrimp *Palaemon serratus* (Baldaia et al. 1984; Van Wormhoudt et al. 1986).

Since ecdysteroids play such an important role in larval, juvenile, and adult molting (Chang 1989), we assayed extracts of developing embryos to determine if these steroid hormones were also involved in embryonic development. Figure 3 shows the total RIA activity of extracts of embryos at various times after spawning (fertilization). Negligible levels of ecdysteroids were present in the embryos at spawning, but the concentrations increased significantly as embryonic development proceeded. These data im-

ply that there is relatively little maternal investment of ecdysteroids in the eggs and that the increasing levels of hormone observed in the extracts is likely due to endogenous synthesis.

These data are in apparent contrast to observations that our laboratory has made in the crab *Cancer anthonyi* (Okazaki and Chang 1991). These crab embryos have relatively high levels of ecdysteroids at the time of spawn (ca. 9 ng/mg wet weight) that decrease during embryonic development. This implies an embryonic utilization of the hormones during development. These differences may be due to either the dramatically different rates of development (*S. ingentis* hatches after ca. 30 hours, *C. anthonyi* after ca. 35 days) or to differences in the chemical forms of the molting hormones. For example, conjugated metabolites of ecdysteroids have a much lower affinity for the ecdysteroid antiserum and hence, if present, would give the overall appearance of less total ecdysteroid RIA activity. However, we favor the former explanation (differential rates of development).

Recently, data were presented that implicate a role for ecdysteroids in the mediation of embryogenesis in the shrimp *Palaemon serratus* (Spindler et al. 1987). In that species, although much lower concentrations were measured (peaks of about 80 ng/g), a similar hormone pattern was observed of low levels of ecdysteroids at egg extrusion followed by increasing levels near hatch.

### Vitellogenesis-Inhibiting Hormone

*S. ingentis* is a useful species for the assay of VIH because it undergoes several cycles of reproduction without intervening molt cycles in the summer months. Following a spawn, shrimp were injected with extracts of sinus glands obtained from winter (nonreproductive) female shrimp. A significant inhibition ( $P < 0.01$ ) of ovarian development and spawning resulted. This effect was not observed in

**Table 1**  
Effect of shrimp sinus gland extracts on spawning duration.

Extract	Spawning Duration (days $\pm$ S.D.)	N
nonsinus gland neural tissue	16.31 $\pm$ 1.31	16
sinus glands	19.93 $\pm$ 2.08 <sup>a</sup>	15

<sup>a</sup>  $P < 0.01$  (Student's *t*-test).

control shrimp that were injected with nonsinus gland neural tissue (Table 1) or summer shrimp that were injected with sinus gland extracts obtained from summer donor females (Chang and Hertz, unpubl. data).

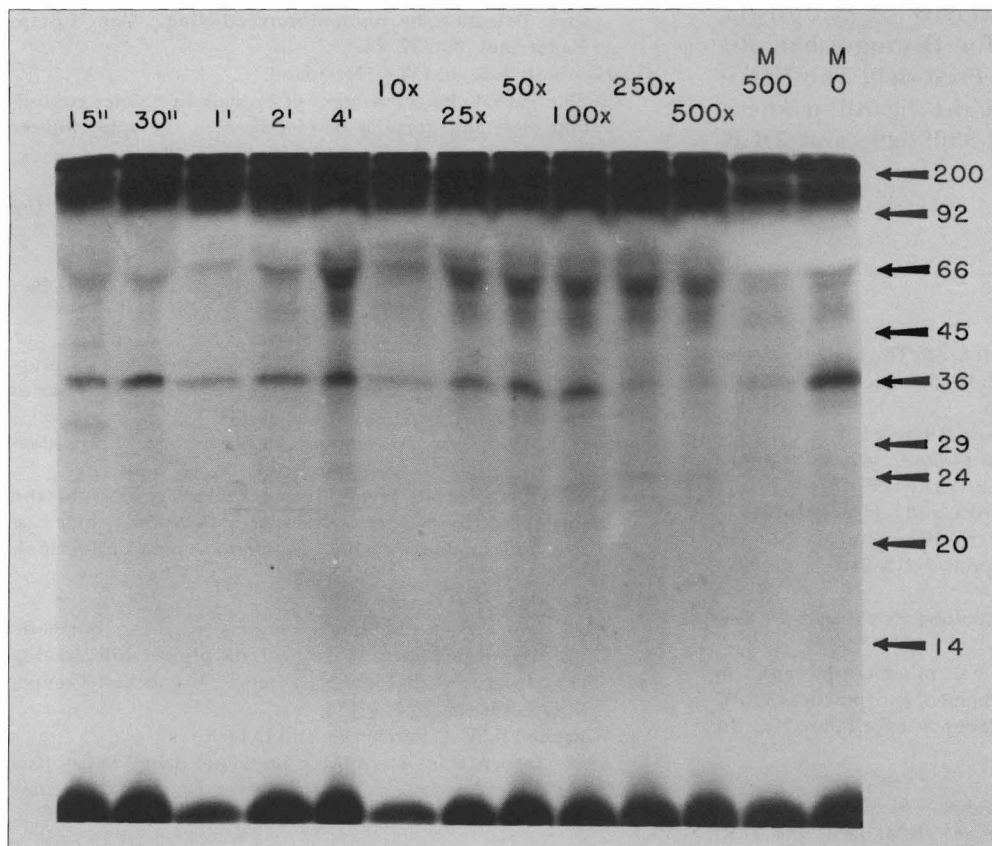
We have observed differences in the peptide profiles from sinus glands of winter (quiescent) and summer (active) shrimp following separation using high-performance liquid chromatography (Chang and Hertz, unpubl. data). We have purified these shrimp sinus gland peptides and are currently assaying them for VIH activity.

There are reports that provide some chemical information on VIH. Most of these previous experiments utilized a heterologous assay system. Bomirski et al. (1981) extracted a factor with a molecular weight of approximately 2000 from eyestalks of the crab *Cancer magister*. Their assay consisted of measuring ovarian growth in the shrimp *Crangon crangon*. A 5000 dalton factor was extracted from eyestalks of the spiny lobster *Panulirus argus*. It was assayed by measuring ovarian growth in the fiddler crab *Uca pugilator* (Quackenbush and Herrnkind 1983). A 7500 dalton peptide was isolated from sinus glands of the American lobster *Homarus americanus* and assayed in vivo in the shrimp *Palaemonetes varians* (Soyez et al. 1987). The assay consisted of measuring

oocyte diameters. Antisera were also raised against this lobster VIH which cross-reacted with sinus gland extracts from a number of different decapods (Meusy et al. 1987). A 3300 dalton factor was characterized from eyestalks of *Penaeus setiferus* as assayed in vitro using fiddler crab ovaries. This assay utilized precipitation of radiolabeled leucine by antibodies that had been generated against fiddler crab vitellogenin (Quackenbush and Keeley 1988).

### Farnesyl Diazomethyl Ketone

Using the radiolabeled photoaffinity analog of methyl farnesoate, [<sup>3</sup>H]-FDK, we examined a number of different tissues from several different species for specific hormone binding. We examined both the cytosol and membrane fractions of these tissues. Although we were unable to demonstrate cellular binding proteins for [<sup>3</sup>H]-FDK from any tissue, we consistently observed specific binding in the hemolymph. Figure 4 shows the effects of increasing amounts of unlabeled MF in the presence of a constant amount of [<sup>3</sup>H]-FDK. The radiolabeled analog forms a covalent bond with a binding protein of ca. 36,000 daltons and is effectively competed with a 250-fold excess of the unlabeled hormone. In addition,



**Figure 4**

Comparison of photolysis times (15 s, 30 s, 1 min, 2 min, and 4 min), and the quantity (fold excess) of unlabeled methyl farnesoate (MF) used to displace the labeling of female shrimp hemolymph with [<sup>3</sup>H]-farnesyl diazomethyl ketone (photolysis time was 4 min). The band at ca. 36,000 daltons appears to be specifically labeled. The lanes marked M500 and M0 represent hemolymph from male shrimp labeled with [<sup>3</sup>H]-FDK with and without a 500-fold excess of unlabeled MF, respectively. Molecular weight markers ( $\times 10^{-3}$ ) are given on the right of the autoradiograph. No labeling is observed at zero photolysis time.

the effects of increasing the length of time of U.V. irradiation is demonstrated. A high degree of attachment of [<sup>3</sup>H]-FDK to the hemolymph binding protein is observed after only 15 sec (Fig. 4). The 36,000 dalton protein appears to be present in both female and male shrimp (Fig. 4).

We have also recently utilized [<sup>3</sup>H]-FDK to characterize an analogous binding protein for MF in the hemolymph of adult female American lobsters (Prestwich et al. 1990). The lobster MF binding protein has an approximate molecular weight of 42,000.

Although a definitive hormonal role for MF has not yet been established, these data suggest that MF has a specific binding protein that may prevent its rapid degradation and may facilitate its cellular action. The role of the crustacean MF binding protein may be analogous to the insect juvenile hormone binding protein.

## Acknowledgments

We thank M. J. Bruce for technical assistance. Financial support was provided by NOAA, National Sea Grant College Program, Department of Commerce, under grant number NA85AA-D-SG140, project number R/A-68, through the California Sea Grant College Program (to E.S.C.). We also acknowledge Prof. J. Clegg and the University of California, Bodega Marine Laboratory for Distinguished Research Fellow support to G.D. Prestwich. The NSF is acknowledged for support of the ligand synthesis (Grants CHE-8809588, DCB-8509629, and DCB-8812322 to G.D.P.).

## Citations

- Adiyodi, R.G.  
1985. Reproduction and its control. *In* The biology of crustacea, vol. 9 (D.E. Bliss and L.H. Mantel, eds.), p. 147-215. Acad. Press, Inc., Orlando.
- Baldaia, L., P. Porcheron, J. Coimbra, and P. Cassier.  
1984. Ecdysteroids in the shrimp *Palaemon serratus*: relations with molt cycle. *Gen. Comp. Endocrinol.* 55:437-443.
- Bomirski, A., M. Arendarczyk, E. Kawinska, and L.H. Kleirholz.  
1981. Partial characterization of crustacean gonad-inhibiting hormone. *Int. J. Invertebr. Reprod.* 3:213-219.
- Chang, E.S.  
1989. Endocrine regulation of molting in Crustacea. *Rev. Aquatic Sci.* 1:131-157.  
1992. Endocrinology of shrimp and other crustaceans. *In* Culture of marine shrimp: principles and practices (A.W. Fast and L.J. Lester, eds.). Elsevier Science Publ., NY. *In press.*
- Chang, E.S., and J.D. O'Connor.  
1979. Arthropod molting hormones. *In* Methods of hormone radioimmunoassay, 2nd ed. (B.M. Jaffe and H.R. Behrman eds.), p. 797-814. Acad. Press, Inc., NY.
- Charniaux-Cotton, H., and G. Payen.  
1988. Crustacean reproduction. *In* Endocrinology of Selected Invertebrate Types (H. Laufer and R.G.H. Downer eds.), p. 279-303. Alan R. Liss, Inc., NY.
- Goodman, W.G., and E.S. Chang.  
1985. Juvenile hormone cellular and hemolymph binding proteins. *In* Comprehensive insect physiology, biochemistry and pharmacology, vol. 7 (G.A. Kerkut and L.I. Gilbert, eds.), p. 491-510. Pergamon Press, Ltd., Oxford.
- Laufer, H., D. Borst, F.C. Baker, C. Carrasco, M. Sinkus, C.C. Reuter, L.W. Tsai, and D.A. Schooley.  
1987. Identification of a juvenile hormone-like compound in a crustacean. *Science* 235:202-205.
- Meusy, J.-J., G. Martin, D. Soyez, J.E. van Deijnen, and J.-M. Gallo.  
1987. Immunochemical and immunocytochemical studies of the crustacean vitellogenesis-inhibiting hormone (VIH). *Gen. Comp. Endocrinol.* 67:333-341.
- Mohamed, M.A., K.A. Lerro, and G.D. Prestwich.  
1989. Polyacrylamide gel miniaturization improves protein visualization and autoradiographic detection. *Anal. Biochem.* 177:287-290.
- Okazaki, R.K., and E.S. Chang.  
1991. Ecdysteroids in the embryos and sera of the crabs, *Cancer magister* and *C. anthonyi*. *Gen. Comp. Endocrinol.* 81:174-186.
- Panouse, J.  
1943. Influence de l'ablation du pédoncule oculaire sur la croissance de l'ovaire chez la Crevette *Leander serratus*. *Comptes Rendus Académie des Sciences, Paris* 217:553-555.  
1944. L'action de la glande du sinus sur l'ovaire chez la Crevette *Leander*. *Comptes Rendus Académie des Sciences, Paris* 218:293-294.
- Prestwich, G.D., M.J. Bruce, I. Ujváry, and E.S. Chang.  
1990. Binding proteins for methyl farnesoate in lobster tissues: detection by photoaffinity labeling. *Gen. Comp. Endocrinol.* 80:232-237.
- Quackenbush, L.S., and W.F. Herrnkind.  
1983. Partial characterization of eyestalk hormones controlling molt and gonadal development in the spiny lobster *Panulirus argus*. *J. Crustacean Biol.* 3:34-44.
- Quackenbush, L.S., and L.L. Keeley.  
1988. Regulation of vitellogenesis in the fiddler crab, *Uca pugilator*. *Biol. Bull. (Woods Hole)* 175:321-331.
- Rosenberry, B.  
1990. World shrimp farming 1989. *Aquaculture Digest*, San Diego, 28 p.
- Soyez, D., J.E. Van Deijnen, and M. Martin.  
1987. Isolation and characterization of a vitellogenesis-inhibiting factor from sinus glands of the lobster, *Homarus americanus*. *J. Exp. Zool.* 244:479-484.
- Spindler, K.-D., A. Van Wormhoudt, D. Sellos, and M. Spindler-Barth.  
1987. Ecdysteroid levels during embryogenesis in the shrimp, *Palaemon serratus* (Crustacea Decapoda): quantitative and qualitative changes. *Gen. Comp. Endocrinol.* 66:116-122.
- Ujváry, I., and G.D. Prestwich.  
1990. An efficient synthesis of the crustacean hormone [12-<sup>3</sup>H]-methyl farnesoate and its photolabile analog [13-<sup>3</sup>H]-farnesyl diazomethyl ketone. *J. Labelled Compd. & Radiopharm.* 28:167-174.
- Van Wormhoudt, A., P. Porcheron, and L. Le Roux.  
1986. Ecdystéroïds et synthèse protéique dans l'hépatopancréas de *Palaemon serratus* (Crustacea, Decapoda) au cours du cycle d'intermue. *Bull. Soc. Zool. Fr.* 110:191-204.



# Hormonal Control of Reproductive Maturation in Penaeid Shrimp

ISAO YANO

*National Research Institute of Aquaculture  
Nakatsuhama Nansei-cho,  
Mie 516-01, Japan*

## ABSTRACT

Control of reproductive maturation is a major problem to the development of commercial aquaculture programs for penaeid shrimp. Although hormonal control of maturation is well documented in oviparous vertebrates and insects, similar knowledge for crustaceans is fragmentary. It has long been suspected that reproductive maturation may be controlled by two antagonistic hormones, one that stimulates and the other that inhibits. Ovarian maturation in penaeid shrimp has been induced and accelerated by implantation of thoracic ganglion prepared from maturing female lobsters. This indicates that ovarian maturation may be induced by a gonad-stimulating hormone (GSH) secreted by the thoracic ganglion of maturing females. Many workers have reported that ovarian maturation is regulated by a gonad-inhibiting hormone (GIH) from the X organ-sinus gland complex. This GIH probably has an antagonistic relationship with GSH secreted by the thoracic ganglion. This paper further details our present understanding of the endocrine systems of penaeid shrimp and how they control reproductive maturation. It is suggested that the brain, mandibular organ, or ovary has a close relationship with the X organ-sinus gland complex or thoracic ganglion, which secrete GIH or GSH, in regulating ovarian maturation in penaeid shrimp.

## Introduction

---

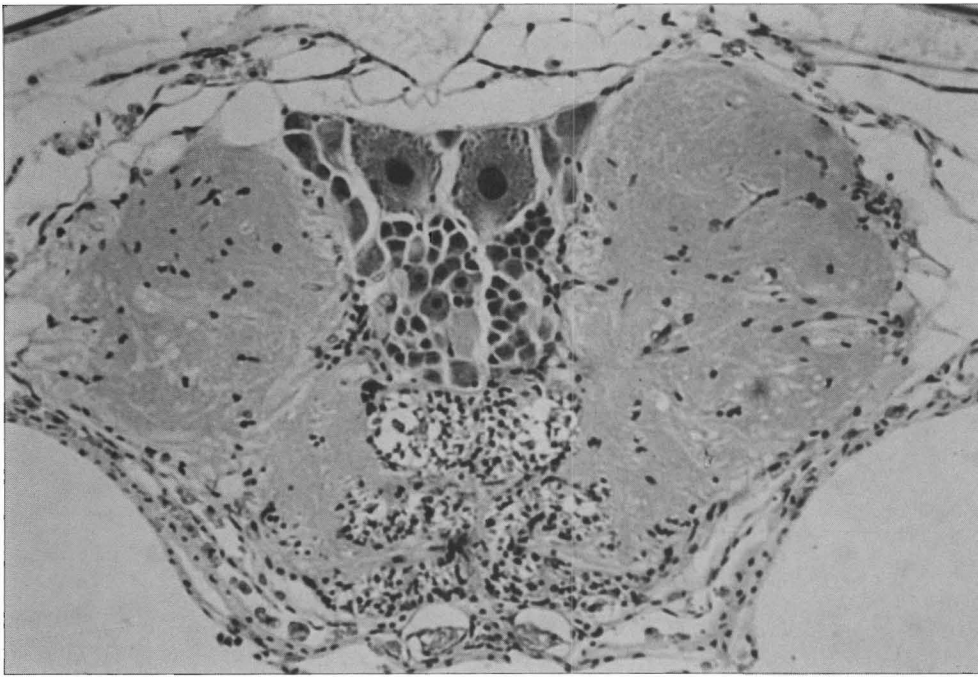
Control of reproductive maturation is a major problem to the development of commercial aquaculture programs for penaeid shrimp. Controlling reproduction in captivity could help to provide a reliable year-round supply of juveniles, serve in developing selective breeding programs, and be generally useful for obtaining disease-free spawners. Eystalk ablation has been used to mature female shrimp in captivity in conjunction with the management of water temperature, photoperiod, light intensity, areal density, sex ratio, and nutrition (Caillouet 1973; Lumare 1979; Yano 1984; Primavera 1985; Crocos and Kerr 1986). Knowledge of hormonal control of reproductive maturation in crustaceans, however, is fragmentary. Although many observations of endocrine systems have been conducted on the inhibition of reproductive maturation by eystalk hormone(s) since the pioneering work of the 1940s (Panouse 1943, 1944), recent research has focused mostly on organs (e.g., brain, thoracic ganglion, ovary, and mandibular organ) and their

functions, which are closely related with the release of gonad-stimulating factors or hormone(s) in crustaceans. This paper summarizes our present knowledge of the endocrine systems of penaeid shrimp and how they control reproductive maturation.

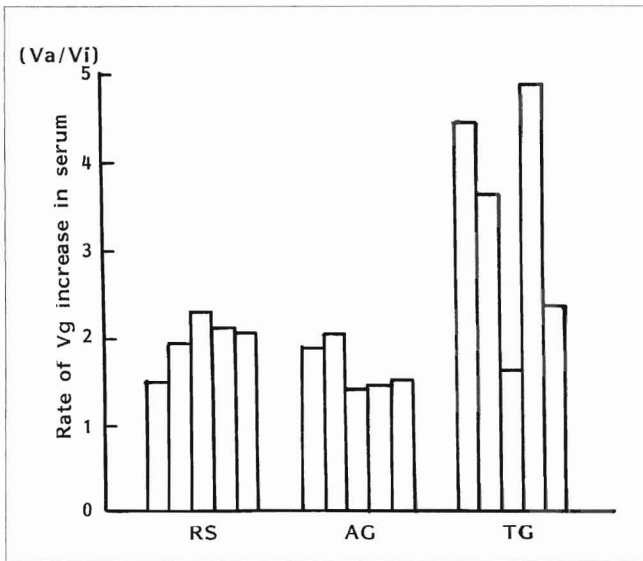
## Eystalk Hormone Effects on Maturation

---

Eystalk ablation stimulates ovarian maturation in penaeid shrimp, palinurid lobsters, and other decapod crustaceans (Caillouet 1973; Yano 1984; Yano, unpubl. data). This treatment reduces the production of a gonad-inhibiting hormone (GIH), and thus permits maturation of the ovaries in females. Many workers suggest that reproductive maturation in penaeid shrimp is regulated by a GIH from the X organ-sinus gland complex in the eystalks. In this complex, the acidophilic sinus gland is connected with the axons from the neurosecretory cell of the X organ, which is located in the medulla terminalis of penaeid shrimp (Yano, unpubl. data) and the other



**Figure 5**  
Thoracic ganglion, showing neurosecretory cells in *Penaeus japonicus*. Neurosecretory cells contained basophilic granules dispersed throughout the cytoplasm (Yano, unpubl. data). Haematoxylin and eosin stain,  $\times 65$ .

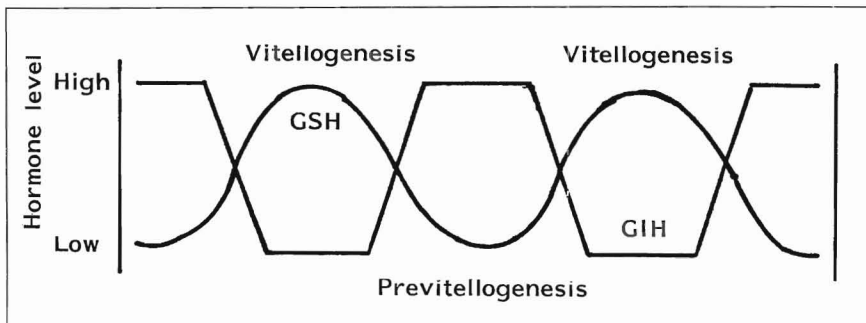


**Figure 6**

Rate of Vg increase in sera of maturing female *Penaeus japonicus*, 48 hours after injection of abdominal (AG) and thoracic ganglion (TG) extracts. Vi: Initial Vg concentration; Va: Vg concentration 48 hours after injection; RS: Ringer solution (Yano, unpubl. data).

antagonistic relationship with GIH in regulating vitellogenesis (Fig. 7). Unilateral eyestalk ablation was not effective in increasing serum Vg in maturing female *P. japonicus* (Fig. 8, Yano, unpubl. data). This suggests that GIH may decrease quickly immediately before the initiation of vitellogenesis and then stay at a low level until after the vitellogenesis is completed. Therefore, eyestalk ablation may no longer be effective in regulating the production of GIH after vitellogenesis has been initiated. On the other hand, injection of thoracic ganglion extract, prepared from vitellogenic females, was effective in increasing serum Vg, even in maturing females (Fig. 6). This indicates that after initiation of vitellogenesis, higher amounts of GSH, which are increased by injection of thoracic ganglion extract, accelerate Vg synthesis and its release into the blood. This implies the possibility that in penaeid shrimp, GSH levels may increase further with advancement of vitellogenesis, parallel to a decrease in the level of GIH (Fig. 7).

It is well known that biogenic amines release peptide neurohormones from neuroendocrine struc-



**Figure 7**

Model for the control of vitellogenesis in penaeid shrimp. Gonad-stimulating-hormone (GSH) probably has an antagonistic relationship with gonad-inhibiting-hormone (GIH) in regulating vitellogenesis.

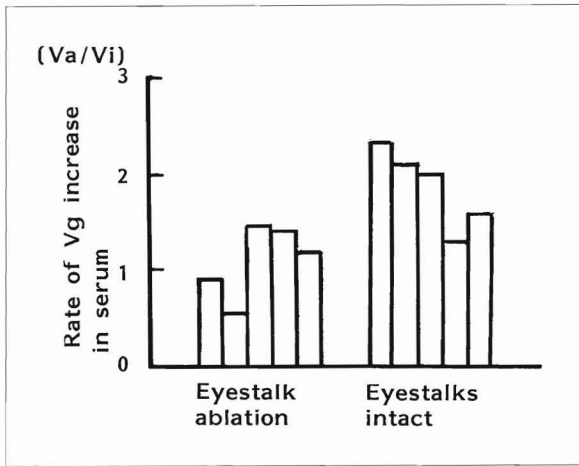


Figure 8

Rate of Vg increase in sera of maturing female *Penaeus japonicus*, 48 hours after unilateral eyestalk ablation. Vi: Initial Vg concentration; Va: Vg concentration 48 hours after injection (Yano, unpubl. data).

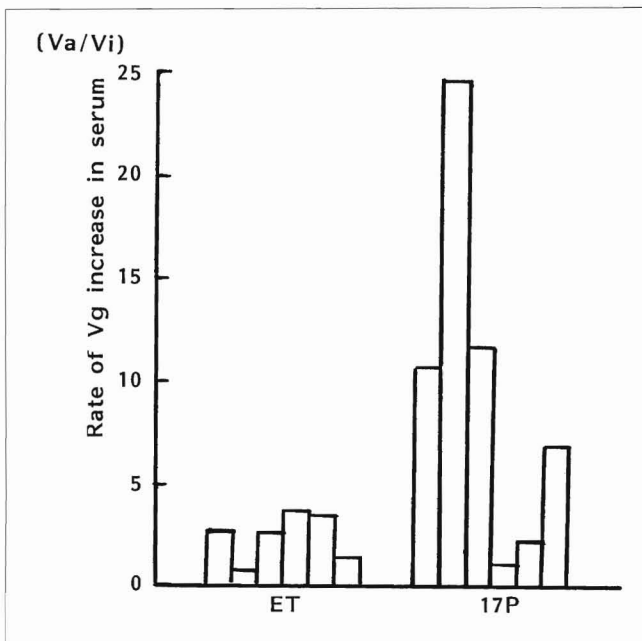


Figure 9

Rate of Vg increase in sera of control (0.1  $\mu\text{g}$  pure ethanol/g body weight) and treated female *Penaeus japonicus*, 48 hours after 17  $\alpha$ -hydroxy-progesterone (0.1  $\mu\text{g}$ /g body weight) injection. ET: Ethanol; 17P: 17  $\alpha$ -hydroxy-progesterone; Vi: Initial Vg concentration; Va: Vg concentration 48 hours after injection (Yano 1987a).

tures in several crustaceans (Fingerman 1985). Serotonin has been found to induce the release of molting-inhibiting hormone from isolated eyestalks (Mattson and Spaziani 1985). This implies the possibility that biogenic amines may stimulate the release

of GIH from the X organ-sinus gland complex in crustaceans.

Vitellogenin has been identified electrophoretically and immunologically in the haemolymph of vitellogenic female crustaceans (Horn and Kerr 1969; Fielder et al. 1971; Wolin et al. 1973; Fyffe and O'Connor 1974; Yano 1987a; Yashiro 1989). Therefore, extra-ovarian tissue has been suspected for a long time as the site of Vg synthesis in crustaceans. In fact, evidence has been presented to show that Vg is synthesized by the fat body or adipose tissue in amphipods and isopods (Picaud 1980; Croisille and Junera 1980; Souty and Picaud 1981). Recently, several workers demonstrated that Vg is synthesized on a large scale by the ovaries of crayfish (Lui et al. 1974), fiddler crabs, *Uca pugnator* (Eastman-Reks and Fingerman 1985), kuruma prawns (Yano and Chinzei 1987), and white prawns (Quackenbush 1989; Rankin et al. 1989). Considering these observations, the site of Vg synthesis in decapods is different from that in isopods and amphipods. Vitellogenin is secreted into the haemolymph after its synthesis and then accumulated in the developing oocytes as vitellin (Yano 1988). It is known that ecdysone, which is produced in the Y-organ, stimulates vitellogenesis in the isopod *Procellio dilatatus* and amphipod *Orchestia gammarella* (Souty et al. 1982; Blanchet-Tournier 1982; Charniaux-Cotton 1985). Recently, evidence has been presented to show that 17 $\alpha$ -hydroxy-progesterone stimulates Vg synthesis or release, or both, into the blood in kuruma prawns (Fig. 9; Yano 1987a), fresh water prawn, *Macrobrachium lanchesteri* (George and Khoo 1989), and black tiger shrimp, *P. monodon* (Yashiro 1989). The hormone 17  $\alpha$ -hydroxy-progesterone is generally distributed in the ovary of crustaceans (Kanazawa and Teshima 1971). Junera et al. (1977) deduced the existence of a Vg-stimulating ovarian hormone (VSOH) which controls vitellogenin synthesis in females of *O. gammarella*. It is probable that 17  $\alpha$ -hydroxy-progesterone stimulates Vg synthesis and release into haemolymph as a VSOH in penaeid shrimp and other shrimp (Fig. 10). By immunofluorescence, Vg was found to occur for the first time in the follicle cells of the oil globule stage-I oocytes in early developing ovaries, which actively synthesize Vg (Yano and Chinzei 1987). The follicle cells greatly expanded on the oil globule stage-I oocytes (Yano and Chinzei 1987; Yano 1988). Therefore, the follicle cells are nominated as a possible cell type responsible for ovarian Vg synthesis in kuruma prawns. It is suggested that 17  $\alpha$ -hydroxy-progesterone, probably secreted from the ovary as a VSOH, stimulates Vg synthesis in follicle cells and Vg release into the haemolymph in penaeid shrimp (Fig. 10). On the other hand, brain extracts, prepared from

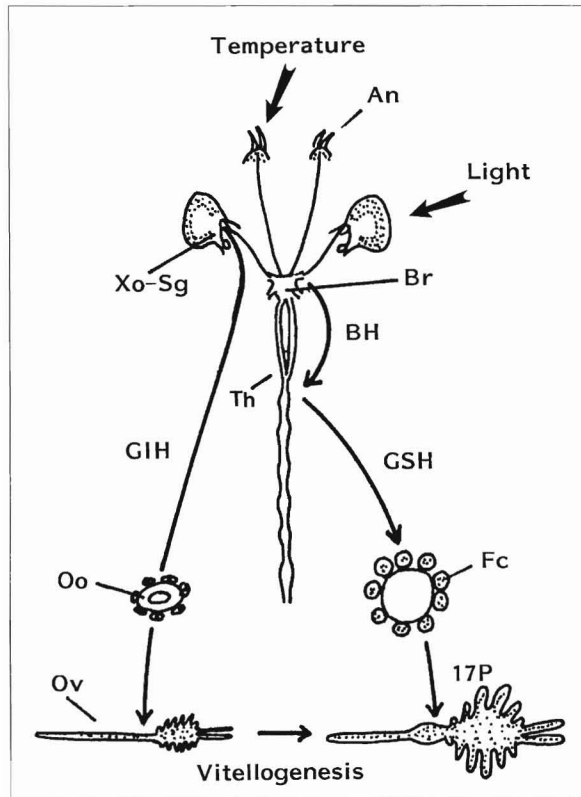


Figure 10

Scheme of the factors affecting vitellogenesis and associated endocrine patterns in penaeid shrimp. An: Antennule; Br: Brain; Xo-Sg: X organ-sinus gland complex; Th: Thoracic ganglion; Fc: Follicle cell; Oo: Oocyte; Ov: Ovary; BH: Brain hormone; GIH: Gonad-inhibiting hormone; GSH: Gonad-stimulating hormone; 17P: 17  $\alpha$ -hydroxyprogesterone.

maturing females induced Vg synthesis in *P. japonicus* (Yano, unpubl. data). This suggests the presence of a brain hormone that stimulates the release of GSH in penaeid shrimp (Fig. 10). Also, mandibular organ implantation could stimulate vitellogenesis in the spider crab *Libinia emarginata* (Hinsch 1980). Laufer et al. (1987) found that methyl farnesoate, an unepoxidated analog of the insect juvenile hormone III, was synthesized by the mandibular organ of spider crabs, *L. emarginata*. However, the function of methyl farnesoate is not known to control maturation in crustaceans.

### Temperature and Light Effects on Maturation

It is well known that ovarian maturation is affected by water temperature and photoperiod in female shrimp. A photoperiod of 14–16 hours (light) and temperature of 24–26° C stimulate ovarian maturation

in *P. japonicus* (Laubier-Bonichon 1978; Yano 1984). High temperature (25° C) and long daylength (15 hours) induce Vg synthesis and secretion into the blood in kuruma prawn (Yano 1987a). Lumare (1981) demonstrated that even in ablated *P. japonicus* full sexual maturation did not occur below 17° C. Increasing ovarian development and rapid maturation were observed as water temperature rose above 18° C (Yano 1987b). The change from 12 to 13 hours of daylight was also observed to accelerate the ovarian maturation (Yano 1987b). In unablated *P. monodon*, a longer photoperiod of 19 hours (light) did not stimulate ovarian maturation (Beard and Wickins 1980). These findings indicate that the effect of GSH and GIH on induction and inhibition of ovarian maturation or vitellogenesis is affected by water temperature and photoperiod in female shrimp. It is probable that the release of GSH and GIH from the thoracic ganglion and the X organ-sinus gland complex may be induced directly or indirectly by water temperature and light stimuli, via respectively the antennule (Barber 1961) and eye (Waterman 1961) in female penaeid shrimp, as shown in Figure 10.

### Citations

- Barber, S.B.  
1961. Chemoreception and thermoreception. *In* The physiology of Crustacea Vol. 2 (T.H. Waterman, ed.), p. 109–131. Acad. Press, NY.
- Beard, T.W., and J.F. Wickins.  
1980. Breeding of *Penaeus monodon* Fabricius in laboratory recirculation systems. *Aquaculture* 20:79–89.
- Bell, T. A., and D. V. Lightner.  
1988. Compound eye and associated organs. *In* A handbook of normal penaeid shrimp histology, p. 26–33. World Aquaculture Society, Baton Rouge, LA.
- Blanchet-Tournier, M.F.  
1982. Quelques aspects des interactions hormonales entre la mue et la vitellogenesis chez le Crustace Amphipode *Orchestia gammarella* (Pallas). *Reprod. Nutr. Dev.* 22:325–344.
- Bomirski, A.M., A.E. Kawinska, and L. H. Kleinholz.  
1981. Partial characterization of crustacean gonad-inhibiting hormone. *Int. J. Invertebr. Reprod.* 3:213–220.
- Caillouet, C.W.  
1973. Ovarian maturation by eyestalk ablation in pink shrimp *Penaeus duorarum* Burkenroad. *Proc. World Maricul. Soc.* 3:205–225.
- Carlisle, D.B., and F.K. Bart.  
1959. The neurosecretory system of the head and thorax. *In* Endocrine control in crustaceans (M. Abercrombie, P. B. Medawar, and G. Sal, eds.), p. 13–39. The Univ. Press, Cambridge.
- Charniaux-Cotton, H.  
1985. Vitellogenesis and its control in malacostracan Crustacea. *Am. Zool.* 25:197–206.
- Crococ, P.J., and J.D. Kerr.  
1986. Factors affecting induction of maturation and spawning of the tiger prawn, *Penaeus esculentus* (Haswell), under laboratory conditions. *Aquaculture* 58:203–214.

- Croisille, Y., and H. Junera.  
1980. Recherche du lieu de synthese de la vitellogenine chez le Crustace amphipode *Orchestia gammarella* (Pallas). Demonstration, a l'aide d'anticorpos specifiques, de la presence de vitellogenine dans le tissu adipeux sous-epidermique de femaelles en vitellogenese secondaire. C. R. Acad. Sci., Paris 290:1487-1490.
- Eastman-Reks, S., and M. Fingerman.  
1984. Effects of neuroendocrine tissue and cyclic-AMP on ovarian growth in vivo and in vitro in the fiddler crab, *Uca pugilator*. Comp. Biochem. Physiol. 79A:679-684.  
1985. In Vitro synthesis of vitellin by the ovary of the fiddler crab, *Uca pugilator*. J. Exp. Zool. 233:111-116.
- Fielder, D.F., K.K. Rao, and M. Fingerman.  
1971. A female-limited lipoprotein and the diversity of hemosyanin components in the dimorphic variants of the fiddler crab, *Uca pugilator*, as revealed by disc electrophoresis. Comp. Biochem. Physiol. 39B:291-297.
- Fingerman, M.  
1985. The physiology and pharmacology of crustacean chromatophores. Am. Zool. 25:233-252.
- Fyffe, W.E., and J.D. O'Connor.  
1974. Characterization of quantification of a crustacean lipovitellin. Comp. Biochem. Physiol. 47B:851-867.
- George, S., and H.W. Khoo.  
1989. Effects of estrogens and progesterones on vitellogenin levels in the haemolymph of the shrimp, *Macrobrachium lanchesteri*. In Abstracts of the Fifth International Congress of Invertebrate Reproduction; 23-28 July 1989, Nagoya, Japan, p. 57. Publ. by Int. Soc. Invert. Reprod., Mainz, Germany.
- Hagedorn, H.H., and J.G. Kunkel.  
1979. Vitellogenin and vitellin in insects. Annu. Rev. Entomol. 24:475-505.
- Hinsch, G.W.  
1980. Effect of mandibular organ implants upon the spider crab ovary. Trans. Am. Microsc. Soc. 99:317-322.
- Hinsch, G.W., and D.C. Bennett.  
1979. Vitellogenesis stimulated by thoracic ganglion implants into destalked immature spider crab, *Libinia emarginata*. Tissue & Cell 11:345-351.
- Horn, E.C., and M.S. Kerr.  
1969. The haemolymph protein of the blue crab, *Callinectes sapidus*. I. Hemocyanins and certain other major protein constituents. Comp. Biochem. Physiol. 29:493-508.
- Junera, H., C. Zerbib, M. Martin, and J.J. Muesy.  
1977. Evidence for control of vitellogenin synthesis by an ovarian hormone in *Orchestia gammarella* (Pallas), Crustacea, Amphipoda. Gen. Comp. Endocrinol. 31:457-462.
- Kanazawa, A., and S. Teshima.  
1971. In vivo conversion of cholesterol to steroid hormones in the spiny lobster, *Panulirus japonicus*. Bull. Jpn. Soc. Fish. 37:891-898.
- Laubier-Bonichon, A.  
1978. Ecophysiologie de la reproduction chez la crevette *Penaeus japonicus* trois annees d'experience en milieu controle. Oceanol. Acta. 1:135-150.
- Laufer, H., D. Borst, F.C. Baker, C. Carrasco, M. Sinkus, C. Reuter, L.W. Tsai, and D.A. Schooley.  
1987. The identification of a juvenile hormone-like compound in a crustacean. Science 235:202-205.
- Lui, C.W., B.A. Sage, and J.D. O'Connor.  
1974. Biosynthesis of lipovitellin by the crustacean ovary. J. Exp. Zool. 188:289-296.
- Lumare, F.  
1979. Reproduction of *Penaeus kerathurus* using eyestalk ablation. Aquaculture 18:203-214.
1981. Artificial reproduction of *Penaeus japonicus* Bate as basis for commercial production of eggs and larvae. J. World Maricul. Soc. 12:335-344.
- Mattson, M. P., and E. Spaziani.  
1985. 5-hydroxytryptamine mediated release of molt-inhibiting hormone activity from isolated crab eyestalk ganglia. Biol. Bull. (Woods Hole) 169:246-255.
- Meusy, J.-J., G. Martin, D. Soye, J.E. van Deijnen, and J.-M. Gallo.  
1987. Immunochemical and immunocytochemical studies of the crustacean vitellogenesis-inhibiting hormone (VIH). Gen. Comp. Endocrinol. 67:333-341.
- Otsu, T.  
1960. Precocious development of the ovaries in the crab, *Potamon dehaani*, following implantation of the thoracic ganglion. Annot. Zool. Jpn. 33:90-96.
- Oyama, S.N.  
1968. Neuroendocrine effects on ovarian development in the crab *Thalamita crenata* Latreille studied in vitro. Ph. D. diss., Univ. Hawaii, Honolulu, Hawaii.
- Panouse, J. B.  
1943. Influence de l'ablation du preonucle oculaire sur la croissance de l'ovaire chez la crevette *Leander serratus*. C. R. Acad. Sci., Paris 217:553-555.  
1944. L'action de la glande du sinus sur l'ovaire chez la crevette *Leander*. C. R. Acad. Sci., Paris 218:293-294.
- Picaud, J.-L.  
1980. Vitellogenin synthesis by the fat body of *Porcelio dilatatus* Brandt (Crustacea, Isopoda). Int. J. Invertebr. Reprod. 2:341-349.
- Primavera, J.H.  
1985. A review of maturation and reproduction in closed thelycum penaeids. In Proceedings of the first international conference on the culture of penaeid prawns/shrimps; 4-7 December 1984, Iloilo City, The Philippines (Y. Taki, J.H. Primavera, and J.A. Llobrera, eds.), p 47-64. Japan Int. Cooper. Agency, Tokyo, Japan.
- Quackenbush, L.S.  
1989. Yolk protein production in the marine shrimp *Penaeus vannamei*. J. Crustacean Biol. 9:509-516.
- Quackenbush, L. S., and W. F. Herrnkind.  
1983. Partial characterization of eyestalk hormone controlling molt and gonadal development in the spiny lobster, *Panulirus argus*. J. Crustacean Biol. 3:34-44.
- Rankin, S.M., J.Y. Bradfield, and L.L. Keeley.  
1989. Ovarian protein synthesis in the South American white shrimp, *Penaeus vannamei*, during the reproductive cycle. Int. J. Invertebr. Reprod. 15:27-33.
- Souty, C., and J.L. Picaud.  
1981. Vitellogenin synthesis in the fat body of the marine crustacea isopoda, *Idotea balthica* basteri, during vitellogenesis. Reprod. Nutr. Dev. 21:95-102.
- Souty, C., G. Besse, and J.-L. Picaud.  
1982. Ecdysone stimulates the rate of vitellogenin release in haemolymph of the terrestrial crustacean Isopoda *Porcellio dilatatus* Brandt. C.R. Acad. Sci., Paris, 294:1057-1060.
- Takayanagi, H., Y. Yamamoto, and N. Takeda.  
1986. An ovary stimulating factor in the shrimp, *Paratya compressa*. J. Exp. Zool. 240:203-209.
- Tata, J.R.  
1978. Induction and regulation of vitellogenin synthesis by estrogen. In Biochemical actions of hormones, Vol. 5 (G. Litwack, ed.), p. 397-431 Acad. Press, NY.
- Waterman, T.H.  
1961. Light sensitivity and vision. In The physiology of Crustacea, Vol. 2 (T.H. Waterman, ed.), p. 1-64. Acad. Press, NY.

- Wolin, E.H., H. Laufer, and D.F. Albertini.  
1973. Uptake of the yolk protein lipovitellin by developing crayfish oocytes. *Dev. Biol.* 35:160-170.
- Yano, I.  
1984. Induction of rapid spawning in kuruma prawn, *Penaeus japonicus*, through unilateral eyestalk enucleation. *Aquaculture* 40:265-268.  
1987a. Effect of 17  $\alpha$ -hydroxy-progesterone on vitellogenin secretion in kuruma prawn, *Penaeus japonicus*. *Aquaculture* 61:49-57.  
1987b. Maturation of kuruma prawns *Penaeus japonicus* cultured in earthen ponds. In *Reproduction, maturation and seed production of cultured species: proceedings of the twelfth U.S.-Japan meeting on aquaculture; 25-29 October 1983, Baton Rouge, LA* (C.J. Sinderman, ed.), p. 3-7. NOAA Tech. Rep. NMFS 47.  
1988. Oocyte development in the kuruma prawn *Penaeus japonicus*. *Mar. Biol. (Berlin)* 99:547-553.
- Yano, I., and Y. Chinzei.  
1987. Ovary is the site of vitellogenin synthesis in kuruma prawn, *Penaeus japonicus*. *Comp. Biochem. Physiol.* 86B:213-218.  
1990. Effects of human chorionic gonadotropin and unilateral eyestalk enucleation on vitellogenin induction and ovary development in kuruma prawn, *Penaeus japonicus*. In *Shrimp culture in the world* (C.C. Justo, ed.), p. 365-370. Midori Shohou, Tokyo, Japan.
- Yano, I., B. Tsukimura, J.N. Sweeney, and J.A. Wyban.  
1988. Induced ovarian maturation of *Penaeus vannamei* by implantation of lobster ganglion. *J. World Aquacult. Soc.* 19:204-209.
- Yashiro, R.  
1989. Biochemical, immunological and histological studies on ovarian maturation and rematuration of *Penaeus monodon* Fabricius. Ph.D. diss., Univ. Philippines System. Quezon City, Philippines.

# Reproductive Physiology and Induced Spawning of Yellowtail (*Seriola quinqueradiata*)

HIROHIKO KAGAWA

National Research Institute of Aquaculture  
Nansei  
Mie 516-01, Japan

## ABSTRACT

For the large-scale production of the yellowtail *Seriola quinqueradiata* an understanding of its reproductive physiology and the ability to artificially control its reproduction are necessary. This article briefly reviews recent studies on the reproductive physiology and hormonally induced spawning of the yellowtail. Plasma steroid hormone levels associated with ovarian development and the results of spawning induced by using human chorionic gonadotropin and gonadotropin releasing hormone are discussed.

## Introduction

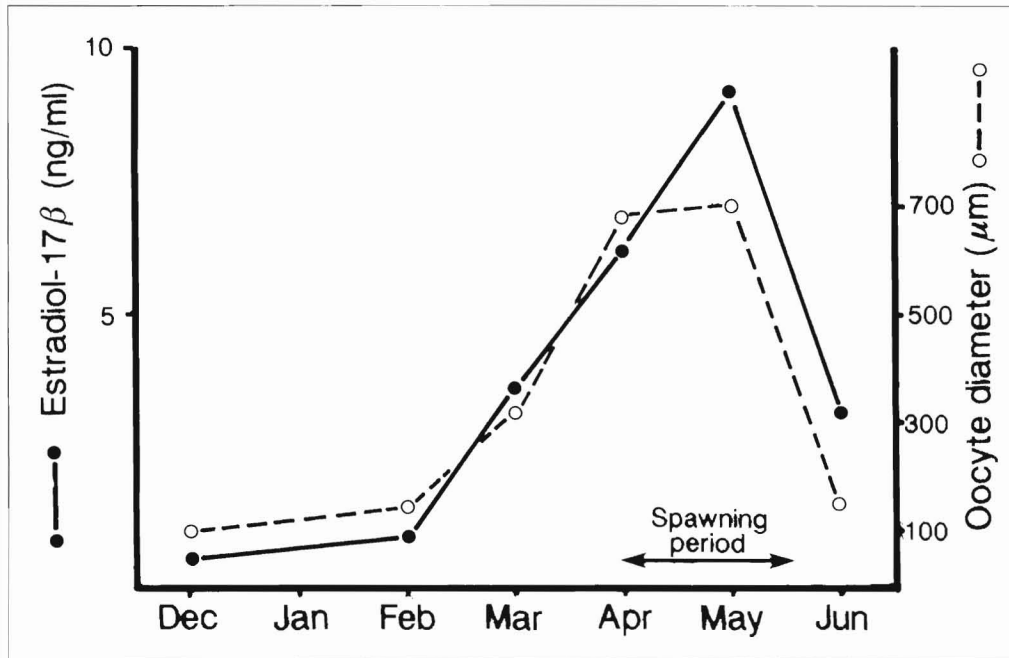
In Japan, the yellowtail *Seriola quinqueradiata* is one of the most highly regarded fish species for fresh consumption. In addition, its suitability for marine aquaculture is good. The annual production of cultured yellowtail currently amounts to about 165,000 metric tons (approximately 70% of total production of marine finfish aquaculture; DSI 1988). Currently, wild juvenile fish are caught as seed for aquaculture. For the large-scale production of the yellowtail and stable production of seed, an understanding of its reproductive physiology and the ability to control its reproduction are necessary. This article briefly reviews recent studies on the reproductive physiology and hormonally induced spawning of yellowtail.

## Reproductive Physiology

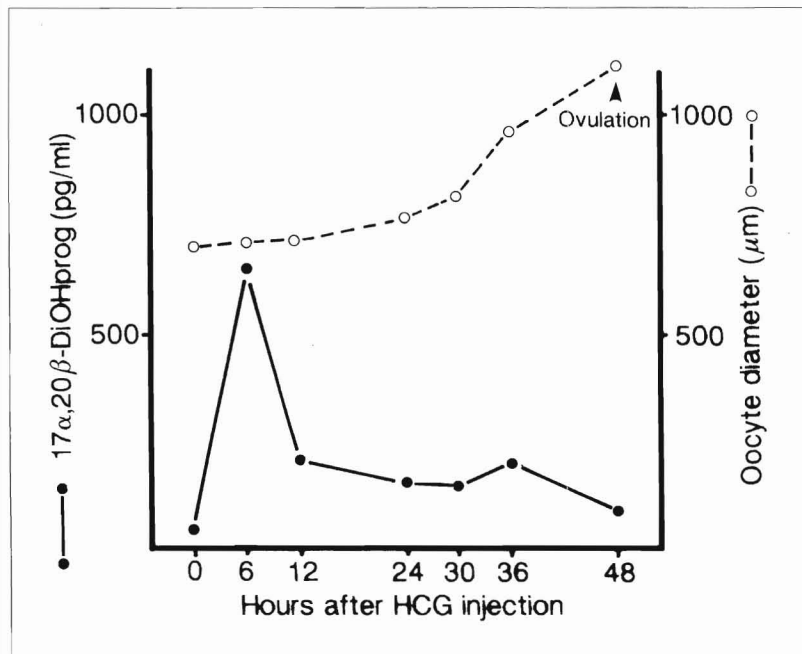
After the fry stage, female yellowtail normally attain sexual maturity in floating net pens in about three years. Oocyte diameter begins increasing in February. The most advanced oocytes rapidly increase their diameter after vitellogenesis starts in March and reach about 700  $\mu\text{m}$  at the tertiary yolk globule stage in April (Fig. 1). The yellowtail has an asynchronous-type ovary which contains oocytes at various developmental stages ranging from the perinucleolus to tertiary yolk globule stage in the spawning season

(April and May). Since yolky oocytes still remain in the ovary after ovulation, yellowtail appear to be capable of multiple spawnings during a spawning season.

It is well known that estradiol-17 $\beta$  induces vitellogenin synthesis in the teleost liver. The increase in plasma estradiol-17- $\beta$  levels correlates well with increase of gonadal weights (Kagawa et al. 1983). Changes in plasma estradiol-17 $\beta$  levels in yellowtail (Fig. 1) also correlate with the development of the ovary; estradiol-17 $\beta$  levels are constantly low (below 1 ng/mL) in the previtellogenic stage from December to February and increase rapidly during the vitellogenic period reaching a maximum level in the spawning season at a concentration of about 9 ng/mL (Kagawa et al., unpubl. data). These values found in female yellowtail are of the same order as those reported for other fish that have asynchronous-type ovaries (goldfish, *Carassius auratus*, Kagawa et al. 1983; common carp, *Cyprinus carpio*, Santos et al. 1986). The compound 17 $\alpha$ , 20 $\beta$ -dihydroxy-4-pregnen-3-one (17 $\alpha$ , 20 $\beta$ -diOHprog) was first identified as a maturation-inducing steroid in amago salmon *Oncorhynchus rhodurus* (Nagahama 1987) and has been known to induce final oocyte maturation in many other fish. Plasma levels of this steroid dramatically increased at the time of oocyte maturation in many teleost species. In yellowtail, an increase of 17 $\alpha$ , 20 $\beta$ -diOHprog (Fig. 2) was also observed during the final oocyte maturation that was induced using hu-



**Figure 1**  
Changes in plasma estradiol-17 $\beta$  levels and oocyte diameter during the oocyte development in the yellowtail (Kagawa et al., unpubl. data).



**Figure 2**  
Changes in plasma 17 $\alpha$ , 20 $\beta$ -dihydroxy-4-pregnen-3-one (17 $\alpha$ , 20 $\beta$ -diOHprog) levels and oocyte diameter in the yellowtail after injection of human chorionic gonadotropin (Kagawa et al., unpubl. data).

man chorionic gonadotropin (HCG) injection (Kagawa et al., unpubl. data). Values for plasma 17 $\alpha$ , 20 $\beta$ -diOHprog obtained from yellowtail are on the same order as those reported for goldfish (Kagawa et al. 1983), but are very low compared with those reported in salmonids (Young et al. 1983). The difference between plasma 17 $\alpha$ , 20 $\beta$ -diOHprog levels of yellowtail and salmonids may be due to the lower capacity of the yellowtail ovarian follicle to produce this steroid as was suggested in goldfish (Kagawa et al. 1983). It is still uncertain whether 17 $\alpha$ , 20 $\beta$ -

diOHprog is the maturation inducing steroid in yellowtail. Further studies on in vitro effect of this steroid on oocyte maturation and its production in the ovarian follicles are necessary.

There is little information on the reproductive physiology of male yellowtail. Males mature very early; sperm formation can be observed in the testis of fish only 1 year old. Little attention has been paid to the collection of milt for fertilization because sperm formation occurs naturally even under net-culture conditions. The only attempt to control male



**Table 1**

Number of ovulated eggs, fertilization rates, and hatching rates in the yellowtail treated with single intramuscular injection of human chorionic gonadotropin.

Experiment number	No. of fish used	No. of fish ovulated	No. of eggs ovulated	% of fert.	% of hatching
1	3	3	1,710,000	49.1	14.6
2	15	13	9,900,000	69.6	49.8
3	17	14	4,460,000	72.6	51.1
4	15	11	7,290,000	62.5	39.2
5	11	10	8,210,000	32.5	21.2

**Table 2**

Number of spawned eggs, fertilization rates, and hatching rates in the yellowtail implanted with cholesterol pellet containing the gonadotropin releasing hormone analog.

Spawning date	No. of spawned eggs	% fertilized	% hatched
May 1	217,000	71.4	71.4
2	630,000	41.6	41.6
3	882,000	25.9	25.9
4	623,000	52.1	27.3
5	1,477,000	16.1	8.8
6	2,212,000	12.2	4.9
8	949,000	19.7	8.7
9	2,562,000	13.5	7.5
11	98,000	0	0

reproductive physiology is the use of a single injection of HCG two days before fertilization, to ensure that a sufficient volume of milt is collected.

### Induced Spawning

Although female yellowtail have ovaries that contain oocytes at the tertiary yolk stage (just prior to final oocyte maturation) during the spawning season, they do not ovulate and spawn in the floating net pens naturally. It has been known that HCG induces spawning in many fish including marine species, such as sea bream *Sparus aurata* (Gordin and Zohar 1978). In cultured female yellowtail (mean body weight 8.6 kg), ovulation is induced by a single intramuscular injection of HCG at a dose of 600–700 IU/kg body weight ( $\approx$  6,000 IU/fish). After HCG treatment, ovulation occurred within 24 to 48 hours. For practical purposes eggs were collected between 50 and 60 hours after HCG injection by manually stripping their abdomen. The number of eggs obtained by HCG treatment (Table 1) averaged about 500,000/fish.

Eggs were fertilized using milt from male fish treated with 6,000 IU of HCG two days before fertilization. Fertilized eggs were then incubated in a 1-ton tank for 2 days at 20° C. The mean fertilization rate was about 60% and the hatch rate was about 40%. Ovulation, fertilization, and hatch rates varied with the fish used because ovarian maturity at the time of injection was often different between fish. Their ovaries often contained many degenerated oocytes and only a few oocytes at the tertiary yolk stage. Assessment of ovarian maturity by cannulating oocytes from the fish before hormone treatment will improve these results.

As mentioned earlier, yellowtail have a potential to spawn several times during a spawning season; however, they do not spawn again if ovulation is induced by HCG injection. One of the most important reasons for this phenomenon is the stress incurred by handling while they are injected with hormone and their abdomens stripped to obtain ovulated eggs. These stressful treatments probably induce the degeneration of yolky oocytes. Gonadotropin releasing hormone (GnRH) and its analog are used successfully to induce spawning in a variety of fish (Marte et

al. 1988). Recently in our laboratory, attempts to use an implanted GnRH analog pellet to reduce the amount of handling and induce multiple natural spawning have been started.

Seven female yellowtail (mean body weight 8.0 kg) were implanted with a cholesterol pellet of gonadotropin-releasing-hormone analog, des Gly<sup>10</sup> [D-Ala<sup>6</sup>] LHRH ethylamide (Sigma) 1,000 µg/fish on 29 April. Cholesterol pellets (2 × 5 mm in size) which were composed of cholesterol powder, cocoa butter, and GnRH-analog were intramuscularly implanted. Females were reared with seven males in a 60 m<sup>3</sup> tank and the spawned eggs were collected by net every morning. Collected eggs were incubated in a 1-ton tank for 2 days at 20° C.

Preliminary results (Table 2) show that implantation of a cholesterol pellet containing GnRH analog induced natural spawning. Yellowtail spawned eggs over 11 days; fertilization and hatch rates were relatively high during the first 4 days but decreased rapidly from day 5—even though the number of spawned eggs increased. In this experiment, we could not know how many times one fish spawned during the experiment. Total number of spawned eggs by the GnRH-analog treated fish (1,378,000 eggs/fish) was more than twice that of HCG-injected fish (500,000 eggs/fish). Thus, it is possible that some fish probably spawned more than twice during the experiment. Because fertilization and hatching rates rapidly decreased during the experiment, further studies are necessary to improve the techniques for obtaining eggs of high quality.

### Acknowledgment

Thanks is extended to the staffs of the Komame (Kochi Prefecture) and Goto (Nagasaki Prefecture)

Branches of the Japan Sea-Farming Association for their kind collaboration and technical assistance in performing this work. A part of the data in this paper has already been published in the Annual working reports of the Japan Sea-Farming Association (Shinko Bldg., 2-1, Kanda Ogawa-cho, Chiyoda-ku, Tokyo 101 1987). Unpublished data from this laboratory is a result of collaboration with K. Hirose and S. Arai who are gratefully acknowledged.

### Citations

- Department of Statistical Information (DSI)  
1988. Fisheries Statistics of Japan, 142 p. DSI, Ministry of Agriculture, Forestry, and Fisheries, Government of Japan.
- Gordin, H., and Y. Zohar.  
1978. Induced spawning of *Sparus aurata* by means of hormonal treatment. Ann. Biol. Anim. Biochem. Biophys. 18:985-990.
- Kagawa, H., G. Young, and Y. Nagahama.  
1983. Changes in plasma steroid hormone levels during gonadal maturation in female goldfish *Carassius auratus*. Nippon Suisan Gakkaishi 49:1783-1787.
- Marte, C.L., N. Sherwood, L. Crim, and J. Tan.  
1988. Induced spawning of maturing milkfish (*Chanos chanos*) using human chorionic gonadotropin and mammalian and salmon gonadotropin releasing hormone analog. Aquaculture 73:333-340.
- Nagahama, Y.  
1987. 17α, 20β-Dihydroxy-4-pregnen-3-one: A teleost maturation-inducing hormone. Dev. Growth & Differ. 29:1-12.
- Santos, A.J.G., K. Furukawa, K. Bando, K. Aida, and I. Hanyu.  
1986. Photoperiodic determination of preovulatory gonadotropin surge on set time in the carp *Cyprinus carpio*. Nippon Suisan Gakkaishi 57:1167-1172.
- Young, G., L. Crim, H. Kagawa, A. Kambegawa, and Y. Nagahama.  
1983. Plasma 17α,20β-dihydroxy-4-pregnen-3-one levels during sexual maturation of amago salmon (*Oncorhynchus rhodurus*): Correlation with plasma gonadotropin and *in vitro* production by ovarian follicles. Gen. Comp. Endocrinol. 51:96-105.

# Gametogenesis of Triploid Bivalves with Respect to Aquaculture

KATSUHIKO T. WADA AND AKIRA KOMARU

*National Research Institute of Aquaculture*

*Nansei*

*Mie 516-01, Japan*

## ABSTRACT

Triploid bivalves have been induced in many species and are expected to be better in quality than diploid animals in aquaculture in relation to retarded gametogenesis (Stanley et al. 1981; Allen et al. 1982, 1986). Recently however, triploids of some bivalve species have been reported to mature and to produce active sperm and ripe eggs. This paper deals with the gametogenesis in triploid bivalves with respect to resolving problems associated with their release when they are introduced into intensive culture in the sea. We have been studying triploids of the Japanese pearl oyster *Pinctada fucata martensii* (Uchimura et al. 1989; Wada et al. 1989; Komaru and Wada 1990) and the scallop *Chlamys nobilis* (Komaru et al. 1988). Gametogenesis proceeds very differently in these two species as seen during the seasonal histological observation of gonads. Retardation of maturation was observed in both sexes of the triploid scallop: neither sperm nor mature eggs were detected (Komaru and Wada 1989). However, some triploid pearl oysters produced sperm and ripe eggs in gonads that were less developed than those of diploids (Komaru and Wada 1990). Sperm dissected from some of the triploid pearl oysters were active during microscopic examination. The eggs dissected from triploids showed germinal vesicle breakdown after treatment with ammonium sea water as seen in diploid eggs. Sperm from triploid pearl oysters had about 1.3 times higher mean values and a wider distribution range of relative DNA contents than those from diploids. We have not observed the spawning of triploid pearl oysters in the histological observation of animals cultured under natural conditions (Wada and Komaru unpubl. data). However, in the oyster *Crassostrea gigas*, abnormal DNA-content values of sperm dissected from triploids have been reported and the possibility of genetic abnormality was suggested in the D-shaped larvae. This genetic abnormality may have resulted from the insemination of normal eggs from a diploid female with sperm dissected from a triploid male (Allen 1987; Allen and Downing 1990; Akashige 1990). In the natural area occupied by the intensive cultures, it is necessary to avoid genetic abnormality in the zygotes from the triploids because such a zygote might affect the native stocks. If triploid animals release functional gametes to the sea, they should be cultured in a restricted and closed area to avoid damage to natural reproduction. Another proposal may be the introduction of triploids of exotic species into areas of the sea that they do not currently inhabit and where growth of the species could be expected after the introduction.

## Citations

Akashige, S.

1990. Growth and reproduction of triploid Japanese oyster in Hiroshima Bay. *In* Proceedings of the fifth international congress of invertebrate reproduction; 23–28 July 1989, Nagoya (M. Hoshi and O. Yamashita eds.), p. 461–468. Elsevier, Amsterdam.

Allen, S.K., Jr.

1987. Gametogenesis in three species of triploid shellfish: *Mya arenaria*, *Crassostrea gigas* and *Crassostrea virginica*. *In*

Proc. world symp. on selection, hybridization and genetic engineering in aquaculture, Vol. II; (K. Tiews ed.), p. 208–217. Bordeaux, 27–30 May 1986. Heeneman Verlagsgesellschaft, Berlin.

Allen, S.K. Jr., P.S. Gagnon, and H. Hidu

1982. Induced triploidy in the soft-shell clams: cytogenetic and allozymic confirmation. *J. Hered.* 73:421–428.

Allen, S.K. Jr., H. Hidu, and J. G. Stanley

1986. Abnormal gametogenesis and sex ratio in triploid soft-shell clams (*Mya arenaria*). *Biol. Bull. (Woods Hole)* 170:198–210.

- Allen, S. K. Jr., and S. L. Downing  
1990. Performance of triploid Pacific oysters, *Crassostrea gigas*: gametogenesis. *Can. J. Fish. Aquat. Sci.* 47:1213-1222.
- Komaru, A. and K. T. Wada  
1989. Gametogenesis and growth of induced triploid scallops *Chlamys nobilis*. *Nippon Suisan Gakkaishi* 55:447-452.
1990. Gametogenesis of triploid Japanese pearl oyster, *Pinctada fucata martensii*. In Proceedings of the fifth international congress of invertebrate reproduction; 23-28 July 1989, Nagoya (M. Hoshi and O. Yamashita eds.), p. 469-474. Elsevier, Amsterdam.
- Komaru, A., Y. Uchimura, H. Ieyama and K. T. Wada  
1988. Detection of induced triploid scallop, *Chlamys nobilis*, by DNA microfluorometry with DAPI staining. *Aquaculture* 69:201-209.
- Stanley, J.G., S. K. Allen, Jr. and H. Hidu  
1981. Polyploidy induced in the American oyster, *Crassostrea virginica*, with cytochalasin B. *Aquaculture* 23:1-10.
- Uchimura, Y., A. Komaru, K. T. Wada, H. Ieyama, M. Yamaki, and H. Furuta  
1989. Detection of induced triploidy at the different ages of larvae of the Japanese pearl oyster, *Pinctada fucata martensii* by microfluorometry with DAPI staining. *Aquaculture* 76:1-9.
- Wada, K. T., A. Komaru and Y. Uchimura  
1989. Triploid production in the Japanese pearl oyster, *Pinctada fucata martensii*. *Aquaculture* 76:11-19.

# Increasing the Growth Rate of Abalone, *Haliotis discus hannai*, using Selection Techniques

MOTUYUKI HARA AND SHOGO KIKUCHI

Tohoku Regional Fishery Research Laboratory  
3-27-5 Shinhama, Shiogama  
Miyagi 985, Japan

## ABSTRACT

Recently, a large number of abalone, *Haliotis discus hannai*, seeds have been produced by artificial fertilization and cultured in Japan. Most of the seeds have been released into the sea to increase abalone resources. However, some people have tried to continue the cultivation of the abalone seeds to commercial size in tanks. These efforts have been economically unsuccessful because of the typically low growth rate of this species. Therefore, it is necessary to improve their growth genetically. The genetic variation among lots of the seeds produced from different parents were examined. Differences in growth among the lots were observed for 190 days during rearing in the same tank. Moreover, to test the association between growth and isozyme genes, the *C*-allele frequency at the *Pgm-1* locus was compared between the large and small shell size classes. A higher frequency in the large shell size class was observed in 8 of 11 lots. This result suggests that growth in abalone is closely related to genetic factors. We also attempted to genetically improve abalone. By selecting and reculturing the fastest growing individuals for two generations in small scale culture in our laboratory. The results suggest a possibility of improving the growth rate of cultured abalone using selection techniques.

## Introduction

---

Presently, many marine species are produced by artificial fertilization and are cultured in Japan. One of the most important species is abalone. Twenty to thirty million abalone seeds are produced every year by over fifty farming centers (DSI 1990). Most of the seeds are cultured to the size of 10–30 mm in shell length then released into the sea in order to increase the abalone resource. Some people have tried to continue the cultivation of abalone seeds to commercial size in tanks; however these efforts have not been economically successful to date because the seeds exhibited low growth rates. Therefore, it is necessary to improve growth genetically. Artificial spawning techniques, diets for juveniles, and rearing equipment needed for abalone culture have been researched for more than 20 years (Kikuchi and Uki 1974; Takahashi and Koganezawa 1988 ; Uki 1989), but the genetic characters of artificial seed have been not

studied at all. It is known that variations in the shell size exist within and between lots of abalone seed. Such a phenomenon could be caused by both genetic differences and environmental differences such as food, temperature, and density of individuals.

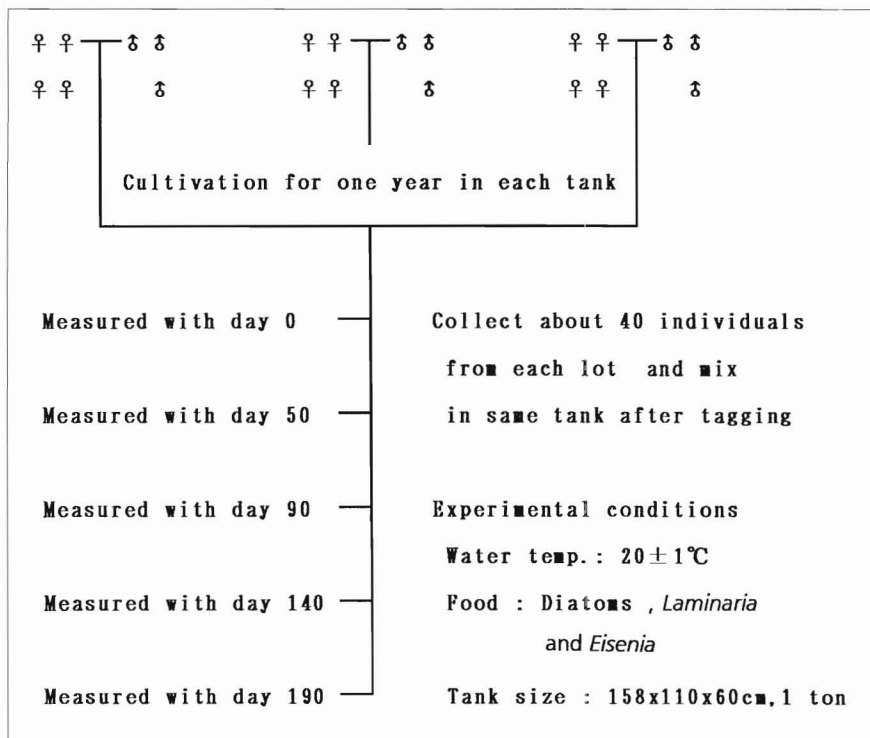
## Estimation of the Parental Effects on Growth

---

We reared several lots of abalone (*Haliotis discus hannai*) seed in the same tank and compared the growth of individuals. Plastic film tags (Hara 1989) were used to identify individuals under the culture conditions. The influence of the tagging on growth was tested. At the beginning of this study (day 0), the mean shell length of tagged and nontagged individuals was 32.4 and 32.8 mm, respectively (Table 1). After 50 days, the mean shell lengths were 35.8 and

**Table 1**  
Size of tagged and non-tagged seeds after 50 days rearing in the same tank.

	Days in culture	
	0	50
Tagged	32.4 ± 2.3	35.8 ± 2.2
Nontagged	32.8 ± 2.1	35.7 ± 2.0



**Figure 1**

Experimental procedure used to culture abalone and timetable used in assessing their growth.

35.7 mm. Thus, no difference in growth was observed after 50 days rearing in the same tank.

To examine parental effects, we compared the growth among three lots of offspring, each produced from different sets of parents. Figure 1 shows the experimental procedure. Each lot was produced by four females and three males in separate 1-ton tanks (158 × 110 × 60 cm). After 1 year of cultivation, about 40 individuals were collected from each lot, tagged, and then mixed in the same tank. Shell lengths were measured at about 50 days intervals. Seawater temperature was about 20° C, and food was supplied first by diatoms, then by *Laminaria* and *Eisenia spp.*

Figure 2 shows the growth curve (by shell length) of each lot. At day 0 the mean shell length of lots A, B, and C were nearly identical at 23.6, 23.3, and 23.8 mm, respectively. As the abalone grew, differences in shell length became large among the three lots. After 190 days from the beginning of the experiment, the mean shell length of lot B was significantly larger

than that of lot A (*t*-test,  $P < 0.05$ ). This difference indicates parental effects in cultured abalone and suggests genetic deficiencies.

In order to clarify these results, differences in growth of offsprings were estimated among three parental pairs (A, B, and C) each divided into and three different size classes (small, medium, and large). Figure 3 shows the frequency distribution of their offsprings' shell lengths. Average daily growth and the coefficient of variance for each set of offspring is shown in Table 2 by size class. In the offspring of pair A, the average daily growth of the small class was 58.6  $\mu\text{m}/\text{day}$ , that of the medium class was 82.3  $\mu\text{m}/\text{day}$ , and the growth of the large class was 111.4  $\mu\text{m}/\text{day}$ . In offspring B, the average daily growth for small, medium, and large classes were 143.0, 134.1, and 127.7  $\mu\text{m}/\text{day}$ , respectively. In the offspring of C, the small, medium, and large classes were 127.8, 120.5 and 134.6  $\mu\text{m}/\text{day}$ , respectively. Thus, daily growth means of the offspring from pairs B and C were re-

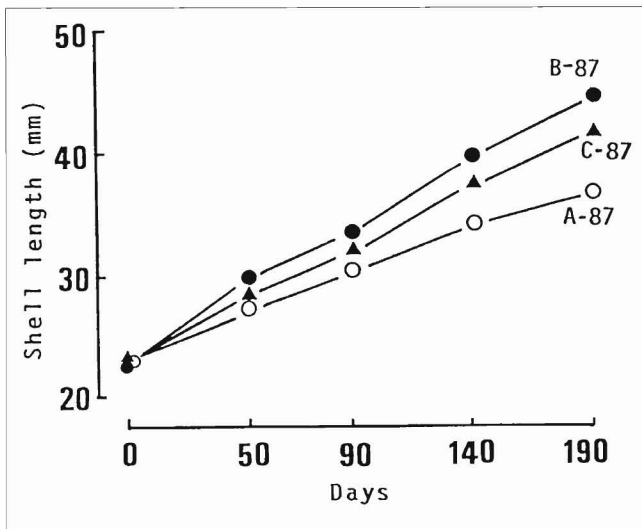


Figure 2

Growth of offspring from different parental stocks. Age of abalone at day 0 was 1 year old.

markably higher than that of the siblings from pair A in all size classes. These results support the hypothesis that there are parental effects on growth in all size classes. Differences were also noted in the daily growth among the size classes within the pair B and the pair C offspring. The coefficient of variance in the offspring of pair B ranged from 19.9 to 27.1%. The coefficient of variance in those from pair C ranged from 11.2 to 28.0%. Pair A offspring, which showed the greatest differences in daily growth means between the small and large size classes, also showed larger coefficients of variance than pair B and pair C offspring in all size classes. The small size class of the pair A offspring had the lowest daily growth and largest coefficient of variance. This observation might be caused by the existence of a large number of individuals with low growth rates. From

these results, one could surmise that the growth was related to genotypes of parents.

### Association between *Pgm-1* Allele in Isozyme and Growth

To test the association between genotypes and growth, the enzyme polymorphism of phosphoglucosyltransferase (PGM) isozyme was used. Electrophoresis was carried out using an 11% starch gel in 15.5 mM tris and 4.5mM citrate acid buffer. The electrode buffer was 0.155M tris and 0.045M citrate acid (pH 7.0). A voltage of 14.25 V/cm was applied for 6 hours at 4° C. The detection of phosphoglucosyltransferase on the gel was done by the staining procedure in Show and Prasad (1970). Figure 4 shows electrophoretic pattern of PGM isozyme in abalone, and the phenotypic variation observed. There are two loci, namely *Pgm-1* and *Pgm-2*. Appearance of *Pgm-2* is not stable; therefore, *Pgm-1* was used as the genetic marker in this study. A, B, C, and D indicate names of alleles. The B and C alleles at the *Pgm-1* locus were predominant in all the seeds from the 11 lots examined. The C allele of the *Pgm-1* locus was selected as the marker gene in the present experiment.

To test the association between genotype and growth, the C allele frequency among 11 lots was examined. After cultivation for about one year, the seeds were divided into three classes: large, medium and small. The C allele frequency at the *Pgm-1* locus was compared between the large and small classes. A higher frequency (8 lots out of 11) was observed in the large class (Table 3). If growth is controlled by the C allele at the *Pgm-1* locus, the C allele frequency would be universally high in the large class. If growth is independent of the allele at the *Pgm-1* locus, the C allele's appearance is likely to be equal in both the

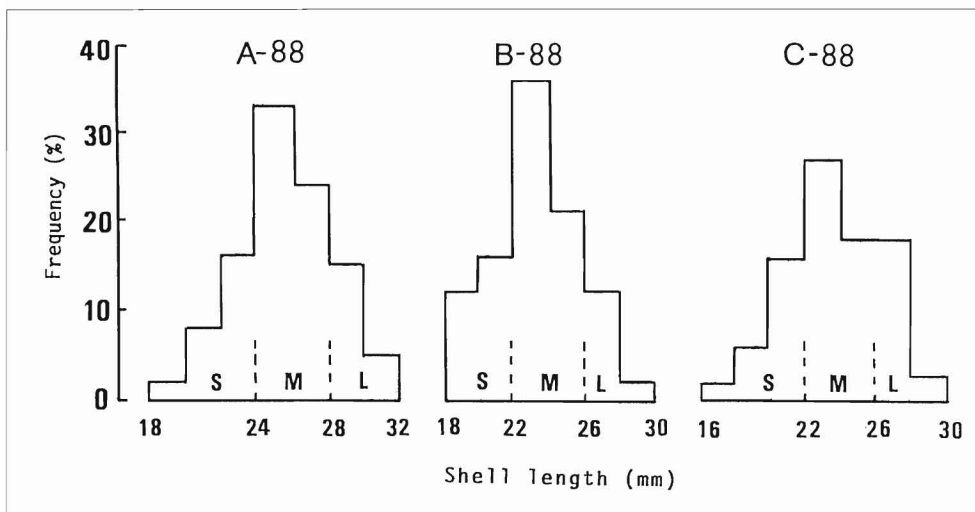
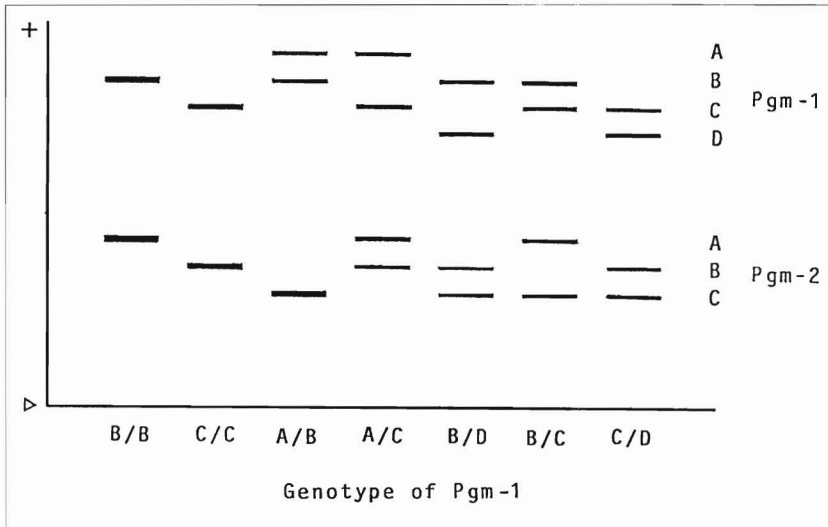


Figure 3

Frequency distribution of shell length in offspring of parental pairs A-88, B-88, and C-88. S = small size class; M = medium size class; L = large size class.

**Table 2**  
Daily growth ( $\mu\text{m}/\text{day}$ ) and coefficient of variance in three size class of offspring from three parental pairs after 190 days of laboratory culturing.

Parental pair	Offspring size class		
	Small	Medium	Large
A-88	58.6 (79.0%)	82.3 (57.1%)	111.4 (41.7%)
B-88	143.0 (19.9%)	134.1 (23.8%)	127.7 (27.1%)
C-88	127.8 (28.0%)	120.5 (30.7%)	134.6 (11.2%)



**Figure 4**  
Phenotypic variations of PGM isozyme observed in abalone.

**Table 3**  
C-allele frequencies at the *Pgm* locus of large and small classes.

Lot	Large class		Small class
A-85	0.330 (427) <sup>a</sup>	>	0.216 (162)
B-85	0.315 (62)	>	0.235 (249)
C-85	0.465 (187)	>	0.365 (230)
A-87	0.919 (301)	>	0.872 (82)
B-87	0.466 (326)	<	0.525 (100)
C-87	0.497 (301)	<	0.505 (107)
D-87	0.662 (339)	>	0.587 (104)
E-87	0.787 (338)	>	0.720 (134)
A-88	0.216 (117)	>	0.201 (67)
B-88	0.497 (149)	>	0.485 (132)
C-88	0.500 (93)	<	0.564 (110)

<sup>a</sup> Number of individuals examined.

classes. It could be tentatively concluded that the association between the *C*-allele frequency and growth is related to the linkage of the phosphoglucosmutase isozyme gene with the genes related to growth.

### Growth of Selected Abalone

The results above suggest that growth in abalone is closely related to genetic factors. If this is true, an



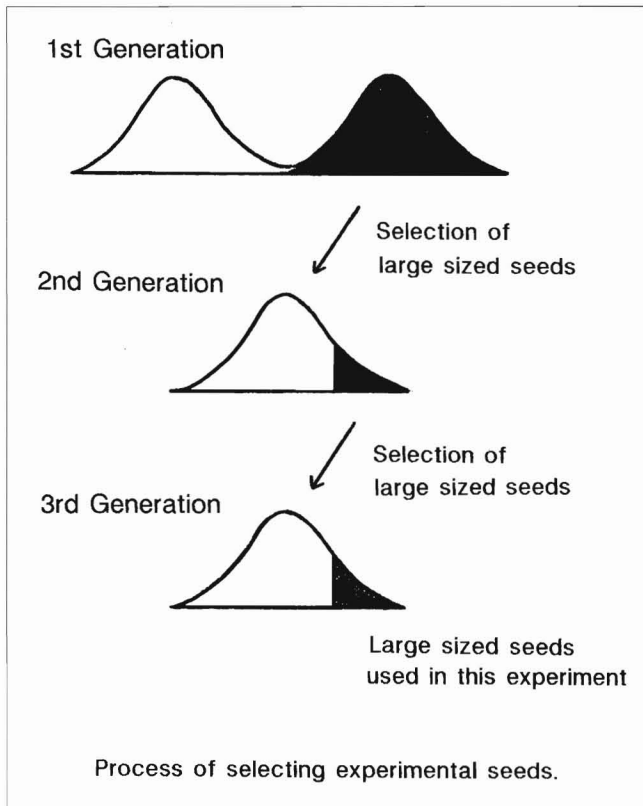


Figure 5

Process used to select abalone seeds for experimentation.

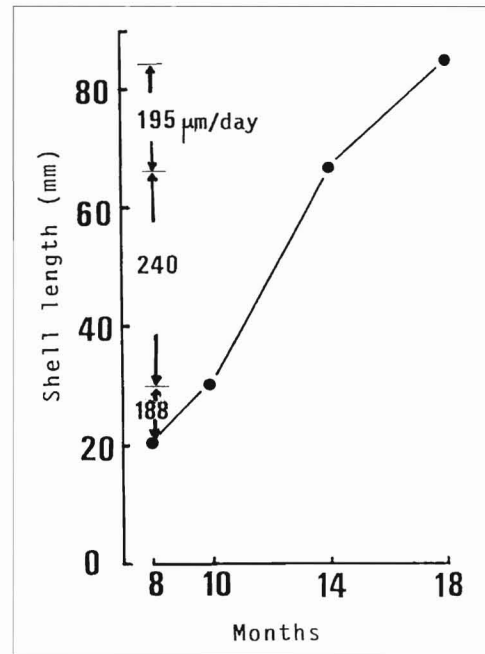


Figure 6

Growth of abalone offspring selected for superior growth rate.

Table 4

Average daily growth ( $\mu\text{m}/\text{day}$ ) of seeds from parents selected for high growth rate and commercial seeds.

Shell size (mm)	Seed <sup>a</sup>	
	Selected	Control
20-30	188	< 155
30-50	—	< 141
30-70	240	—
50-70	—	< 147
>70	195	—

<sup>a</sup> Maximum values of commercial seed growth reported in the past (Uki et al. 1981).

effect should be expected when selecting for the maximum growth rate in abalone. The effect of selection for shell length was thus tested. Figure 5 shows the process of selecting abalone for this experiment. The original lot (first generation) were large-sized seed taken from a fishermen's cooperative farming center in Japan. The first generation was grown in culture and produced offspring. The large-size class of these offspring (second generation) was grown in

culture and the large-size class offspring were similarly obtained. These offspring were also cultured for 8 months. The large-size class from this lot was used in this experiment.

The results are shown by the growth curve in Figure 6. The average shell length increased from 21 to 84 mm over a duration of 10 months (from age 8 to age 10 months). While abalone were from 20 to 30 mm in shell length, the average daily growth was 188

$\mu\text{m}/\text{day}$ . From 30 to 70 mm in size, the daily growth averaged 240  $\mu\text{m}/\text{day}$  and those over 70 mm more over grew about 195  $\mu\text{m}/\text{day}$ .

These daily growth rates were compared to those of commercial seed (Table 4). The average daily growth from 20 to 30 mm in shell length was 188  $\mu\text{m}/\text{day}$  in this experiment, while the maximum daily growth in commercial seed was less than 155  $\mu\text{m}/\text{day}$  as reported by Uki et al. (1981). The daily growth rate of the selected seed from 30 to 70 mm in size was 240  $\mu\text{m}/\text{day}$ , while commercial seed ranging from 30 to 50 mm and 50 to 70 mm in shell length grew at a rate of only 141 and 147  $\mu\text{m}/\text{day}$ , respectively. Clearly, the daily growth in the present experiment was larger than that reported in the past.

This result indicates that selective breeding is useful for improving the growth rate of cultured abalone. It is difficult to obtain stable conditions in rearing experiments. Therefore, it is necessary to repeat this or a similar rearing experiment in order to get a general conclusion.

## Acknowledgments

The authors would like to thank Y. Fujio and A. Kijima for critically reading this manuscript. This study was supported by grants to the Agriculture, Forestry, and Fisheries Research Council Secretariat.

## Citations

- Department of Statistical Information (DSI)  
1990. Fisheries Statistics of Japan. DSI, Ministry of Agriculture, Forestry, and Fisheries, Government of Japan. (In English.)
- Hara, M.  
1989. Effect of parents on growth in the abalone seeds, *Suisanikushu* 14:39-42. (In Japanese.)
- Kikuchi, S. and N. Uki  
1974. Technical study on the artificial spawning of abalone, genus *Haliotis*. Part II: effect of irradiated sea water with ultraviolet rays on inducing to spawn. *Bull. Tohoku Reg. Fish. Res.* 33:79-86.
- Takahashi, K. and A. Koganezawa.  
1988. Mass culture of *Ulvelia lens* as a feed for abalone, *Haliotis discus hannai*. In *New and innovative advances in biology/engineering with potential for use in aquaculture: proceedings of the fourteenth U.S.-Japan meeting on aquaculture* (A.K. Sparks, ed.) p. 29-36. NOAA Tech. Rep. NMFS 70.
- Uki, N.  
1989. Abalone seedling production and its theory (3). *Int. J. Aquat. Fish. Technol.* 1:224-231.
- Uki, N., J.F. Grant and S. Kikuchi  
1981. Juvenile growth of the abalone, *Haliotis discus hannai*, fed certain benthic micro algal related to temperature. *Bull. Tohoku Reg. Fish. Res. Lab.*, 43:59-64.
- Show, C.R. and R. Prasad  
1970. Starch gel electrophoresis of enzymes—a compilation of recipes. *Biochem. Genet.* 4:297-320.

# Ovarian Development in the South American White Shrimp, *Penaeus vannamei*

SUSAN M. RANKIN, JAMES Y. BRADFIELD and LARRY L. KEELEY

*Laboratories for Invertebrate Neuroendocrine Research  
Department of Entomology  
Texas A&M University  
College Station, TX 77843-2475*

## Abstract

Ovarian development is characterized in part by an accumulation of several polypeptides (protein subunits). These polypeptides become the most abundant components of the mature ovaries. Thus, the factors that regulate synthesis of these polypeptides are major factors that control egg development. In the South American white shrimp, *Penaeus vannamei*, these polypeptides are synthesized by the ovaries, presumably under the direction of one or more hormones. We are using contemporary techniques of molecular biology and peptide chemistry to identify the factors which inhibit or promote synthesis of these important reproductive polypeptides. Our characterization of these factors will lead to the development of analogs to promote reproduction under mariculture conditions. In this paper we describe ovarian maturation in shrimp and review our progress in (1) promoting an understanding of the intricate biological activities that culminate in spawning and (2) exploiting this knowledge to regulate reproduction in intact broodstock females under mariculture conditions.

## Introduction: the Problem

Achievement of the full economic potential of the shrimp mariculture industry depends on the successful domestication of the shellfish, along with genetic selection for desired traits such as rapid growth, or high tolerance for changes in temperature, salinity, or water quality. The key to domestication lies in enhanced, controlled reproduction by the broodstock animals.

To date, efforts to domesticate shrimp have been hampered, at least in many of the U.S. firms, by the practice of harvesting wild stock and promoting reproduction by eyestalk ablation (i.e., surgical removal of an eyestalk). This practice has several drawbacks: 1) continual introduction of wild stock as the basis for the next generation does not allow genetic selection and risks introduction of shrimp predators and pathogens; 2) many eyestalk-ablated animals fail to reproduce, which reduces total yield and predictability of numbers of progeny; and 3) eyestalk ablation also reduces the longevity and total fecundity of the broodstock.

Thus, a fundamental problem in the shrimp mariculture industry is the lack of predictable, abundant supplies of offspring of known heritage. The resolution of this problem lies in a multidisciplinary, multidimensional approach that involves the cooperation of physiologists, chemists, molecular biologists, and producers. We have an obligation to combine our efforts to relieve this problem by developing biotechnology and by establishing rearing conditions (appropriate temperatures, light intensities, and diets) that induce reproductive development.

Here we describe ovarian maturation in shrimp and our progress in establishing the tools necessary for identification of the hormones that affect reproduction. Furthermore, we describe our efforts in establishing the basis for bioengineering these organisms to suit the needs of mariculture. We represent several disciplines working together to solve a common problem: understanding shrimp reproduction and exploiting that understanding to improve shrimp production.

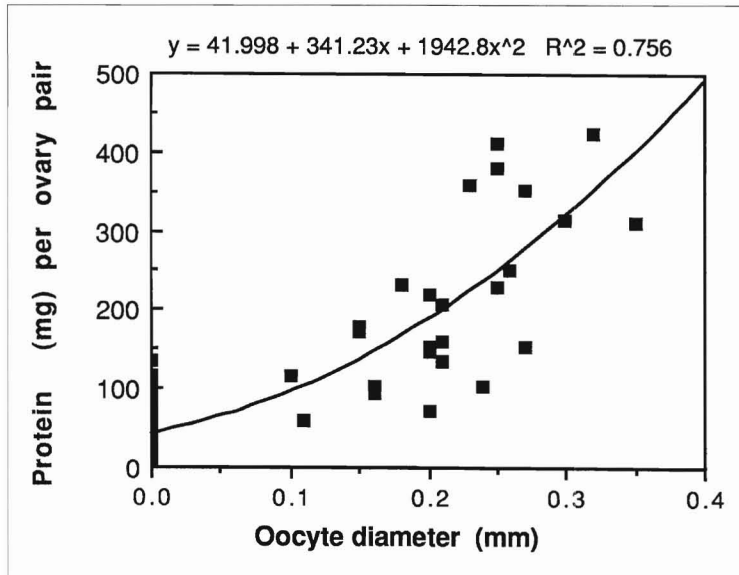


Figure 1

The total amount of protein in the ovaries as a function of oocyte diameter in *P. vannamei*. Each point represents the measurement for a pair of ovaries from a single broodstock female. (Rankin et al. 1989.) Diameters below the resolution of the dissecting microscope are graphed at "0.0".

## Morphology: Identification of the Players

**Animals.** Broodstock *Penaeus vannamei*, the species most favored for commercial mariculture in the United States, were obtained from Laguna Madre Shrimp Farm (Los Fresnos, TX) and Sea Critters (Tavernier, FL). Most of the broodstock females were 40–60 g and unilaterally eyestalk ablated to promote reproductive development (Rankin et al. 1989).

Eyestalk ablation is presumed to promote reproductive development by removing a gonad inhibiting hormone (see Charniaux-Cotton and Payen 1988). The eyestalks synthesize, store, and release a number of hormones, with one or more of these presumably suppressing reproduction. The bluish-white sinus gland is the neurohemal organ that stores and releases neurohormones in the eyestalk (Charniaux-Cotton and Payen 1988).

The mature ovary runs the length of the abdomen, surrounds the hepatopancreas, and extends into the head region (Bell and Lightner 1988). During maturation, the ovaries progress from a clear, empty appearance, to white, then usually to a creamy yellow as they near maturity. There is some variation, however, in the color of vitellogenic ovaries; they may appear greenish or orange instead of yellow.

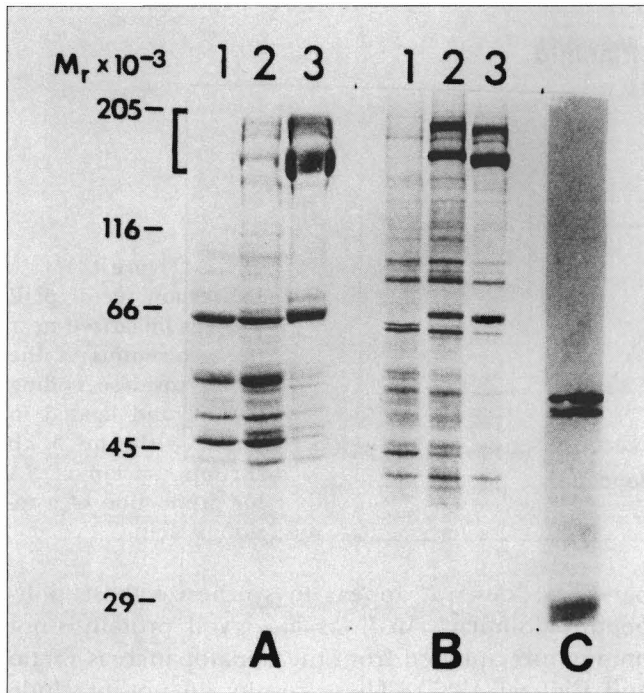
The hepatopancreas is analogous to the liver of a vertebrate, serving as a general center of intermediary metabolism and as a site for storage of reserves. Compared to the mature ovary, it is a relatively discrete and small organ, comprised interiorly of a vast number of tubules that are surrounded and held in place by the highly pigmented sheath (Bell and Lightner 1988).

## Biochemical Analysis of Ovaries

Oocyte diameter increased from below the resolution of the dissecting microscope ("0", ie., <0.01 mm) up to about 0.3 mm. Total protein in pairs of ovaries increased from < 5 mg to about 400 mg (Fig. 1; Rankin et al. 1989). The protein measurements shown in Figure 1 are the sum of a number of different kinds of proteins. Fortunately, ovarian growth is marked by the accumulation of a few specific proteins that we designate as the major ovarian proteins. Factors that regulate the synthesis of these particular proteins are therefore major elements that control ovarian development.

To identify these major ovarian proteins, we used as our initial criteria that they should be absent from previtellogenic (immature) ovaries, and become increasingly prominent, to strikingly abundant in nearly mature ovaries. We used sodium dodecyl sulfate polyacrylamide gel electrophoresis (SDS PAGE) to separate polypeptides, subunits of proteins. This approach is unorthodox in that procedures for identifying major ovarian protein usually include salt precipitation and column chromatography prior to or instead of SDS PAGE. We intentionally omitted precipitation and chromatography to avoid potential loss of major protein candidates. The potential for loss of major proteins was great in *Penaeus vannamei*, because solubility in some buffers was low (Rankin et al. 1989).

The results of SDS PAGE of ovaries in varying stages of reproductive maturity are shown in Figure 2 (Rankin et al. 1989). Ovaries in each stage had many different polypeptides. Most of the polypeptides were



**Figure 2**

SDS-PAGE of *P. vannamei* ovarian and hepatopancreatic polypeptides during the gonadotrophic cycle. (A) Coomassie blue-stained ovarian samples: Lane 1, previtellogenic ovary; lane 2, ovary at the onset of vitellogenesis; lane 3, ovary in mid to late vitellogenesis. (B) Autoradiograph of the same samples incubated with [<sup>35</sup>S]-methionine. (C) Autoradiograph of [<sup>35</sup>S]-labelled polypeptides in the culture medium after incubation of hepatopancreas from shrimp in mid-late vitellogenesis. Bracket indicates the major polypeptides (~175–200 kDa) synthesized and accumulated by ovaries during yolk formation. (Rankin et al. 1989.)

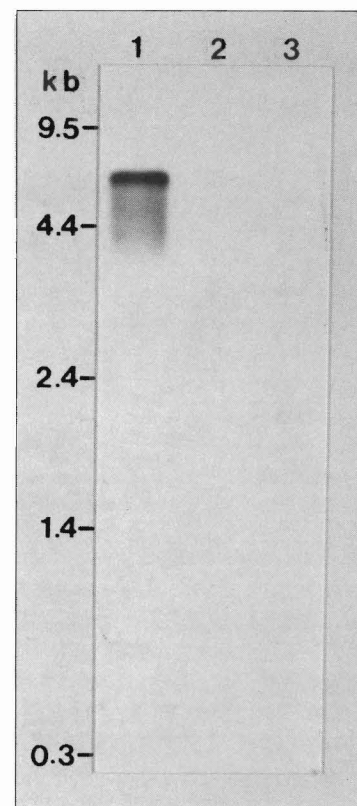
found in ovaries of each of the three stages examined. However, several polypeptides were prominent in developed ovaries and absent from immature ones. These polypeptides were 175–200 kDa, and met our criteria for major ovarian polypeptides.

The relative insolubility of the major ovarian polypeptides suggested that in *P. vannamei*, either the ovary was making the polypeptides itself, or it was modifying them after they were taken up. We investigated the origin of these polypeptides using autoradiography (Rankin et al. 1989). Tissues were incubated in a culture medium with <sup>35</sup>S-methionine, then the protein was extracted and separated by SDS-PAGE.

The autoradiographic visualization of the polypeptides synthesized by the ovary is shown in Fig. 2B. It appears that most of the polypeptides that were present in the ovary (Fig. 2A) could also be synthesized there. It clearly synthesized the high molecular

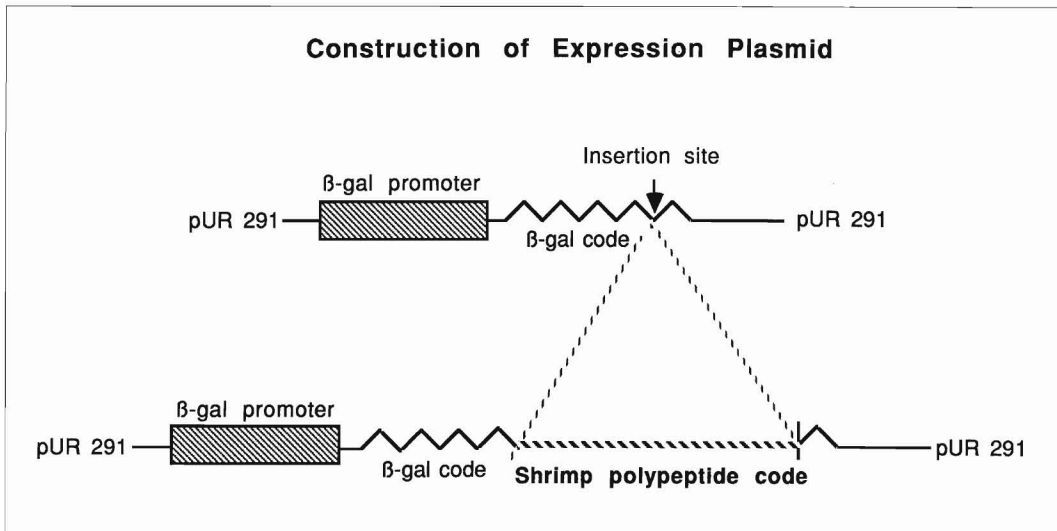
weight polypeptides that we designated the major ovarian polypeptides. Yano and Chinzei (1987) have demonstrated that the ovary of *Penaeus japonicus* is a site of synthesis of ovarian proteins, whereas Tom et al. (1987b) suggest an extraovarian source in *Parapenaeus longirostris*.

Not shown are hepatopancreas tissue samples; those appeared to lack the high molecular weight polypeptides. We also tested whether the hepatopancreas made and secreted these polypeptides for transport to the ovary by similarly incubating the hepatopancreas and then monitoring the culture medium for the presence of secreted polypeptides. Using this strategy, we could not detect synthesis of the high molecular weight polypeptides in the medium after incubation (Fig. 2C). Thus, the hepato-

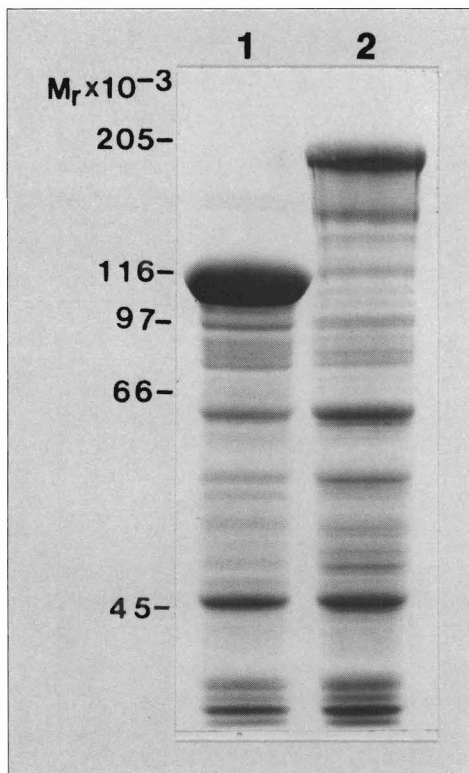


**Figure 3**

Total RNA samples (5 µg/lane) from mid-reproductive cycle *P. vannamei* tissues were denatured, separated by electrophoresis in agarose, transferred to nylon membrane, and hybridized with the cloned and labelled 3 kb ovarian cDNA. Lane 1, ovary; lane 2, hepatopancreas; lane 3, muscle. RNA size markers are indicated at left. (Bradfield et al. 1989.)



**Figure 4**  
Expression vector pUR 291 was linearized near the 3'-terminus of the  $\beta$ -galactosidase coding region, and ligated in phase with the 3 kb shrimp ovarian cDNA for production of a fusion protein.



**Figure 5**

*E. coli* JM101 was transformed with plasmid pUR 291, and plasmid-encoded  $\beta$ -galactosidase was induced by addition of isopropyl- $\beta$ -D-thiogalactopyranoside. Cell extracts were separated by SDS-PAGE (7.5%) and stained with Coomassie Blue. Lane 1, native pUR 291; lane 2, recombinant pUR 291 containing the 3 kb ovarian cDNA. The heavy band at 116 kDa in lane 1 is unfused  $\beta$ -galactosidase. The band at 205 kDa in lane 2 is a fusion consisting of  $\beta$ -galactosidase linked to a polypeptide encoded by the ovarian cDNA. (Bradfield et al. 1989.)

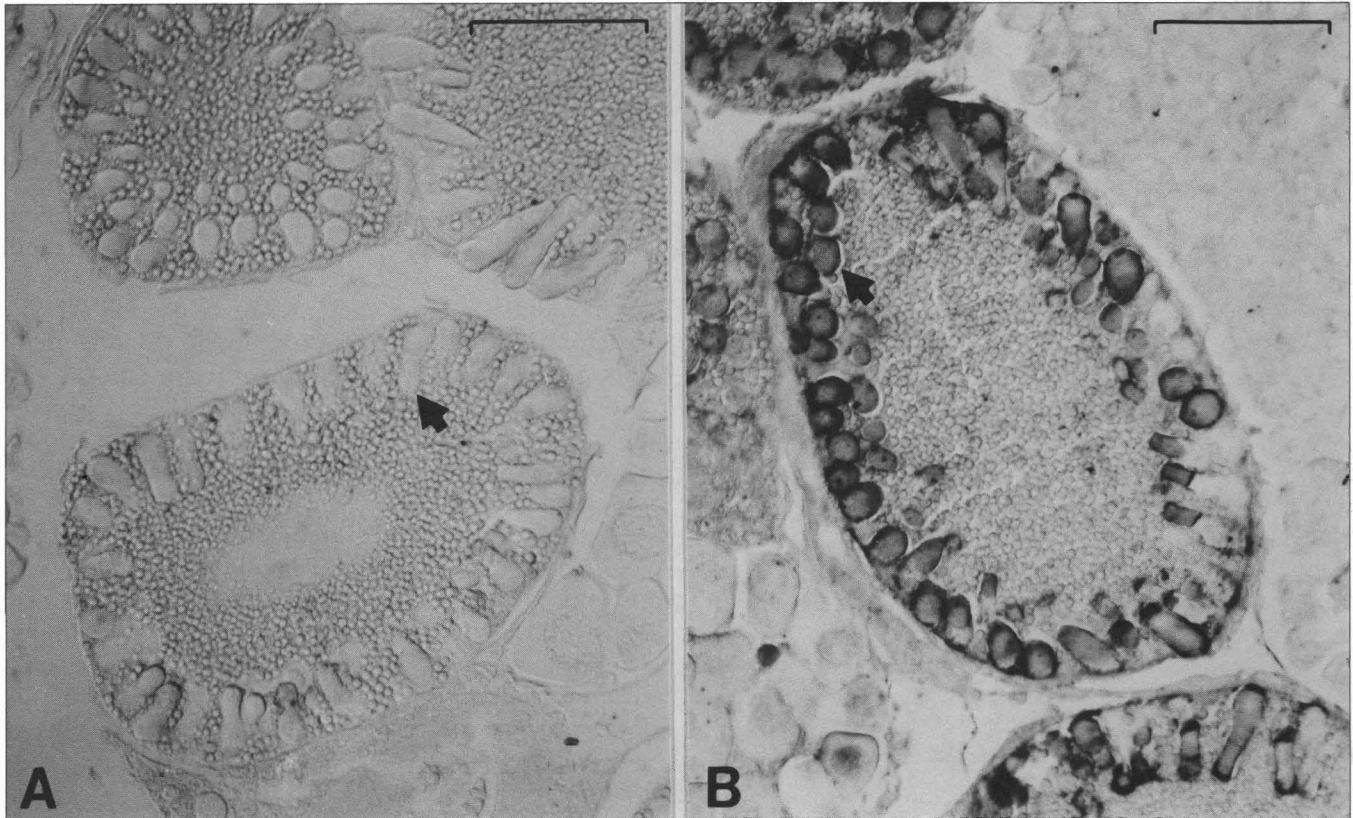
pancreas does not appear to synthesize these polypeptides. Similarly, in *P. japonicus*, yolk protein is not immunoprecipitated from the hepatopancreas (Yano and Chinzei 1987). These results do not preclude other major contributions by the hepatopancreas to ovarian development, such as lipid synthesis necessary for yolk, as has been suggested by Castille and Lawrence (1989).

### Beginning Genetic Analysis of Ovaries

The future contribution of genetic engineering to aquaculture lies in the production of genetically altered individuals with phenotypes that are well suited to aquacultural conditions. Realization of the benefits of genetic engineering depends on the generation of complementary DNA (cDNA) libraries, identification of genes and gene products, and on judicious use of molecular technology. We have begun this long process in *P. vannamei* and have used modern recombinant genetic techniques to explore the processes of ovarian development, again, with the goal of promoting the understanding and eventual manipulation of those events.

Our genetic analysis began with the construction of an ovarian cDNA library (Bradfield et al. 1989). To accomplish this, mRNA was purified from total RNA that was isolated from the ovaries. The mRNA was then used to make the cDNA library. The cDNA for one of the major ovarian polypeptides was isolated, cloned, and used as a probe to identify tissues active in synthesis of that polypeptide. This is a very sensitive assay for determining tissue sources of particular polypeptides.

The tissue source and the size of this highly expressed transcript were made visible using northern hybridization. In this procedure, RNA was extracted



**Figure 6**

Localization of the 200 kDa ovarian polypeptide using immunocytochemistry. 5  $\mu\text{m}$  ovarian sections were incubated with (Panel A) preimmune rabbit Immunoglobulin G (IgG) and (Panel B) IgG from the rabbit inoculated with the gel-purified fusion polypeptide (see Fig. 2). Immunoreaction was visualized with an alkaline phosphatase-linked second antibody. Arrows indicate cortical granules. Scale bars = 100  $\mu\text{m}$ . (Bradfield et al. 1989.)

from various tissues (muscle, hepatopancreas, and ovaries) from vitellogenic females, separated on an agarose gel, transferred to nitrocellulose (which immobilizes the RNA), then hybridized with the radioactive DNA probe representing a major ovarian mRNA in *P. vannamei*. The result was made visible by autoradiography.

Only the ovary had detectable levels of this major ovarian polypeptide RNA (Fig. 3). The size of the transcript was  $\sim 6.5$  kb. This is very large, but of course the major ovarian polypeptide is also very large. The mRNA for this polypeptide was not detected in muscle or hepatopancreas of either previtellogenic or vitellogenic females. Thus, we had confirmed by genetic analysis some of our previous results from in vitro experiments.

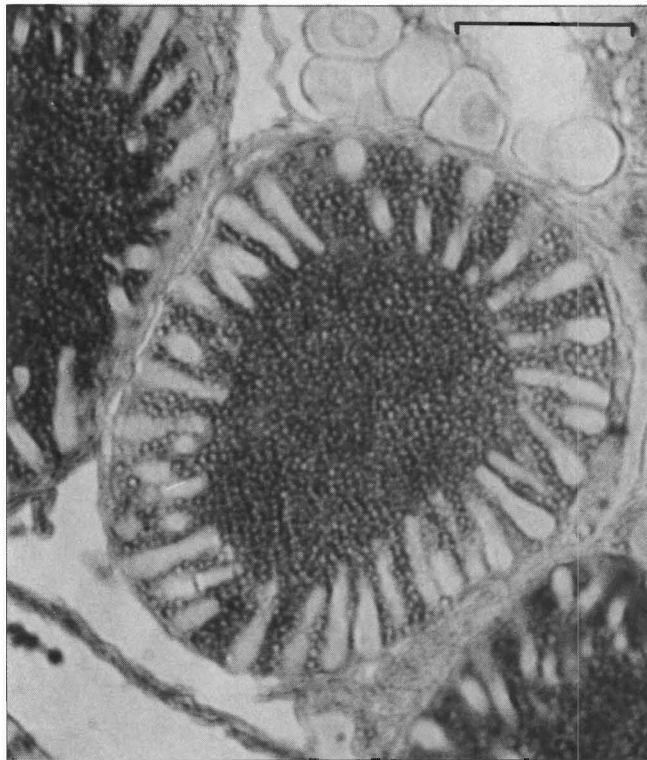
We then made a genetically engineered polypeptide consisting in part of shrimp ovarian polypeptide and in part, bacterial  $\beta$ -galactosidase ( $\beta$ -gal). To do this, the 3 kb cloned cDNA representing a portion of the 6.5 kb ovarian transcript was inserted into the plasmid pUR 291, in order to get high level expression of a fusion polypeptide consisting of plasmid-encoded  $\beta$ -gal, linked to the cDNA-encoded

product (Bradfield et al. 1989).

Figure 4 shows diagrammatically how this was done, illustrating the promoter region, the  $\beta$ -gal code and the insertion site. The recombinant plasmid was then inserted into *E. coli*. The genetically engineered fusion polypeptide was  $\sim 205$  kDa:  $\sim 115$  kDa  $\beta$ -gal and  $\sim 90$  kDa *P. vannamei* ovarian polypeptide. Figure 5 shows that fusion polypeptide as it appeared on an SDS gel. It is only by coincidence that the fusion polypeptide was about the same size as the ovarian polypeptide from which it was in part derived.

In summary, we established a cDNA expression library from shrimp ovary, and from that, isolated an ovarian polypeptide cDNA. That gene was inserted into *E. coli*, for production of the genetically engineered fusion product. The genetically engineered protein was then injected into rabbits for production of polyclonal antibodies.

Immunocytochemistry on 5  $\mu\text{m}$  paraffin sections was used to determine the cellular localization of this major ovarian polypeptide (Bradfield et al. 1989). The darkly-staining regions, which indicated immunoreactivity, were located in the cortical special-



**Figure 7**

Localization of a 175 kDa ovarian polypeptide using immunocytochemistry. 5  $\mu\text{m}$  ovarian sections were incubated with IgG from the rabbit inoculated with gel-purified ovarian polypeptide. No immunoreactivity was detected in control samples (see Fig. 6, panel A). Immunoreaction was visualized with an alkaline phosphatase-linked second antibody. Scale bars = 100  $\mu\text{m}$ .

izations (Fig. 6). Thus, the cortical specializations at the periphery of the oocyte contained the 200 kDa major ovarian polypeptide.

Cortical specializations, also called cortical rods or cortical bodies, are membrane-bound organelles that are assembled during oocyte development and become associated with the cell membrane in mature eggs. In response to one or more stimuli (such as contact with water at spawning, or fertilization), the cortical specializations are rapidly extruded to form a layer of material that encompasses the egg. In shrimp, the layer is rapidly dissipated into the surrounding seawater (Clark and Lynn 1977; Clark et al. 1980). Cortical-specialization composition, function and regulation are largely unknown. It is speculated that they prevent polyspermy or serve as an environmental protectant.

The club-shaped cortical specializations of *P. vannamei* (Figs. 6 and 7) and other shrimp (Duronslet et al. 1975; Clark and Lynn 1977; Clark et al. 1980; Anderson et al. 1984; Tom et al. 1987b; Bell and Lightner 1988; Tan-Fermin and Pudadera 1989)

are extraordinarily prominent. Because these cortical specializations are highly abundant and large, shrimp provide a beautiful model system for studying regulation of synthesis of major cellular organelles.

In contrast to the 200 kDa ovarian polypeptide, a 175 kDa polypeptide, appears to be a major component of the yolk (Fig. 7). In this case, gel-purified polypeptide, rather than genetically engineered polypeptide was used to generate polyclonal antibodies in rabbits. Yolk polypeptides serve as food for the developing embryos. This polypeptide is larger than yolk polypeptides described for other decapods (Lui and O'Connor 1977, 1976; Zagalsky 1985; Eastman-Reks and Fingerma 1985; Tom et al. 1987a). In *P. longirostris*, yolk polypeptides are 45 and 66 kDa, respectively (Tom et al. 1987a).

In summary, we have demonstrated that two major high molecular weight polypeptides in vitellogenic shrimp ovaries are immunologically distinct, and serve quite different functions for the developing embryos. We now have probes for these two major, distinct ovarian polypeptides which may or may not be regulated by the same factors. Both of these polypeptides are highly abundant and both are essential to egg development.

## Conclusions

Now that we have identified several important polypeptides that accrue in the ovary during the cycle of egg development and have demonstrated that the ovary synthesizes them, we are in a position to pursue factors that regulate the production of those important polypeptides. One goal is to identify and characterize the hormones that affect reproduction and then to determine the mechanisms by which the hormones act. We anticipate that this work, in turn, will lead to the development of stable hormone analogs which will promote controlled, predictable reproduction by intact females of known bloodlines. We have an obligation to bring people together to solve our common problem—understanding reproduction—and to exploit that understanding to help industry improve both production and profits. This requires not only physiologists, but also chemists and molecular biologists as well—all working with producers to achieve our common goal.

## Acknowledgments

This work was supported by institutional grant NA 85AA-D-SD128 to Texas A&M University by the National Oceanic and Atmospheric Administration's



Sea Grant Program, and by the Texas Advanced Technology Research Program. The research was conducted at the Texas Agricultural Experiment Station.

## Citations

- Anderson, S.L., E.S. Chang and W.H. Clark Jr.  
1984. Timing of postvitellogenic ovarian changes in the ridgeback prawn *Sicyonia ingentis* (Penaeidae) determined by ovarian biopsy. *Aquaculture* 42: 257-271.
- Bell, T.A., and D.V. Lightner.  
1988. In A handbook of normal penaeid shrimp histology. Allen Press, Lawrence, KS.
- Bradfield, J.Y., R.L. Berlin, S.M. Rankin, and L.L. Keeley.  
1989. Cloned cDNA and antibody for an ovarian cortical granule polypeptide of the shrimp, *Penaeus vannamei*. *Biol. Bull. (Woods Hole)* 177:344-349.
- Castille, F.L., and A.L. Lawrence.  
1989. Relationship between maturation and biochemical composition of the gonads and digestive glands of the shrimps *Penaeus aztecus* Ives and *Penaeus setiferus* (L.). *J. Crustacean Biol.* 9:202-211.
- Charniaux-Cotton, H., and G. Payen.  
1988. Crustacean reproduction. In *Endocrinology of selected invertebrate types*, p. 279-303. Alan R. Liss, Inc, NY.
- Clark, W.H. Jr., and J.W. Lynn.  
1977. A  $Mg^{++}$  dependent cortical reaction in the eggs of penaeid shrimp. *J. Exp. Biol.* 200:177-183.
- Clark, W.H. Jr., J.W. Lynn, A.I. Yudin, and H.O. Persyn.  
1980. Morphology of the cortical reaction in the eggs of *Penaeus aztecus*. *Biol. Bull. (Woods Hole)* 158:175-186.
- Duronslet, M.J., A.I. Yudin, R.S. Wheeler, and W.H. Clark Jr.  
1975. Light and fine structural studies of natural and artificially induced egg growth of penaeid shrimp. *Proc. Meet. World Mari. Soc.* 6:105-122.
- Eastman-Reks, S.B., and M. Fingeraman.  
1985. *In vitro* synthesis of vitellin by the ovary of the fiddler crab, *Uca pugilator*. *J. Exp. Zool.* 233:111-116.
- Liu, C.H., and O'Connor, J.D.  
1976. Biosynthesis of lipovitellin by the crustacean ovary. Part II: Characterization of and *in vitro* incorporation of amino acids into the purified subunits. *J. Exp. Zool.* 195:41-52.
1977. Biosynthesis of crustacean lipovitellin. Part III: the incorporation of labeled amino acids into the purified lipovitellin of the crab *Pachygrapsus crassipes*. *J. Exp. Zool.* 199:105-108.
- Rankin, S.M., J.Y. Bradfield, and L.L. Keeley.  
1989. Ovarian protein synthesis in the South American white shrimp, *Penaeus vannamei*, during the reproductive cycle. *Invertebr. Reprod. Dev.* 15:27-33.
- Tan-Fermin, J.D., and R.A. Pudadera.  
1989. Ovarian maturation stages of the wild giant tiger prawn, *Penaeus monodon* Fabricius. *Aquaculture* 77:229-242.
- Tom, M., M. Goren, and M. Ovadia.  
1987a. Purification and partial characterization of vitellin from the ovaries of *Parapenaeus longirostris* (Crustacea, Decapoda, Penaeidae). *Comp. Biochem. Physiol.* 87B:17-23.
- 1987b. Localization of the vitellin and its possible precursors in various organs of *Parapenaeus longirostris* (Crustacea, Decapoda, Penaeidae). *Int. J. Invertebr. Reprod. and Dev.* 12:1-12.
- Yano, I., and Y. Chinzei.  
1987. Ovary is the site of vitellogenin synthesis in kuruma prawn, *Penaeus japonicus*. *Comp. Biochem. Physiol.* 86B:213-218.
- Zagal'sky, P.F.  
1985. A study of the astaxanthin-lipovitellin, ovoverdin, isolated from the ovaries of the lobster, *Homarus gammarus* (L.). *Comp. Biochem. Physiol.* 80B:589-597.



# Changes in Hatchery Rearing and Release Strategies Resulting from Accelerated Maturation of Spring Chinook Salmon by Photoperiod Control

WALDO S. ZAUGG\*

*National Oceanic and Atmospheric Administration  
National Marine Fisheries Service  
Northwest Fisheries Center  
Coastal Zone and Estuarine Studies Division  
2725 Montlake Boulevard East, Seattle, WA 98112*

JACK E. BODLE AND JACK E. MANNING

*U. S. Fish and Wildlife Service  
Little White Salmon National Fish Hatchery  
Cook WA 98605, USA*

## Abstract

Early maturation and spawning of adult spring chinook salmon (*Oncorhynchus tshawytscha*) was induced by controlling photoperiod at the Little White Salmon National Fish Hatchery. Tagged groups of progeny from these adults were released as subyearlings in May and June, and again at their normal release time as yearlings in April of the following year. Fish released as subyearlings were recovered as adults 1) in a ratio of 1:3.5 to fish released during the same years (1984 and 1985) as yearlings; 2) at a higher ratio of males to females than yearlings; 3) with reduced numbers of precocious males (jacks) compared with yearlings; 4) predominantly as 4-year-old fish, similar to fish released as yearlings; and 5) at a larger size at the same age than adults released as yearlings. In spite of the lower return of adults from subyearling releases, this is a cost-effective method of supplementing the yearling release program and provides an excellent means of augmenting the run.

## Introduction

Historically, the abundant runs of chinook salmon (*Oncorhynchus tshawytscha*) were used as an important food source and for barter among Native Americans inhabiting the Columbia River Basin. Later, as settlers immigrated into the basin, these fish became important to commercial harvesting and recreational fishing and were soon overharvested. Presently, stocks of chinook salmon are depleted in most of the basin because of blocked and degraded habitat; artificial production in hatcheries has become essential

for the maintenance of harvestable numbers of adults. Methods used in the hatcheries to rear and release juvenile chinook salmon vary considerably, depending to some degree upon physical facilities and available water supplies of the individual hatcheries, but more importantly upon the subspecies of chinook salmon being reared.

Adult chinook salmon can be found in the Columbia River system, migrating to native waters or rearing facilities, in nearly every month of the year. There are, however, three principal groups: spring, summer, and fall chinook salmon, so designated to correspond approximately to their upstream migration and spawning times. These groups are described on the next page:

\* Present address: National Marine Fisheries Service, Cook Field Station, Cook WA 98605, USA

Salmon group	Migration time	Spawning time	Length of time in river
Spring chinook	Jan–May	Jul–Sep	4–6 months
Summer chinook	Jun–Aug	Sep–Nov	3 months
Fall chinook	Aug–Dec	Sep–Jan	1 month

Spring chinook salmon remain longer in fresh water before spawning than the other major fish groups and for much of this time exist in excellent condition. They are highly prized by recreational and commercial freshwater fishermen. However, serious problems arise when these fish move into hatchery holding ponds early in the spawning run and must be held for an extended time before spawning. Such confinement often results in high prespawning losses due to stress, physical injury, and disease. At the Little White Salmon National Fish Hatchery (Little White Salmon NFH) in Washington State, measures have been taken to reduce some of the mortality associated with long-term holding by accelerating maturation with controlled photoperiods. Early spawning not only reduces prespawning mortality but allows earlier hatching of eggs. The resulting progeny experience greater growth because of longer rearing times and manifest physiological and behavioral characteristics of developing smolts from 10 to 11 months prior to the demonstration of such characteristics in progeny from adults spawned under normal conditions.

This report provides information on releases and subsequent adult recoveries of tagged subyearling and yearling spring chinook salmon from the Little White Salmon NFH. Some preliminary information has been reported previously (Zaugg et al. 1986).

## Materials and Methods

The Little White Salmon NFH is located on the Little White Salmon River (Washington) about 2 km from its confluence with the Columbia River. Adult spring chinook salmon returning to holding ponds at the hatchery by mid-May were moved into portions of raceways covered by a metal building (9.9 × 13 m) equipped with six sodium vapor lamps (Lucalox G.E., LU 150/55) located 3.1 m above the water's surface. They were then subjected to a reduced photoperiod schedule that began with 12 hours of light per day and decreased at a rate of 30 minutes per week until spawning occurred about mid-July (Zaugg et al. 1986). After hatching, fry were reared inside in tanks containing water ranging from about 7 to 9° C. In

November they were transferred to outside ponds where water temperatures ranged from 4 to 7° C. In late March and early April 1983–85, groups of approximately 50,000 juveniles each were tagged with coded wire tags and held for release as subyearlings in either May or June of the same spring or as yearlings in April of the following year (1984–86) as indicated below (brood year in parenthesis):

Year	Tagged	Released as subyearlings	Released as yearlings
1983	+ (82)	+ (82)	—
1984	+ (83)	+ (83)	+ (82)
1985	+ (84)	+ (84)	+ (83)
1986	—	—	+ (84)

Comparisons of adult returns between groups released in the same spring (different brood years) could only be made for 1984 and 1985, as in 1983 only tagged subyearlings were released and in 1986 only tagged yearlings were released.

Fish were fed Oregon Moist Pellets (OMP) throughout the rearing period. Groups of tagged subyearlings that, for six weeks prior to release, had received OMP to which 7% NaCl (on a dry weight basis) had been added, were liberated with May releases in 1984 and 1985. Thus, three groups of subyearlings were released in each 1984 and 1985; two in May (one salt-fed) and one in June.

Information on the post-release migratory performance of subyearlings released in 1983 was obtained from captures in beach seines and mid-river purse seines at the upriver boundary of the estuary (Jones Beach, Oregon) after fish had migrated 186 km (Dawley et al. 1985; Zaugg et al. 1986). Seining operations were not conducted after the 1983 season. Information on adult recovery was obtained from a data base of the Pacific States Marine Fisheries Commission, Portland, Oregon. Weights of recovered tagged adults were estimated from lengths by comparison with a length/weight relationship determined in 1989 on a group of 72 adults held at the hatchery for antibiotic injections.

## Results

Figure 1 compares the abbreviated adult holding and juvenile rearing times that result from photoperiod treatment of adults with times for controls that undergo normal spawning and juvenile rearing. Under the accelerated spawning program, juveniles were released as subyearlings in both May and June. Progeny from the early spawn began feeding earlier and, consequently, were larger on any given date thereafter (Table 1; Zaugg et al. 1986).

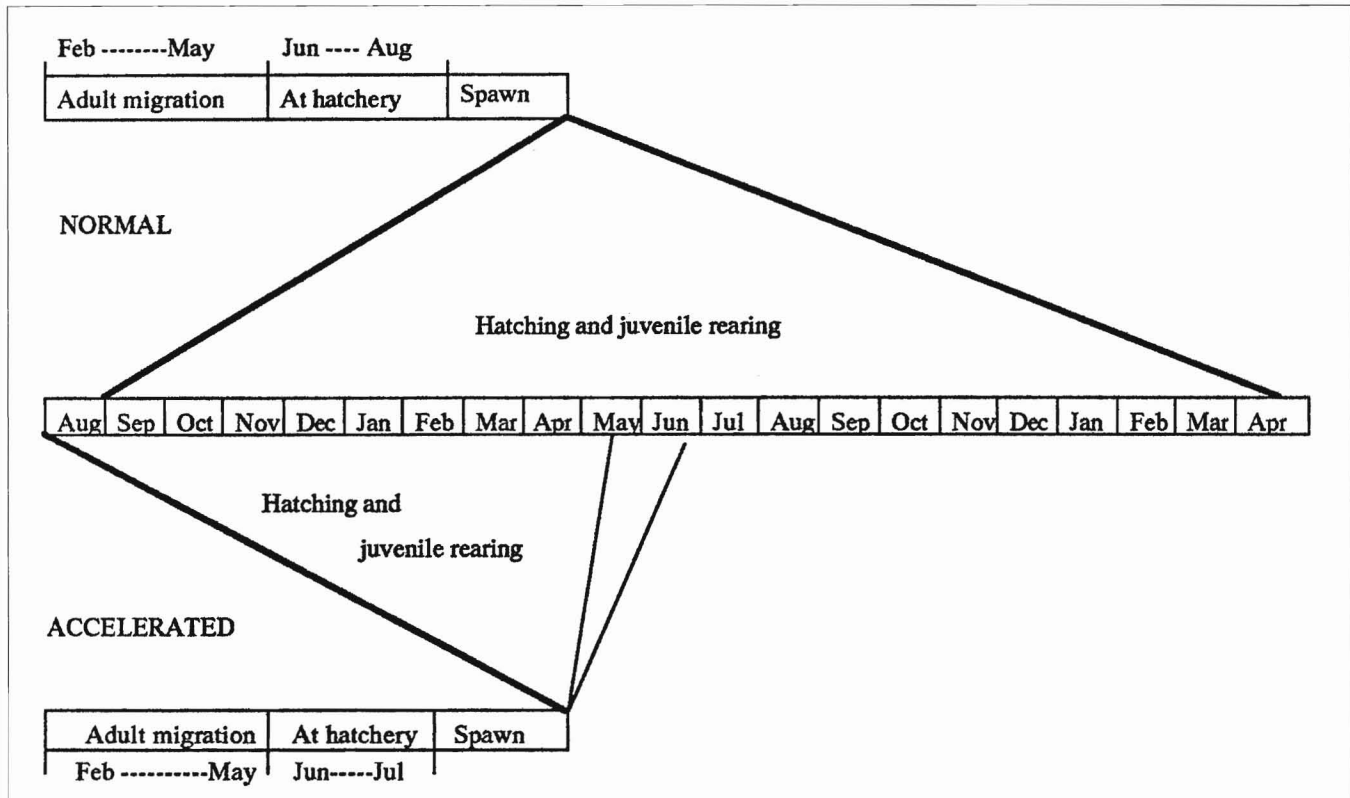


Figure 1

Comparison of spring chinook salmon adult handling and juvenile rearing between normal and advanced photoperiod schedules at the Little White Salmon National Fish Hatchery. Adults returning to this hatchery probably enter the Columbia River no earlier than February and are normally spawned in August. For release as yearlings, juveniles from normally spawned adults were reared in the hatchery until their second April. For subyearlings, juveniles from treated adults that were spawned in July were released as subyearlings the following May and June.

Table 1

Historical spawning, hatching, and fry information for spring chinook salmon from the Little White Salmon National Fish Hatchery (Zaugg et al. 1986).

Group	Spawning dates	Mean wt (g) at first feeding	Date of first feeding	Mean wt (g) on 1 October
Control (1976-79)	11-17 August	0.32	10-28 Dec	13.8
Photoperiod (1980-82)	16-22 July	0.27	29 Oct-12 Nov	24.4

Table 2

Juvenile migration of subyearling spring chinook salmon from the Little White Salmon National Fish Hatchery (1983), and adult recoveries.

Release date	Mean wt (g)	Beach seine	Number caught <sup>a</sup>		Migration rate (km/day)	Adult recovery <sup>b</sup>	
			Purse seine			Number	Percent
4 May 1983	6.7	37	7		12	14	0.03
24 June 1983	10.3	0	89		16	23	0.05

<sup>a</sup> Number caught adjusted for fishing effort (Dawley et al. 1985).

<sup>b</sup> Numbers adjusted to a release of 50,000; includes commercial and sport fishery catches and hatchery returns (source: Pacific States Marine Fisheries Commission data base).

**Table 3**

Adult recoveries from juvenile salmon released from the Little White Salmon National Fish Hatchery in 1984 and 1985.

Release year and group	Release		Adult recoveries <sup>a</sup>	
	Date	Wt (g)	Number	Percent
<b>1984</b>				
Yearling	19 Apr	36.6	109	0.22
Subyearling (salt fed <sup>b</sup> )	7 May	7.0	5	0.01
Subyearling (controls)	7 May	7.0	11	0.02
Subyearling	22 Jun	11.7	30	0.06
<b>1985</b>				
Yearlings	17 Apr	43.7	266	0.53
Subyearling (salt fed <sup>b</sup> )	6 May	7.6	104	0.21
Subyearling (controls)	6 May	7.1	101	0.20
Subyearling	20 Jun	10.5	68	0.14

<sup>a</sup> Based on 50,000 released; data includes commercial and sport fishery catches and hatchery returns (source: Pacific States Marine Fisheries Commission data base).

<sup>b</sup> Fed a diet containing an additional 7% (dry wt) NaCl for 6 weeks prior to release.

**Table 4**

Numbers of tagged female and male adult salmon returning to the Little White Salmon National Fish Hatchery from releases in 1984–85.

	Females	Males	Female/male
Yearling releases	199	89	2.24
less jacks	199	75	2.65
Subyearling releases	158	119	1.33
less jacks	158	118	1.34

During the first year of the study, juveniles released in June were larger, migrated faster, and produced more adults than those released in May (Table 2). Fish released in June were caught exclusively in the mid-river purse seine as they reached the lower river, whereas those released in May were captured primarily in the beach seine.

More adults were recovered from yearling than subyearling releases made in 1984 and 1985 (Table 3). Subyearlings released in June 1984 were recovered as adults in higher numbers than those released in May, whereas the opposite was true for subyearlings released in 1985. The overall rate of return for all groups was much higher for fish released in 1985 than for fish released in 1983 or 1984 (Tables 2 and 3).

Sex determinations on adults returning to the hatchery from tagged fish released in 1983–85 indicated a greater survival of females (Table 4). The

female to male ratio for adults returning from subyearling releases was nearer to 1:1 than the same ratio for adults returning from yearling releases. Only one precocious male (jack) was observed out of 119 males (1%) returning from subyearling releases, whereas 14 jacks out of 89 males (16%) returned from yearling releases.

Examination of the age distribution of tagged adults from both the fishery and hatchery returns showed that fish released as either subyearlings or yearlings were recovered predominantly as 4-year-olds (Table 5). Age-4 adults from subyearling releases were equivalent in size to age-5 adults returning to the hatchery from yearling releases (Table 6), both age groups having spent about 3 years in the ocean.

Table 7 presents the ratios of numbers and weights of adults recovered from yearling releases in 1984 and 1985 to those of subyearlings released in the same years. The generally lower total weight ratios

**Table 5**

Numbers of adult salmon (% of total in parentheses) taken in the fishery and returning to the Little White Salmon National Fish Hatchery, according to age in years.

Release year and group	Age			
	2	3	4	5
<b>1983</b>				
Subyearling (May)	—	—	14 (100)	—
Subyearling (June)	—	1 (4)	24 (89)	2 (7)
<b>1984</b>				
Yearling (April)	—	1 (1)	62 (63)	35 (36)
Subyearling (May, salt)	—	—	5 (100)	—
Subyearling (May, control)	—	1 (9)	10 (91)	—
Subyearling (June)	—	10 (35)	19 (65)	—
<b>1985</b>				
Yearling (April)	—	13 (5)	173 (68)	69 (27)
Subyearling (May, salt)	—	18 (18)	80 (82)	—
Subyearling (May, control)	—	19 (19)	79 (81)	—
Subyearling (June)	1 (1)	12 (18)	54 (81)	—
<b>Totals</b>				
Yearling	—	14 (4)	235 (67)	104 (29)
Subyearling	1 (0.3)	61 (17)	285 (82)	2 (0.6)

**Table 6**

Mean fork lengths in centimeters (# of fish measured) of adult salmon returning to the Little White Salmon National Fish Hatchery, according to age in years.

Release year and group	Age			
	2	3	4	5
<b>1983</b>				
Subyearling (May)	—	—	89 (11)	—
Subyearling (June)	—	66 (1)	87 (20)	101 (2)
<b>1984</b>				
Yearling (April)	—	61 (1)	76 (63)	90 (30)
Subyearling (May, salt)	—	—	92 (4)	—
Subyearling (May, control)	—	72 (1)	90 (7)	—
Subyearling (June)	—	71 (10)	88 (19)	—
<b>1985</b>				
Yearling (April)	—	56 (13)	77 (156)	89 (58)
Subyearling (May, salt)	—	73 (18)	89 (65)	—
Subyearling (May, control)	—	71 (17)	90 (61)	—
Subyearling (June)	46 (1)	73 (12)	90 (52)	—
<b>Totals</b>				
Yearling	—	56 (14)	77 (209)	89 (88)
Subyearling	46 (1)	72 (59)	89 (239)	101 (2)

(compared to the total number ratios) reflects the larger average size of recovered adults from subyearling releases (86.3 cm fork length, 7.74 kg,  $n = 348$ ) to yearling released fish (79.7 cm fork length, 5.95 kg,  $n = 348$ ).

## Discussion

Controlling photoperiod regimes to which adults are exposed is an effective way of accelerating maturation

and spawning in salmonids (MacQuarrie et al. 1978, 1979; Whitehead et al. 1978a, 1978b; Eriksson and Lundqvist 1980; Bromage et al. 1982). Johnston et al. (1990) have shown that it is possible to mature Atlantic salmon (*Salmo salar*) at nearly any time of the year by making appropriate photoperiod adjustments. At the Little White Salmon NFH, the use of advanced photoperiods on returning adult chinook salmon accelerated maturation and spawning by 4 to 5 weeks, which has resulted in the accomplishment of

**Table 7**

Ratios of numbers and estimated weights of adults recovered from yearling releases to those of adults from sub-yearling releases.

Release year and group	Number of recovered adults <sup>a</sup>	Relative number of recovered adults (yearling/subyearling)	Estimated total wt (kg) of adults <sup>b</sup>	Relative weight of recovered adults (yearling/subyearling)	Average adult wt (kg)
<b>1984</b>					
Yearling	109	—	677	—	6.2
Subyearling (May, salt)	5	21.8	48	14.1	9.6
Subyearling (May, control)	11	9.9	91	7.4	8.3
Subyearling (June)	30	3.6	198	3.4	6.6
Subyearling average	15	—	112	—	7.5
<b>1985</b>					
Yearling	266	—	1,552	—	5.8
Subyearling (May, salt)	104	2.6	796	2.0	7.7
Subyearling (May, control)	101	2.6	782	2.0	7.7
Subyearling (June)	68	3.9	532	2.9	7.8
Subyearling average	91	—	703	—	7.7
<b>Totals<sup>c</sup></b>					
Yearling (1984+1985)	375	—	2,229	—	5.9
Subyearling	106	3.5	816	2.7	7.7

<sup>a</sup> Based on release of 50,000; numbers include commercial and sport fishery catches and hatchery returns (Pacific States Marine Fisheries Commission data base).

<sup>b</sup> Weights estimated from length/weight relationships determined in 1989 from 72 returning adults.

<sup>c</sup> Averages of the three 50,000-fish release groups for each year are totaled and compared with the sum of values obtained from the two yearling release groups.

two original goals: 1) to reduce prespawning mortality by decreasing the adult holding time and 2) to produce larger yearling smolts because of a longer rearing time.

However, an unanticipated benefit resulted from the incorporation of photoperiod-accelerated spawning into the hatchery production scheme—that of smolt development in progeny during their first spring of rearing. Development of smolt-like characteristics, such as increased silver coloration, fin clarification, a dark band in caudal fins, crowding at the outlet screens, increased gill Na<sup>+</sup>-K<sup>+</sup> ATPase activities, and active seaward migration, suggested that these fish could possibly be released 10 to 11 months earlier than normal and survive to adulthood (Zaugg et al. 1986). This study was designed to test whether such early releases of subyearlings could be used to effectively augment current production and release of yearling juveniles. Adult recoveries from tagged subyearlings released in the first year of the study

(1983) were low (0.03–0.05%). However, no tagged yearlings were released that year, so a comparison of relative recoveries from the two year classes was impossible. Adult recoveries from subyearling releases made in the second year (1984) were also low (0.01–0.06%), but these could be compared to adult recoveries from yearlings released at their normal time in April of the same year (0.22%). Adult recoveries from both subyearlings and yearlings that were released in 1985 were much higher (0.14–0.21 and 0.53%, respectively).

Although numbers of recovered adults were small, it is nevertheless apparent that the release of subyearlings resulted in a ratio of adult females to males more closely approximating 1 (1.33) than did the release of yearlings (2.24). In addition, very few jacks were observed in hatchery returns from sub-yearling releases (1 of 119 returning males), whereas there were 14 jacks of 89 males that returned from yearling releases. This greater proportion of adult



males, and the lack of jacks, results in a greater opportunity to spawn individual pairs of fully matured adults, a practice presently being used to control disease.

Eighty-two percent of adults recovered from subyearling releases were age 4, whereas 67% of recoveries from yearling releases fell into this age group. This is a majority, however, for each release group. Age-4 adults from subyearling releases averaged 12 cm longer than age-4 adults from yearling releases, and were estimated to be about 1.75 kg heavier. This size differential, which was a characteristic of the adults in each age category, translated into an estimated ratio of 2.7 for the combined weight of adults recovered from yearling releases to the combined weight of adults recovered from subyearling releases made in 1984–85. The ratio of total numbers of recovered adults from these same two groups was 3.5.

Although the ratios of adults returning from yearling/subyearling releases varied considerably for the various groups released in the 2 years that comparisons could be made (1984 and 1985), the results suggest that it would be necessary to release three to four times as many subyearlings as yearlings to recover an equivalent number of adults. We estimate that three to four times as many subyearlings as yearlings could be reared in the same pond space, but for a much shorter rearing time and with lower production costs. In addition, the larger size of adults returning from subyearling releases and the reduced number of jacks makes this strategy even more economically beneficial. The release of subyearling progeny of adult spring chinook salmon matured early through the use of photoperiod control is an effective hatchery practice at the Little White Salmon NFH. A similar program might be used at other hatcheries to provide an effective method of maintaining and augmenting spring chinook salmon runs in the Columbia River Basin or elsewhere.

## Citations

- Bromage, N.R., C. Whitehead, J. Elliot, B. Broton, and A. Matty.  
1982. Investigations into the importance of daylength on the photoperiod control of reproduction in the female rainbow trout. *In* Proceedings of the international symposium on reproductive physiology of fish; 2–6 August 1982, Wageningen, The Netherlands, (C.J.J. Richter and H.J. Th. Goos, eds.), p. 233–237. Pudoc Press, Wageningen.
- Dawley, E.M., R.D. Ledgerwood, and A.L. Jensen.  
1985. Beach and purse seine sampling of juvenile salmonids in the Columbia River estuary and ocean plume, 1977–83. Vol. II: Data on marked fish recoveries, 397 p. NOAA Tech. Memo. NMFS F/NWC-75. Northwest Fisheries Center, 2725 Montlake Blvd. E., Seattle, WA 98112. NTIS PB85-187722.
- Eriksson, L.O., and H. Lundqvist.  
1980. Photoperiod entrains ripening by its differential effect in salmon. *Naturwissenschaften* 67(4):202.
- Johnston, C.E., S.R. Farmer, R.W. Gray, and M. Hambrook.  
1990. Reconditioning and reproductive responses of Atlantic salmon kelts (*Salmo salar*) to photoperiod and temperature manipulation. *Can. J. Fish. Aquat. Sci.* 47:701–710.
- MacQuarrie, D.W., J.R. Markert, and W.E. Vanstone.  
1978. Photoperiod induced off-season spawning of coho salmon (*Oncorhynchus kisutch*). *Ann. Biol. Anim. Biochim. Biophys.* 18(4):1051–1058.
- MacQuarrie, D.W., W.E. Vanstone, and J.R. Markert.  
1979. Photoperiod induced off-season spawning of pink salmon (*Oncorhynchus gorbuscha*). *Aquaculture* 18(4):289–302.
- Whitehead, C., N.R. Bromage, B. Breton, and R. Billard.  
1978a. Effects of altered photoperiod on serum gonadotropin levels and spawning in female rainbow trout. *J. Endocrinol.* 79(2):29–35.
- Whitehead, C., N.R. Bromage, J.R.M. Forster, and A.J. Matty.  
1978b. The effects of alterations in photoperiod on ovarian development and spawning time in the rainbow trout (*Salmo gairdneri*). *Ann. Biol. Anim. Biochim. Biophys.* 18(4):1035–1043.
- Zaugg, W.S., J.E. Bodle, J.E. Manning, and E. Wold.  
1986. Smolt transformation and seaward migration in 0-age progeny of adult spring chinook salmon (*Oncorhynchus tshawytscha*) matured early with photoperiod control. *Can. J. Fish. Aquat. Sci.* 43:885–888.



# Induced Spawning of Japanese Eel with LHRH-A Copolymer Pellet

KEIJI HIROSE

National Research Institute of Aquaculture  
Nansei  
Mie 516-01, Japan

## Abstract

A new hormone therapy was tested for inducing maturation and ovulation in the Japanese eel *Anguilla japonica*. A luteinizing hormone-releasing hormone analogue (LHRH-A) copolymer pellet, which shows a slow and constant release of hormone over 75 days, was used in this study. The fish were treated with eight weekly injections of salmon pituitary and human chorionic gonadotropin (HCG), after which time the LHRH-A pellets were implanted in the fish. Final maturation and ovulation was induced in the mature fish at 15–29 weeks by injection with 17 $\alpha$ -hydroxyprogesterone (17 $\alpha$ -OHprog) and HCG; the treated fish spawned naturally for 2 days. This hormone treatment schedule could induce a high success of spawning because it eliminates the stresses incurred by repeated injections of hormones. The best result was obtained in fish kept at a low water temperature of 15° C.

## Introduction

Recently, eel consumption has increased, reaching 70 thousand metric tons (t) per year in Japan. However, the production of eel elvers in natural waters has been decreasing for the past 20 years (Statistics and Information Department, Ministry of Agriculture, Forestry, and Fisheries 1990). Presently, there is a shortage of seed which is barely covered by imports. The development of artificially induced breeding techniques of eel have long been needed in Japan. Thus, the controlled reproduction of the Japanese eel *Anguilla japonica* has been attempted for a long time. Ten to fifteen years ago, several research groups succeeded in inducing spawning of the eel by treatment with fish pituitary (Yamamoto et al. 1976; Motonobu et al. 1976; Satoh 1979). Since then, there have been almost no excellent results on the induced spawning of eels. In those previous experiments, the spawning rate is very low, 5–10%. Final maturation and ovulation are not well controlled and the larvae do not survive over 10–15 days. In general, catadromous type eels (silver eel *A. japonica*) are most widely used for induced spawning. The initial state of their ovaries is immature just before or shortly after initiation of yolk formation. If we wish to induce ovarian maturation and spawning in immature eels, a relatively long-term hormone therapy is necessary.

However, repeated administration of exogenous hormones results in gonadal atresia, which may be caused by stress and the production of an undesirable antibody. The repeated treatments of exogenous hormones may be related to the failure to induce ovulation, low spawning rates, and also problems in egg quality. To avoid stress and undesirable results from the repeated treatments, we developed a copolymer pellet containing luteinizing hormone-releasing hormone analogue (LHRH-A), which provides a slow and constant release of hormone over a long period of time and which succeeded in inducing final maturation and ovulation when implanted in ayu (*Plecoglossus altivelis*) (Yoshida et al. 1986; Hirose et al. 1990). In this study, the author tested the potency of this pellet for inducing maturation and spawning in Japanese eels.

## Materials and Methods

The cultured eels used for this study were over 10 years old and were raised at the Inland station of the National Research Institute of Aquaculture. Before beginning the experiments, fish were transferred to the main station of the institute and held in a 1-t flow-through seawater aquarium with temperature constant at 15 or 20° C.

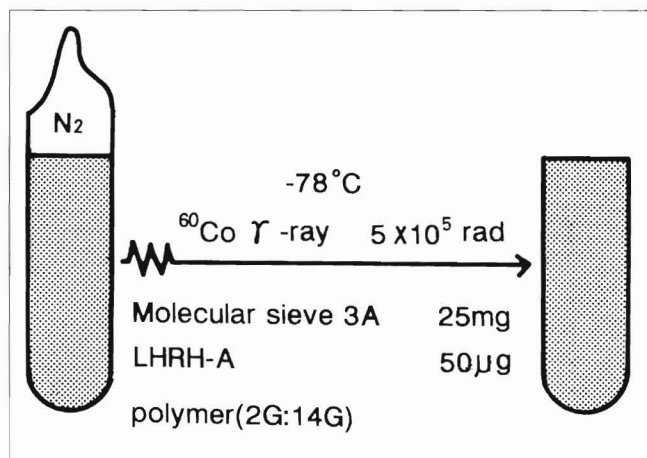


Figure 1

Schematic diagram for preparation of LHRH-A copolymer pellet using the methods of Yoshida et al. 1986. Luteinizing hormone-releasing hormone analog (LHRH-A, 50 µg) dissolved in phosphate buffer was absorbed to 25 mg of molecular sieve 3A. Following evaporation, molecular sieve 3A containing hormone was charged into a glass ampoule. A hydrophobic diethylene glycol dimethacrylate (2G) and hydrophilic polyethylene glycol #600 dimethacrylate (14G) monomer mixture was also charged into the ampoule. The ampoule was sealed off under nitrogen gas and irradiated with gamma-rays from a  $^{60}\text{Co}$  source at  $5 \times 10^5$  rad/hr, at  $-78^\circ\text{C}$ . The co-monomer in the supercooled state was completely polymerized by the irradiation. The product was then removed from the ampoule mold.

## Hormones

Luteinizing hormone-releasing hormone analogue, des Gly<sup>10</sup>-[D-Ala<sup>6</sup>] LHRH ethylamide (Sigma), human chorionic gonadotropin, (HCG, Teikoku Hormone MGF. Co. LTD., Tokyo) and chum salmon *Oncorhynchus keta* pituitary (caught in Iwate Prefecture) were used. The schema for the preparation of a dry-copolymer composite in rod form (1.6 mm in diameter and 10 mm long) is shown in Figure 1. Detailed preparation methods of the copolymer pellet by radiation-induced polymerization are described by Yoshida et al. (1986). In vitro experiments showed that the copolymer pellet released LHRH at a relatively constant rate over 75 days (Hirose et al. 1990). In this study, a copolymer pellet containing 50 µg LHRH-A was used. The pellet was implanted intramuscularly. Chum salmon pituitary and HCG were also given weekly to induce maturation and spawning of the eels.

## Treatment Schedules

Two experiments involving the following three treatment schedules were undertaken (see Fig. 2).

**Treatment schedule A**—Weekly treatment with chum salmon pituitary (30 mg/fish) and HCG (300 IU/fish) for the first 8 weeks. Only chum salmon pituitary was administered thereafter until ovulation was induced artificially.

**Treatment schedule B**—Weekly treatment with chum salmon pituitary (30 mg/fish) and HCG (300 IU/fish) for 8 weeks followed by implantation of the LHRH-A polymer pellet. The fish were not treated with pituitary and HCG after implantation of the pellet until ovulation was induced.

**Treatment schedule C**—Weekly treatment with chum salmon pituitary (30 mg/fish) and HCG (300 IU/fish) for 8 weeks followed by chronic treatment with the LHRH-A polymer pellet, which was implanted in the 8th week. Chum salmon pituitary was administered at a level of 30 mg/fish for the first 8 weeks; 20 mg/fish thereafter. No HCG was given after 8 weeks until ovulation was induced.

Both experiments were conducted in the 1-t tank using groups of three female fish per treatment. Experiment I was held at  $20^\circ\text{C}$  and involved treatments A and B only. Experiment II was held at  $15^\circ\text{C}$  and involved treatments A, B, and C.

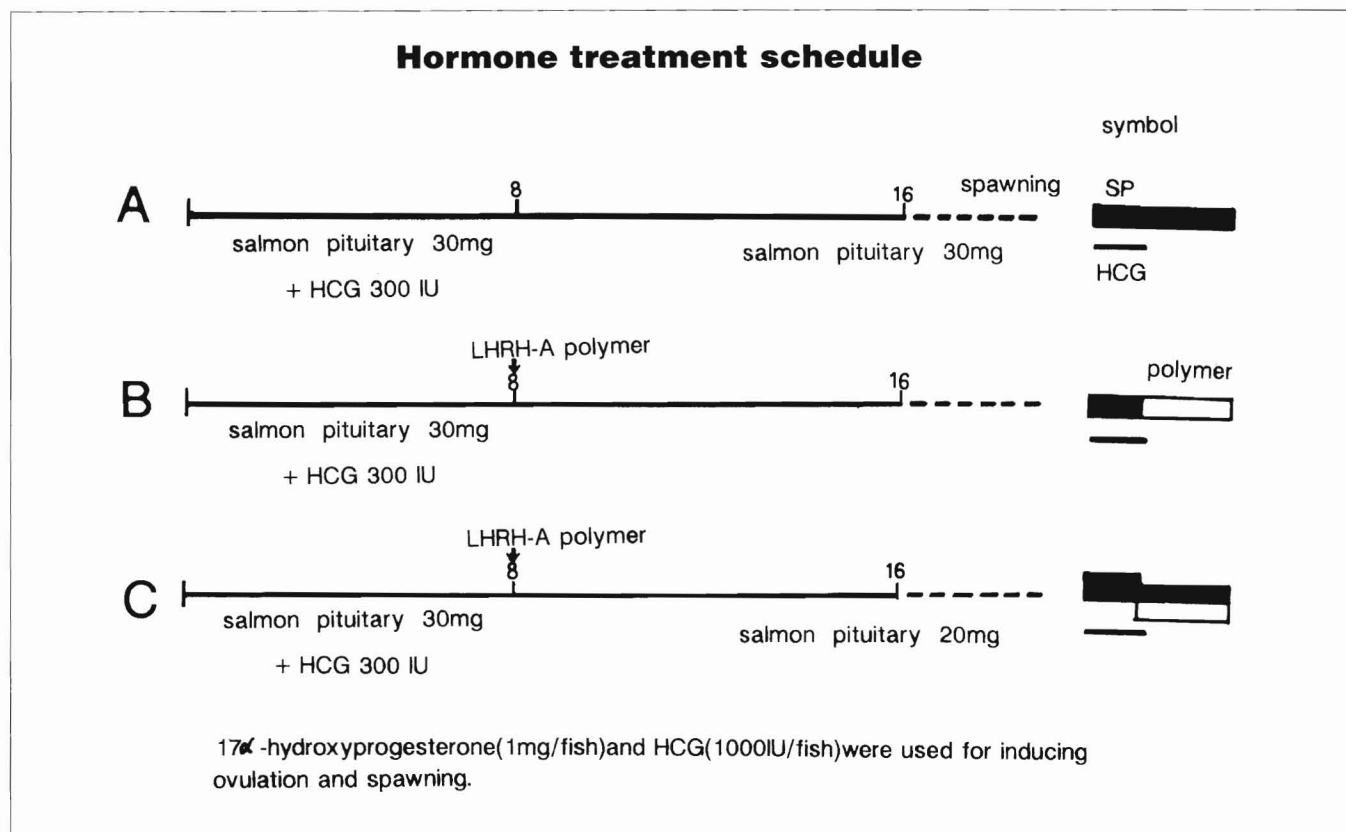
Body weight was measured weekly and changed little until final maturation was induced. A somewhat rapid increase in body weight occurs during final maturation and ovulation due to hydration of oocytes. Therefore,  $17\alpha$ -hydroxyprogesterone ( $17\alpha$ -OHprog 1 mg/fish) and HCG (1000 IU/fish) were administered to the mature eel when it showed a slight increase in body weight just prior to the rapid increase in body weight. Ovulation and spawning were induced within 2-3 days following the treatment with  $17\alpha$ -OHprog and HCG. For males, six or seven weekly injections with HCG (300 IU/fish) were enough to induce spermiation.

## Results and Discussion

At the initiation of the experiments the cultured eels had not yet attained the primary yolk globule stage and their gonadal somatic indexes were below 2.0. After eight weekly injections of chum salmon pituitary and HCG, the fish ovaries had oocytes in the primary yolk globule stage. At this time, LHRH-A polymer pellet was implanted to the eel.

### Experiment I

In the treatment schedule A group (Table 1), one (D-3) of three fish spawned after 15 of the weekly

**Figure 2**

Hormone treatment schedules for inducing maturation and spawning in Japanese eel in Experiments I and II. Experiment I was held at 20° C and involved treatments A and B only. Experiment II was held at 15° C and involved treatments A, B, and C. HCG = Human chorionic gonadotropin; SP = Chum salmon pituitary. Time on line marked in weeks. 17 $\alpha$ -hydroxyprogesterone (1 mg/fish) and HCG (1000 IU/fish) were used to induce ovulation and spawning.

**Table 1**

Experimental results from experiment I which was performed at 20° C. See text for descriptions of treatment schedules.

Fish no.	Body weight (g)	% increase of body weight	Gonadal somatic index	Time of injection (weeks)	Remarks
<b>Treatment schedule A</b>					
D-1	606	8.7	33.4	16	over-mature
2	627	30.5	35.2	16	over-mature
3	656	— <sup>a</sup>	19.7+	15	spawned, unfertilized
<b>Treatment schedule B</b>					
E-1	545	0	19.7	20	dead, final maturation
2	561	24.5	—	16	spawned, larvae survived 7 days
3	633	26.3	—	20	spawned, larvae survived 7 days

<sup>a</sup> — = data not collected.

**Table 2**

Experimental results from experiment II, which was performed at 15° C. See text for description of treatment schedules.

Fish no.	Body weight (g)	% increase of body weight	Gonadal somatic index	Time of injection (weeks)	Remarks
<b>Treatment schedule A</b>					
F-1	691	13.2	42.3	16	dead, final maturation
2	1019	30.0	— <sup>a</sup>	26	over-mature
3	1713	-7.5	20.5	31	yolf deposition
<b>Treatment schedule B</b>					
G-1	1492	13.3	37.8	24	ovulated, artificial fertilization
2	988	33.3	—	29	spawned, larvae survived 8 days
3	1250	12.9	—	27	spawned, larvae survived 12 days
<b>Treatment schedule C</b>					
H-1	1600	12.8	25.5	22	dead, mature
2	1400	11.4	34.5	18	dead, larvae
3	1579	16.0	—	27	spawned, larvae survived 8 days

<sup>a</sup> — = data not collected.

injections, although the eggs were not fertilized. The others quickly developed to an overly-mature state and could not spawn. In the treatment schedule B group, two (E-2 and 3) of three fish spawned naturally and the resulting larvae survived for 1 week. Female fish developed to a mature or spawning state after 16–20 weeks of injections.

## Experiment II

In the treatment C group (Table 2), one fish (H-3) spawned at 27 weeks, while the other fish died when they became completely mature. In the schedule B group, two of the three fish spawned naturally; the other one ovulated earlier at 24 weeks at which time artificial fertilization was performed. Some of the schedule B larvae survived for 8–12 days but they could not ingest any live organisms (rotifers or fertilized oyster eggs). Treatment schedule A fish could not spawn. The lower temperature used for experiment II (15° C) lengthened the duration of the weekly injections to 24–29 weeks.

Based on the results from two experiments, treatment schedule B performed at 15° C is the best method for inducing maturation in the Japanese eel.

A combination of 17 $\alpha$ -OHprog and HCG was given to the mature fish to induce final maturation and ovulation and, thereafter, they were expected to spawn naturally within 48 hours. The processes of final maturation and ovulation proceeded very quickly at a water temperature of 20° C. At that temperature the fish showed a very rapid increase in body weight and high gonadal somatic index, changing into an overly mature state.

Figure 3 shows the frequency of egg diameter from mature eels kept at 20° C (treatment schedule C in a preliminary experiment). The most developed oocytes, which were in the migratory nucleus stage and contained many small oil droplets, were 0.7–0.8 mm in diameter. Following ovulation, the oocytes quickly changed into an overly mature state, as seen by the presence of eggs that now contained only a few large oil droplets and were not fertilized (Hirose, unpubli. data). Moreover, ovulation was not always preceded by final oocyte maturation when the mature fish were kept in water temperatures over 20° C. Thus, high temperature conditions may cause the production of poor quality eggs in a very short time. Mature fish should therefore be kept in somewhat cool water (15° C). If gravid eels are cultured under the lower temperature condition, body weight does not in-

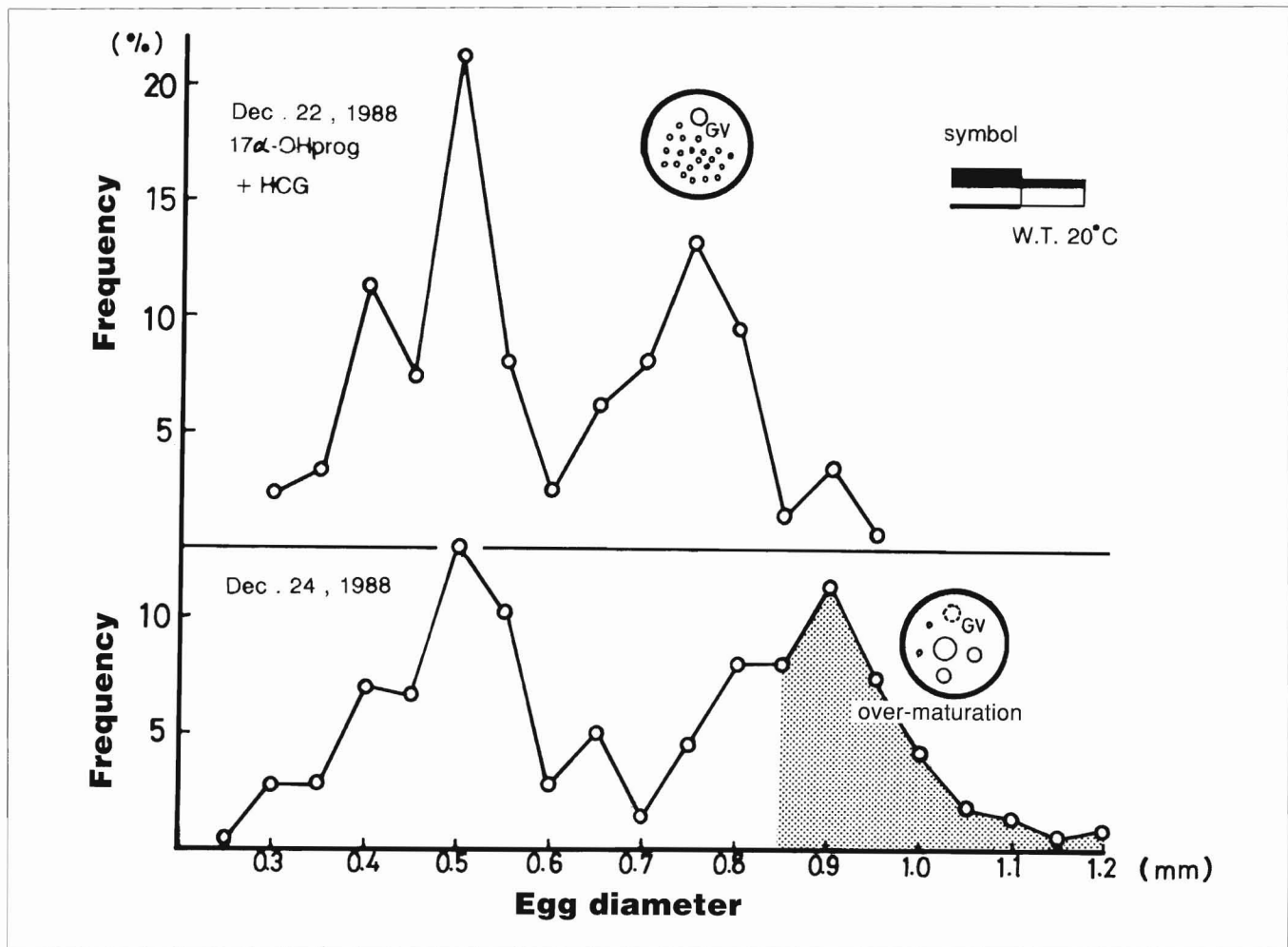


Figure 3

Frequency distribution of oocytes in the mature eel treated with 17 $\alpha$ -hydroxyprogesterone (17 $\alpha$ -OHprog) and HCG at 20°C. (Hirose, unpubl. data). Fish were observed to mature using treatment schedule C in a preliminary experiment. Oocyte samples were obtained using a polyethylene cannula inserted into the urogenital pores of the eels. Thereafter, the oocytes were observed under a microscope. The mature oocytes (0.7–0.8 mm in diameter) had germinal vesicles (GV) and many small oil droplets. After hormone treatment, the oocytes rapidly changed into an overly mature state (shaded portion) in 2 days; germinal vesicle breakdown (dotted circle) and a few large oil droplets were also present—a typical feature in overly mature eggs.

crease as rapidly during final maturation, as shown in previous reports (Sugimoto et al. 1976; Yamauchi and Yamamoto 1982). Consequently, a final injection of HCG and 17 $\alpha$ -OHprog for inducing ovulation is timely when given to mature fish, and a high frequency of natural spawning can be anticipated.

In general, it is said that the stress of handling during hormone injection decreases the efficiency of hormone treatment and may cause rapid atresia of the gonads (Hirose 1980; Billard et al. 1981). This LHRH-A polymer pellet has a long hormone delivery time and is especially useful for inducing maturation in fish requiring a series of hormone treatments over a long time period. The ability to induce a high percentage of treated eels to spawn is of great impor-

tance. In this study, a high frequency of maturation and spawning was induced using hormone treatment schedule B in experiment II (15°C) followed by an injection of 17 $\alpha$ -OHprog and HCG. If we can increase the spawning frequency in the hormone-treated fish, the artificial propagation of eels will be achieved in the future.

#### Acknowledgment

I am deeply grateful to Dr. M. Yoshida of Japan Atomic Energy Research Institute for kindly supplying the LHRH-A copolymer pellet.

## Citations

- Billard, R., C. Bry, and C. Billet.  
1981. Stress, environment, and reproduction in teleost fish. (A.D. Pickering, ed.), p.185-208. Acad. Press, NY.
- Hirose, K.  
1980. Effects of repeated injections of human chorionic gonadotropin (HCG) on ovulation and egg qualities in the ayu, *Plecoglossus altivelis*. Nippon Suisan Gakkaishi 46:813-818.
- Hirose, K., H. Kagawa, M. Yoshida, M. Kumakura, and H. Yamanaka.  
1990. Application of LHRH copolymer pellet for induction of final oocyte maturation and ovulation in ayu *Plecoglossus altivelis*. Nippon Suisan Gakkaishi 56:1731-1734.
- Motonobu, T., K. Yamashita, and H. Oka.  
1976. Memoir on the hatched larva of the Japanese eel, *Anguilla japonica*, from the adults matured artificially. Bull. Shizuoka Pref. Fish. Exp. Station 10:87-90. (In Japanese.)
- Satoh, H.  
1979. Towards the complete cultivation of Japanese eel. Iden (Genetics) 33:23-30 (in Japanese).
- Statistics and Information Department, Ministry of Agriculture, Forestry, and Fisheries.  
1990. Gyogyo-yoshokugyo-seisan-toukei-nenpou. Tentative English title: Fisheries statistics of Japan, p.181 and 268. (In Japanese.)
- Sugimoto, Y., Y. Takeuchi, K. Yamauchi, and H. Takahashi.  
1976. Induced maturation of female Japanese eels (*Anguilla japonica*) by administration of salmon pituitaries, with notes on changes of oil droplets in eggs of matured eels. Bull. Fac. Fish. Hokkaido Univ. 27:107-120.
- Yamamoto, K., M. Nakamura, H. Takahashi, and K. Takano.  
1976. Cultivation of larvae of Japanese eel. Nature 263:412.
- Yamauchi, K. and K. Yamamoto.  
1982. Experiments on artificial maturation and fertilization of the Japanese eel (*Anguilla japonica*). In Proceedings of the international symposium on reproductive physiology of fish (C.J.J. Richter and H.J. T. Goos, eds.), p. 185-189. Center for Agricultural Publishing and Documentation, Wageningen, the Netherlands.
- Yoshida, M., M. Asano, I. Kaetu, K. Imai, H. Yuasa, H. Nakayama, K. Shida, K. Suzuki, K. Wakabayashi, and I. Yamazaki.  
1986. Pharmacological response in male rats with controlled release formulations of luteinizing hormone-releasing hormone agonist. Polymer Jour. 18:287-296.



# Reproductive Physiology of Sablefish (*Anoplopoma fimbria*) with Particular Reference to Induced Spawning

IGOR I. SOLAR, EDWARD M. DONALDSON, IAN J. BAKER,  
HELEN M. DYE, ALEXANDRA VON DER MEDEN, and JACK SMITH

*Department of Fisheries and Oceans  
Biological Sciences Branch  
West Vancouver Laboratory  
4160 Marine Drive  
West Vancouver, B.C. V7V 1N6 Canada*

## Abstract

This paper summarizes information on the reproductive physiology of sablefish (*Anoplopoma fimbria*) obtained during five years of studies on the induced ovulation of captive female sablefish. The ability to induce ovulation and spawning in captive broodstock is considered critical for the development, expansion, and diversification of aquacultural operations on the Pacific coast of Canada into indigenous marine species. Results are discussed on the use of partially purified salmon gonadotropin and several mammalian luteinizing-hormone releasing hormone analogues (LHRHa); the ovarian hydration response; the effect of administering LHRHa by different routes on plasma estradiol levels; and the use of a dopamine antagonist. Other preliminary and unpublished data are also presented.

## Introduction

Sablefish (*Anoplopoma fimbria*), also known as blackcod (Fig. 1), range along the North American coast from the northeastern Bering Sea to Baja California. Its depth distribution ranges from the continental shelf to about 1500 m (McFarlane and Beamish 1983). Spawning, which takes place at depths of 300–700 m, lasts from January to March and peaks in February (Mason et al. 1983, Fujiwara and Hankin 1988).

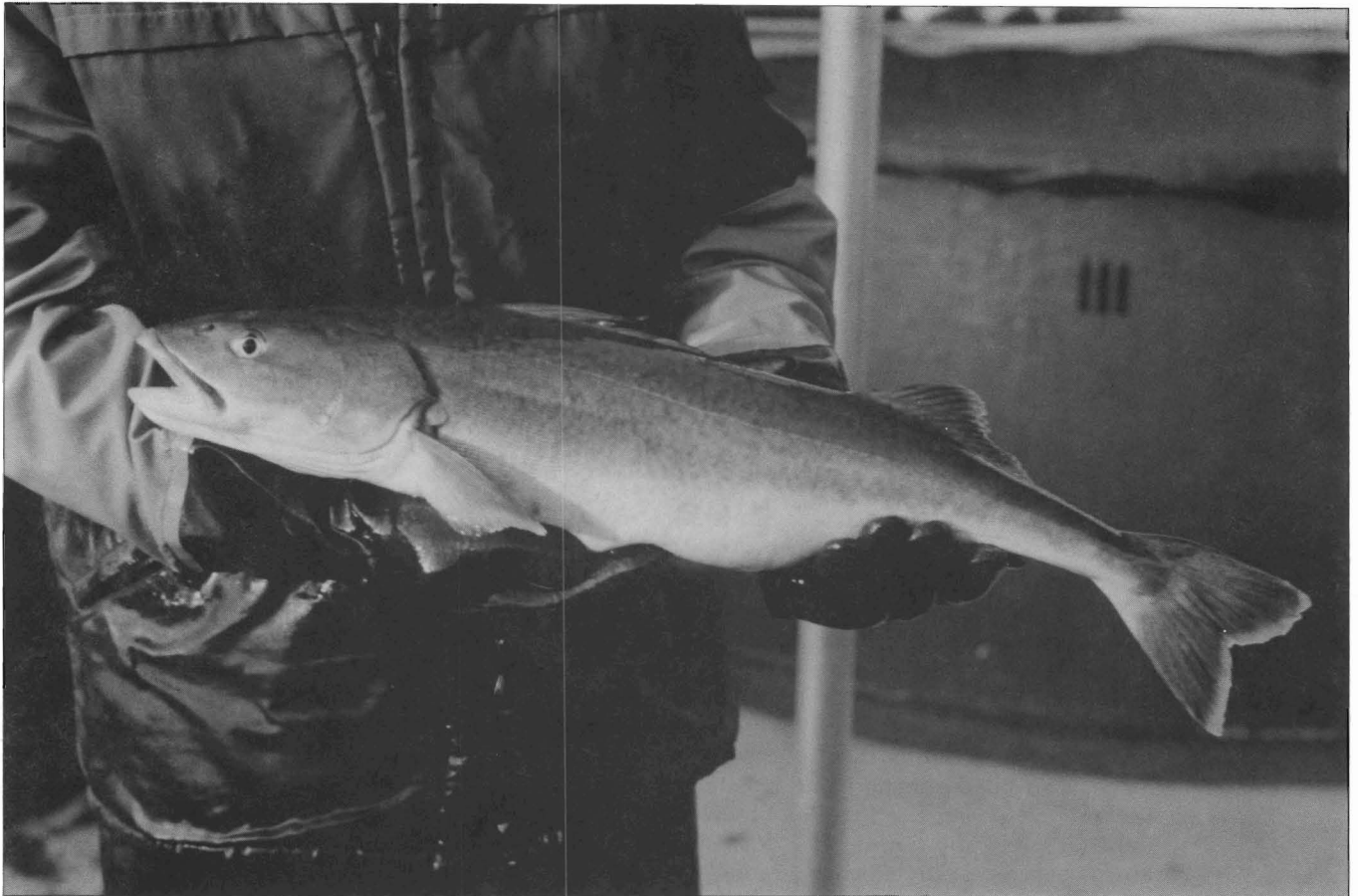
The sablefish is considered a prime candidate for commercial aquaculture because of its adaptability to confinement and its indiscriminate feeding behavior. The development of methods for spawning sablefish in captivity and for rearing the larvae are expected to facilitate the future establishment of mariculture operations for this species on the west coast of Canada. Early studies on the culture of sablefish were dependent on the impoundment of wild juveniles, and studies of larval rearing have relied upon the capture of wild maturing broodstock and the stripping of their gametes at sea (McFarlane and Nagata 1988). Neither of these practices would be feasible or desirable as a basis for commercial culture.

The Pacific Biological Station (PBS), Nanaimo, B.C., initiated studies on sablefish mariculture in the early 1970's (Kennedy 1972). These studies have continued using a multidisciplinary approach both at the PBS and at the West Vancouver Laboratory since 1985. The present review summarizes our findings to date in the area of induced spawning.

## Maturation of Captive Fish

Sablefish do not usually undergo final maturation in captivity. Since 1985, only 1 of over 150 females ripened spontaneously (fish in stock group, without treatment) at the Pacific Biological Station. Although sablefish are known to be yearly spawners in the wild, only one individual maintained in captivity from one spawning season to the next responded to hormone therapy a second time. The inability of females to undergo ovarian maturation in captivity has been attributed to environmental and nutritional factors. Males, on the other hand, frequently mature and spermiate without endocrine treatment.

Hormonal treatments applied to maturing captive fish in our laboratories from 1985 to 1989 resulted in



**Figure 1**  
Adult female sablefish, *Anoplopoma fimbria*.

an ovulatory response in 59.4% of the experimental animals while no fish in the control groups ovulated.

### **Hormonal treatments**

Several compounds have been assayed for their ability to induce spawning in sablefish. Our study conducted in 1985 (Solar et al. 1987) demonstrated for the first time the feasibility of inducing ovarian hydration and ovulation in sablefish (65% ovulation response). In this first study, we utilized a single intraperitoneal (ip) injection of 1.0 mg/kg body weight (bw) of partially purified salmon gonadotropin (SG-G100) or 0.2 mg/kg bw of Gly<sup>10</sup> [D-Ala<sup>6</sup>]LH-RH ethylamide luteinizing hormone releasing hormone analogue (LHRHa), a potent synthetic analogue of mammalian LHRH. Limited success (19.0% ovulation response) was achieved the following year using two doses of SG-G100 (1.0 and 0.5 mg/kg bw), SG-G100 in combination with LHRHa (0.5 ± 0.2 mg/kg bw), or LHRHa as a primer followed by a second dose (0.1, 0.2 mg/kg bw) three days later. Autopsy of

several unresponsive females at the end of the latter experiment revealed that most had immature ovaries.

In 1987, the effect of desGly<sup>10</sup> [D-Ala<sup>6</sup>] LH-RH ethylamide alone or in combination with domperidone, a dopamine antagonist, was investigated (Solar et al. 1988). Results suggested that dopaminergic control of gonadotropin release in this species is less apparent than in certain other teleosts (Cyprinids, Peter et al. 1986; catfish, van Oordt and Goos 1987). A second experiment in the same year investigated the effect of injections of D-Ala<sup>6</sup> LH-RH or microencapsulated D-Trp<sup>6</sup> LHRHa (Solar et al. 1988). Prior to the experimental work conducted in 1987, fish sex was tentatively identified by measuring plasma estradiol-17 $\beta$  levels. These preliminary determinations were later confirmed by ovarian catheterization.

A preliminary study conducted in 1988 investigated the influence of certain environmental parameters (water temperature and light) on the induction of ovulation. Maintenance of the fish in flowing chilled seawater (3–4° C) and darkness for about three months prior to hormonal treatment did

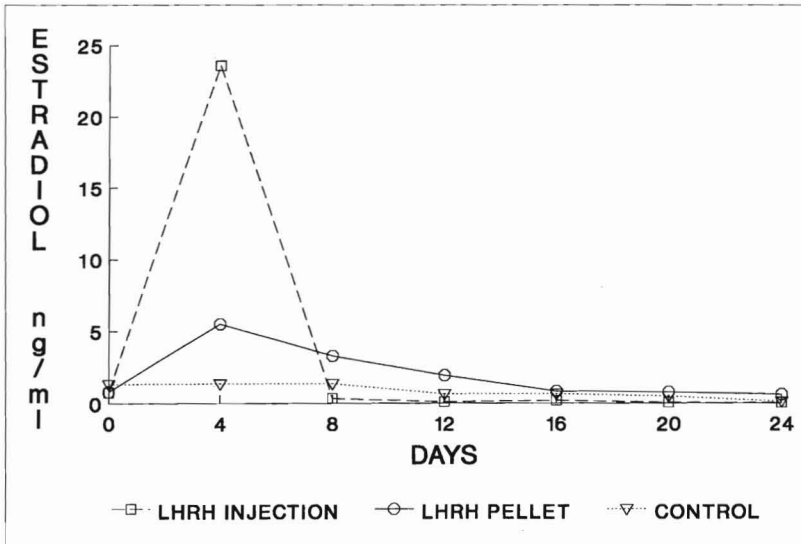


Figure 2

Plasma estradiol levels in female sablefish in response to intraperitoneal injection or cholesterol pellet implantation of des-Gly<sup>10</sup>[D-Ala<sup>6</sup>]LH-RH ethylamide. (Solar et al., unpubl. data 1989.)

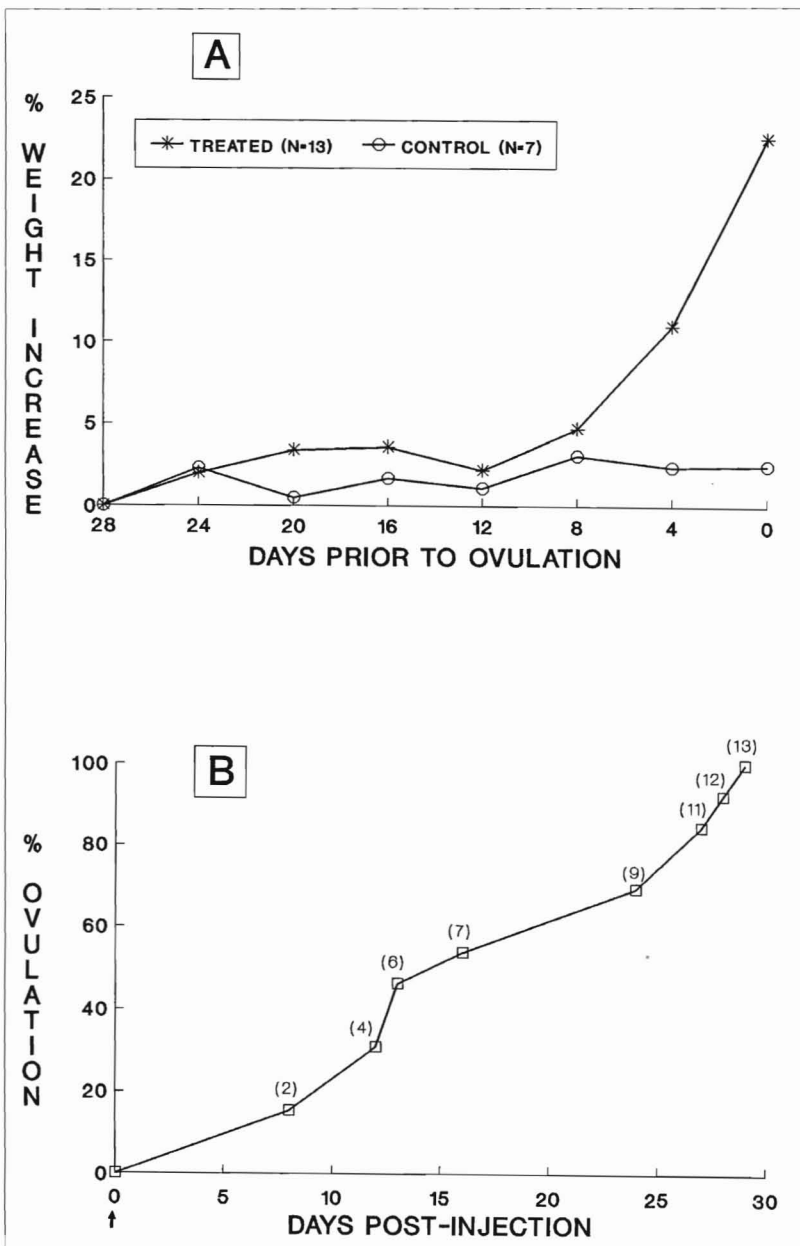
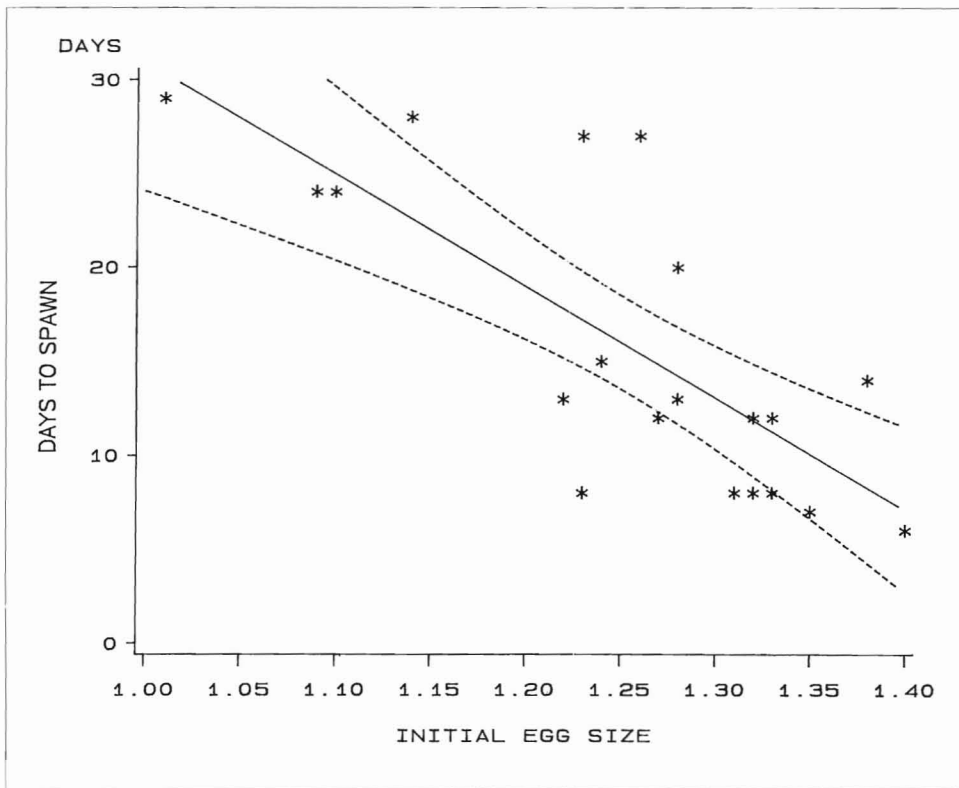


Figure 3

(A) Mean percent body weight changes in female sablefish treated with desGly<sup>10</sup>[D-Ala<sup>6</sup>]LH-RH ethylamide to induce ovulation, relative to body weight at the time of injection. (B) Cumulative percent ovulation response in sablefish shown in A. Numbers in brackets indicate actual number of fish ovulated and spawned to the date. Arrow indicates the timing of treatment. (Solar et al., unpubl. data 1989.)



**Figure 4**

Relationship between egg diameter (mm) at the time of injection and the duration of the latency period (days to ovulation) in hormonally induced female sablefish ( $r = 0.8$ ). Dotted lines represent 95% confidence limits for mean predicted values. (Solar et al., unpubl. data 1989.)

not improve the ovulation response relative to fish held on a natural photoperiod at 9–10° C (I. Solar et al. unpubl. data 1988).

In 1989, changes in plasma estradiol levels during the latency period (time span between drug administration and ovulation) were investigated following treatment with D-Ala<sup>6</sup>LHRHa by ip injection and slow-release cholesterol pellet implantation. Both injection and implantation of the 5% D-Ala<sup>6</sup>LHRHa pellet at the same dose (0.1 mg/Kg bw) induced ovulation in 100% of the experimental animals ( $n = 13$ ), while none of the control fish ( $n = 7$ ) ovulated. Changes in plasma estradiol levels measured by radioimmunoassay were followed at 4-day intervals during the 24 days postinjection. In both treatments there was an increase of the estrogen level which peaked at day 4 and decreased to levels similar to controls on day 8. The increase in plasma estradiol was more pronounced in the injected group than in those that had received the slow-release pellet (Fig. 2) (Solar et al. unpubl. data 1989). In a second experiment, during the same year, the oral administration of 1.5 mg/kg bw D-Ala<sup>6</sup> LH-RHa in two doses (1.0 and 0.5 mg/kg bw, respectively, 11 days apart) resulted in 75% of the fish ovulating within 18 days from the first treatment. The time course of uptake and net plasma presence of LHRHa during an 8-hour period following delivery was also determined thereby providing the first evidence for

biologically active nonapeptide absorption by the fish gut (Solar et al. 1990).

### Ovarian Hydration and Latency Period

The female fish responding to hormonal treatment have typically shown protrusion of the uro-genital papilla, gradual distention of the abdominal region, and an increase in total body weight of about 25% of the weight at the time of injection. The increase in body weight is normally slow during the days immediately following D-Ala<sup>6</sup> LH-RHa injection and very rapid during the three days prior to ovulation (Fig. 3). The increase in weight is due to oocyte hydration. The eggs, which at the time of injection are small and opaque (mean diameter  $1.25 \pm 0.1$  mm), became larger and transparent ( $2.2 \pm 0.1$  mm) at the time of ovulation (Solar et al. unpubl. data 1988).

Latency period has been variable ranging from six days to close to a month (mean  $15.8 \pm 8$  days). Statistical analysis showed that egg diameter at the time of injection and the number of days to spawn (latency period) are negatively correlated ( $r = 0.8$ ) (Fig. 4) (Solar et al. unpubl. data 1989).

### Artificial Fertilization and Incubation

The fecundity of female sablefish ranges from about 60,000 to close to one million eggs, depending on

fish size (Mason et al. 1983). The average female produces close to 200,000 eggs (G.A. McFarlane and M.W. Saunders, PBS unpubl. data). Success in fertilizing the eggs obtained from induced sablefish has been variable and generally lower than the fertilization rate of gametes obtained from mature sablefish collected from the wild during the peak spawning season. During the 1989 season, the best fertilization rates (those which were also followed by normal development to the 8-cell stage) were  $62.4 \pm 7.1\%$  for eggs from captive induced females and  $52.6 \pm 3.7\%$  for those from wild noninduced female. Average fertilization rates, however, were  $25.0 \pm 17.6\%$  (wild) and  $14.5 \pm 17.4\%$  (induced) (J. Jensen, PBS, pers. commun. June 1989).

Sablefish eggs are very fragile and easily injured during culture and therefore require special incubation techniques (Alderdice et al. 1988a, 1988b). The mature fertilized eggs are clear and normally remain suspended in the water column. The incubation period from fertilization to hatch lasts about 12 days at 6° C (McFarlane and Nagata 1988).

## Acknowledgments

Thanks are due to Dr. R.J. Beamish and Mr. G.A. McFarlane for making the fish used in these studies available to us and for continued support. We also thank J.O.T. Jensen and E. Groot for allowing us to quote unpublished fertilization and incubation data.

## Citations

Alderdice D.F., J.O.T. Jensen, and F.P.J. Velsen.

1988a. Preliminary trials on incubation of sablefish eggs (*Anoplopoma fimbria*). *Aquaculture* 69:271-290.

1988b. Incubation of sablefish (*Anoplopoma fimbria*) in a system designed for culture of fragile teleost eggs. *Aquaculture* 71:271-283.

Fujiwara, S., and D.G. Hankin.

1988. Sex ratio, spawning period, size and age at maturity of sablefish (*Anoplopoma fimbria*) off northern California. *Nippon Suisan Gakkaishi* 54:1333-1338.

Kennedy, W.A.

1972. Preliminary study of sablefish culture, a potential new industry. *J. Fish. Res. Board Can.* 29:207-210.

McFarlane, G.A. and R.J. Beamish.

1983. Biology of adult sablefish (*Anoplopoma fimbria*) in waters off western Canada. *In Proceedings of the International Sablefish Symposium*. Alaska Sea Grant Rep. 83-8:59-80.

McFarlane, G.A., and W.D. Nagata.

1988. Overview of sablefish mariculture and its potential for industry. *In Proceedings of the 4th Alaska Aquac. Conf.*; 18-21 Nov., Sitka, Alaska (S. Keller, ed.), p. 105-120. Alaska Sea Grant Report 88-4.

Mason, J.C., R.J. Beamish, and G.A. McFarlane.

1983. Sexual maturity, fecundity, spawning, and early life history of sablefish (*Anoplopoma fimbria*) off the Pacific coast of Canada. *Can. J. Fish. Aquat. Sci.* 40:2126-2134.

Peter, R.E., J.P. Chang, C.S. Nahorniak, R.J. Omeljaniuk, M. Sokolowska, S.H. Shish, and R. Billard.

1986. Interactions of catecholamines and GnRH in regulation of gonadotropin secretion in teleost fish. *Recent Prog. Horm. Res.* 42:513-548.

Solar, I.I., I.J. Baker, and E.M. Donaldson.

1987. Effect of salmon gonatropin and a gonadotropin releasing hormone analogue on ovarian hydration and ovulation in captive sablefish (*Anoplopoma fimbria*). *Aquaculture* 62:319-325.

Solar, I.I., I.J. Baker, and E.M. Donaldson.

1988. Induced ovulation in sablefish (*Anoplopoma fimbria*) using gonadotropin releasing hormone analogues. *In Proceedings of the 3rd. Int. Symp. on Reprod. Physiol. of Fish*; 2-7 Aug. 1987, D.R. Idler, L.W. Crim and J.M. Walsh (editors) St. John's, Newfoundland. *Mem. Univ., Newfoundland*.

Solar I.I., E. McLean, I.J. Baker, N.N. Sherwood and E. M. Donaldson.

1990. Induced ovulation of sablefish (*Anoplopoma fimbria*) following oral administration of desGly<sup>10</sup>(D-Ala<sup>6</sup>)LH-RH ethylamide. *Fish Physiol. Biochem.* 8:497-499.

van Oordt, P.G.W.J., and H.J.Th. Goos.

1987. The African catfish, *Clarias gariepinus*, a model for the study of reproductive endocrinology in teleosts. *Aquaculture* 63:15-26.



# Geoduck Culture in Washington State: Reproductive Development and Spawning

J. HAROLD BEATTIE and C. LYNN GOODWIN

*Washington State Department of Fisheries  
Point Whitney Laboratory  
Brinnon, WA 98320*

## Abstract

The Washington State Department of Fisheries operates and maintains a hatchery for the geoduck clam (*Panopea abrupta*). The purposes of this hatchery are to provide clam seed to plant subtidal areas which commercial harvesters have depleted, and to eventually double the present annual harvest from 2,000 to 4,000 metric tons. Hatchery operations occur from March through July, centering on the peak of natural spawning in late spring. We induce spawning by elevating seawater temperatures to 15° C and increasing algal concentrations. In our hatchery, females release an average of 2 to 10 million eggs per spawning.

## Introduction

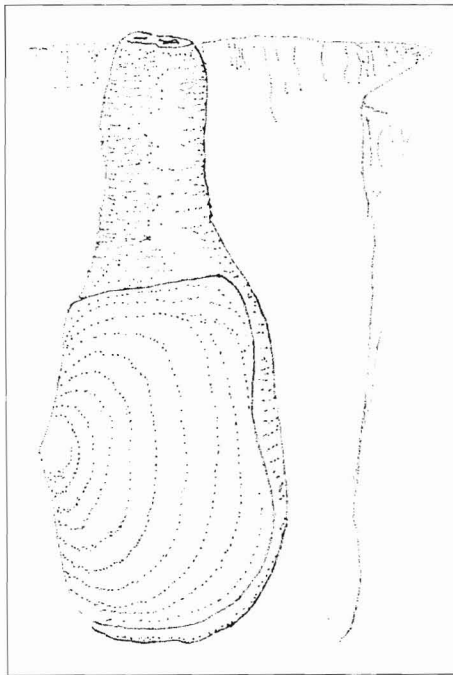
The geoduck, *Panopea abrupta*, is the largest burrowing clam in the world. These clams live about a meter deep in the sediment and have long siphons which they can extend up their burrows for feeding, respiration, and excretion (Fig. 1). Extensive populations of geoducks occur intertidally and subtidally in Washington State throughout Puget Sound and Hood Canal. The average weight for adults taken from Washington waters is about 0.8 kg; however, records show specimens in excess of 5 kg (Anderson 1971). The Washington State Department of Fisheries (WDF) has established a maximum sustainable yield estimate for geoducks in Washington State at 2,000 metric tons (t) per year. Geoducks are very long lived; Shaul and Goodwin (1982) recorded ages of adults in excess of 100 years. Buried beyond the reach of natural predators, having no known diseases, and exhibiting low recruitment, geoducks tend to form stable, uniformly sized populations.

The commercial harvest of subtidal geoducks in Washington State began in 1970. Prior to that year, state regulations permitted only personal use of a harvest from hand digging. During the late 1960's, surveys by the WDF documented extensive subtidal beds of geoducks in Puget Sound. In 1970, the Washington State legislature changed the regulations to

allow commercial subtidal harvest of these clams. This act not only created the commercial fishery for this resource but designated the WDF and the Washington State Department of Natural Resources (DNR) as cooperative managers. The state sells the right to harvest subtidal tracts of geoducks to companies whose divers excavate the clams with water jets. A portion of the proceeds from these lease fees are used to fund compliance, management, patrol, and enhancement efforts by the DNR and the WDF.

In 1972, the WDF began conducting subtidal surveys of harvested tracts. By 1975, the results of these surveys showed that, although in many areas recruitment was sufficient to maintain healthy population levels, in some areas there was little or no recruitment. Thus, in 1982, the DNR and WDF decided to implement an enhancement program which would replenish poorly recruiting areas.

Central to this enhancement effort was the establishment of a hatchery and nursery program. Using data from Point Whitney Laboratory research (Goodwin 1973, Goodwin et al. 1979), this program adapted shellfish hatchery and nursery techniques developed for oysters and hard shell clams. Moving through experimental, pilot, and commercial scale phases, the enhancement project targeted a goal of doubling the annual harvest of geoducks from 2,000 to 4,000 t.



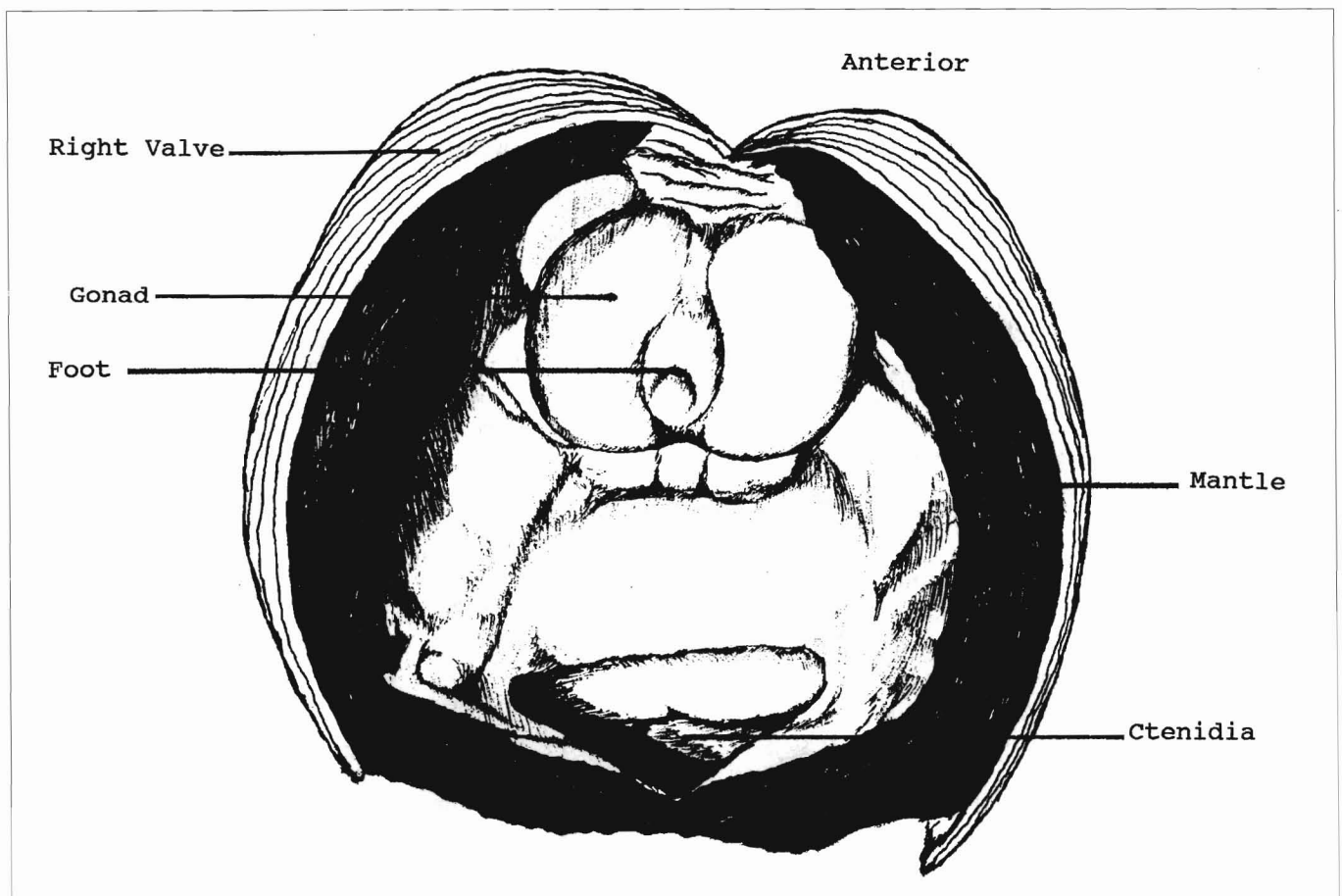
**Figure 1**

A cut away drawing of a geoduck in its natural habitat. Shell height is 16 cm. (From King 1986.)

## Reproductive Development

Conducting a successful hatchery program depends on understanding the physiology and timing of reproduction. Like most other mollusks, geoducks have no external indicators of gender. They are dioecious and sexually intransmutable; hermaphroditic individuals are rare. The gonadal ducts are intertwined with the intestinal mass, and together they form two large spheroids which lie on each side of a medial line (Fig. 2).

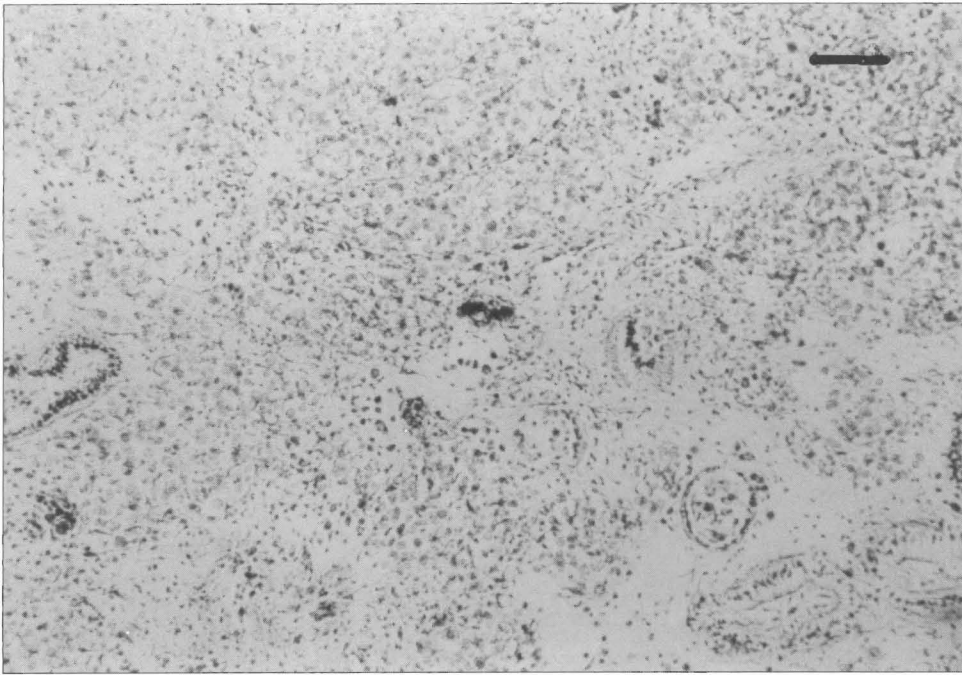
When they are approximately 3 years old, male geoducks become sexually mature; female geoducks begin egg production when they are about 4 years old (Anderson 1971). When mature, the gonadal tissues begin a cycle of development and maturation which leads to spawning and to tissue resorption or both. They continue this cycle for most of their lives. Sloan and Robinson (1984) found reproductively active specimens that were 105 years of age. Anderson (1971) and Goodwin (1976) found ripe geoducks in at least eight months of the year from November through June.



**Figure 2**

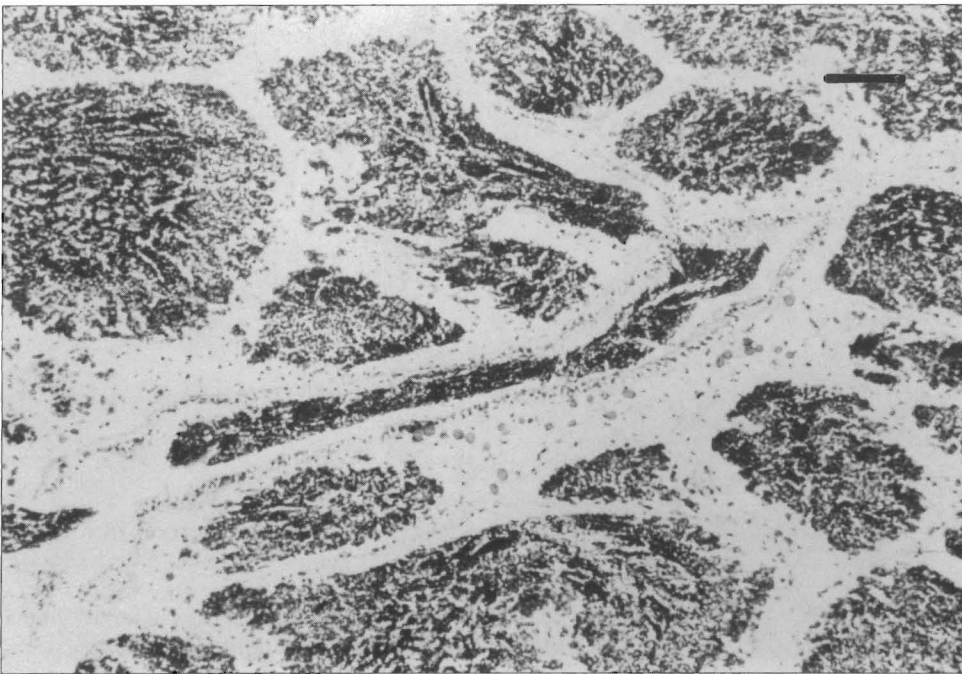
The gross morphology and location of the gonads in geoducks. Shell length is 12 cm. Drawing by Don Velasquez, Univ. Washington.





**Figure 3**

Histological section showing the early active phase of male gonad with only a few pockets of sperm showing. (Scale bar = 100  $\mu$ m; stain = Harris' hematoxylin and eosin.)



**Figure 4**

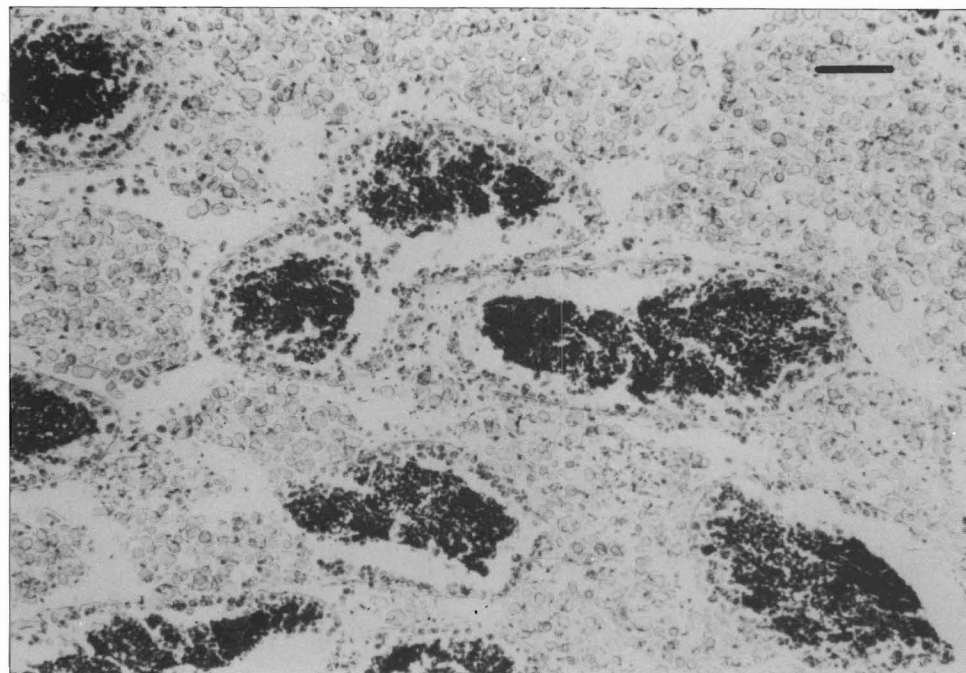
Histological section of a ripe male, follicles packed with sperm. (Scale bar = 100  $\mu$ m; stain = Harris' hematoxylin and eosin.)

### Histology: Spermatogenesis

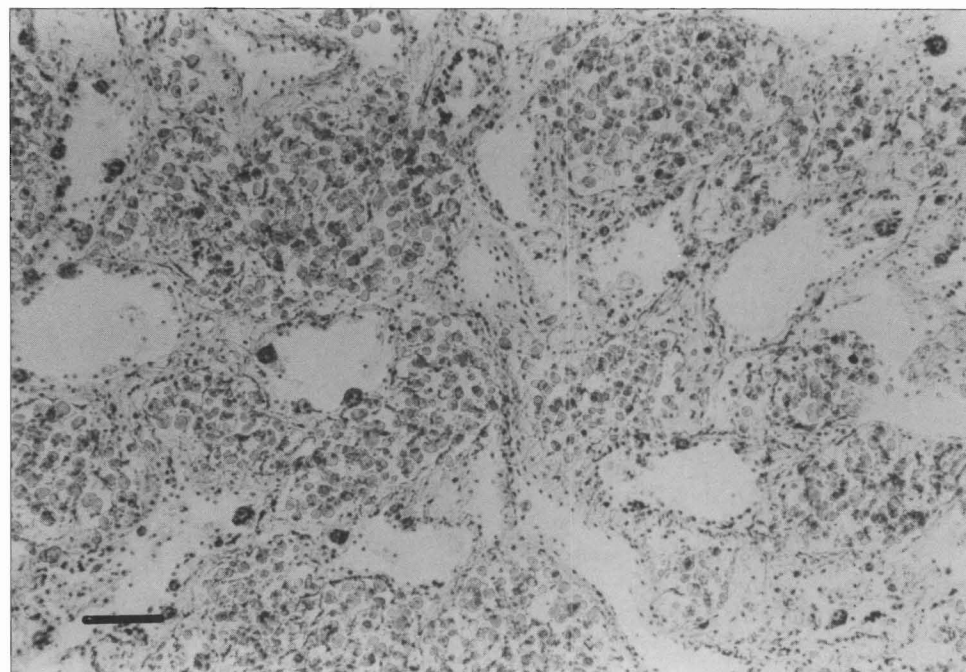
In the early stage (September through December), the reproductive follicles are small and possess only pockets of sperm (Fig. 3). When the animals reach maturation (November through June), the follicles are packed with sperm (Fig. 4). Once spawning commences (December through July), the follicles partially empty (Fig. 5); and when spent (March through August), the follicles partially collapse and connective tissue proliferates in the gonads.

### Histology: Oogenesis

In the early stages (September through November), ovocytes are just beginning to form in the ovarian follicles (Fig. 6). During the late active stage (September through January), ovocytes begin to fill the follicles, clinging to the ovarian walls by a nutritive stalk (Fig. 7). When females are ripe (November through June), the eggs detach and float free in the lumen (Fig. 8). By the partially spent stage (January through July), fewer eggs exist and there are very few,



**Figure 5**  
Histological section of a partially spawned male. (Scale bar = 100  $\mu\text{m}$ ; stain = Harris' hematoxylin and eosin.)



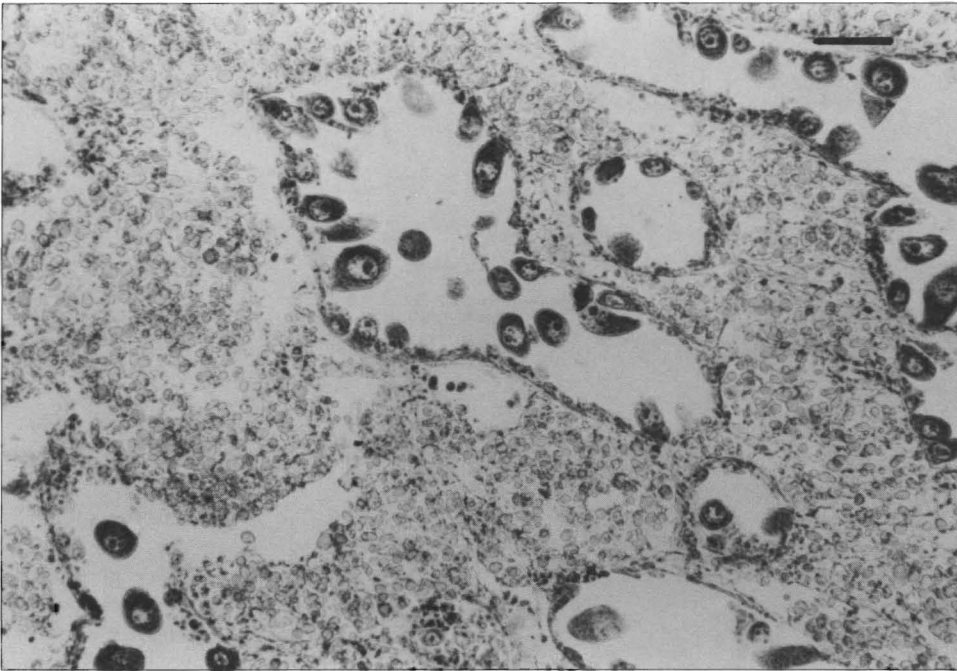
**Figure 6**  
Histological section of a female geoduck gonad. A few ovocytes are just showing. (Scale bar = 100  $\mu\text{m}$ ; stain = Harris' hematoxylin and eosin.)

if any, developing ova. Figure 9 illustrates a nearly spent female in which the ovarian follicles are empty and leucocytes may be present (May through August).

### Reproductive Cycle \_\_\_\_\_

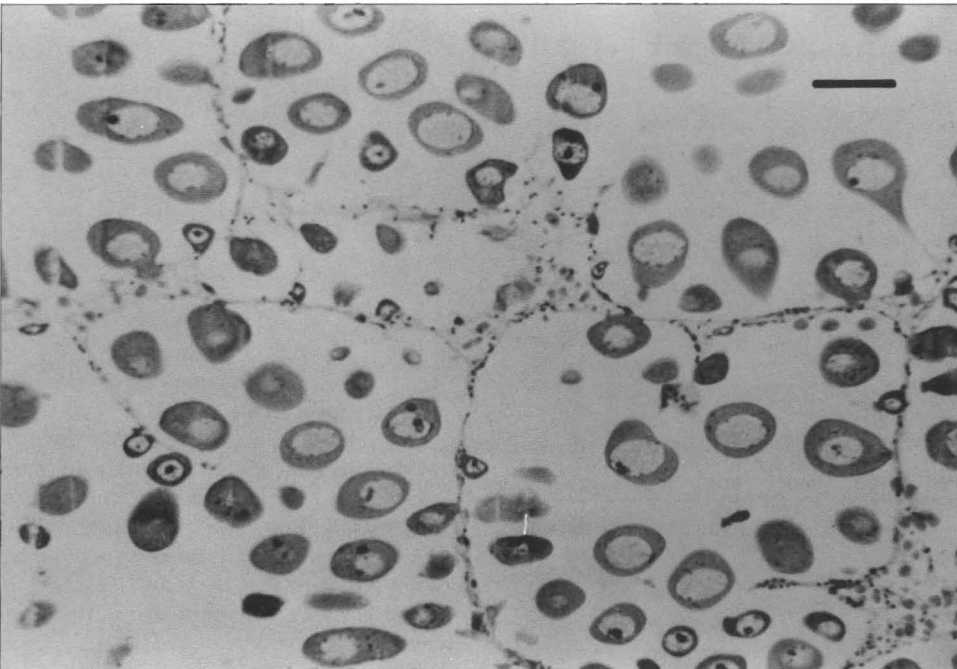
Male geoducks begin gonadal development during September. By November some are ripe. Though some spawn earlier, they start mass spawning in March as indicated by the first occurrence of spent

animals. By August, they are entirely spawned and the spawning cycle begins anew (Fig. 10). Females with ripe gonads occur from fall until early summer; however, mass spawning only begins in April (again as evidenced by the occurrence of spent animals), and is completed by August (Fig. 11). The temporal window for spawning in the animals examined by Anderson (1971) began from the time of first spawning in January and continued until August and that the majority of spawning occurred in May and June. In obtaining and spawning geoducks for our hatchery work, we have found that animals from south



**Figure 7**

Histological section of the late active stage of female geoduck. (Scale bar = 100  $\mu$ m; stain = Harris' hematoxylin and eosin.)



**Figure 8**

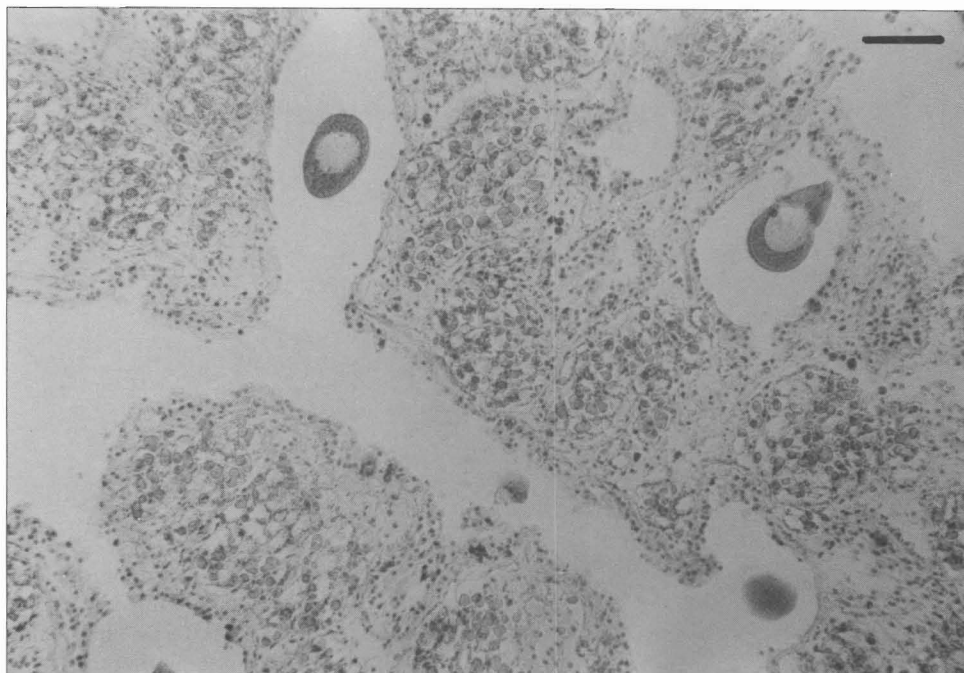
Histological section from a ripe female geoduck gonad. Eggs are floating free in the lumen. (Scale bar = 100  $\mu$ m; stain = Harris' hematoxylin and eosin.)

Puget Sound ripen two to three weeks earlier than those from north Puget Sound. We attribute this phenomenon to the warmer waters and high productivity characteristic of south Puget Sound.

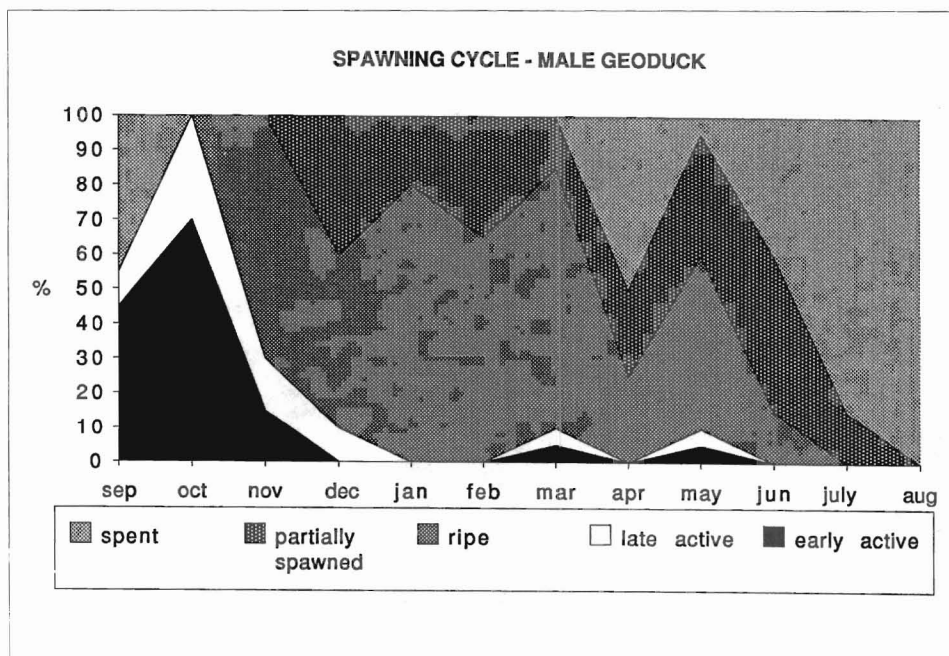
### Spawning in the Hatchery

To obtain mass spawnings earlier than they occur in nature (March and April), we accelerated gonadal development in February. We ripened the broodstock in five tanks (1.2  $\times$  2.2  $\times$  0.6 m). Each of

these tanks can hold 160 geoducks. The conditions in the tank were the following: flow-through ambient (10° C), unfiltered sea water and a constant density of about 5,000 cells/mL of cultured diatoms (*Chaetoceros mulleri*). After two to four weeks in these conditions, geoducks will usually spawn. The males are slightly precocious: even though a 1:1 proportion exists between the sexes among the geoducks, we often found that a disproportionate number of males spawned in the early season. In March 1990, for example, of the 684 animals under culture 302 males spawned, but only 178 females released eggs. By



**Figure 9**  
 Histological section from a nearly spent female geoduck. A few residential ova are evident. (Scale bar = 100 μm; stain = Harris' hematoxylin and eosin.)

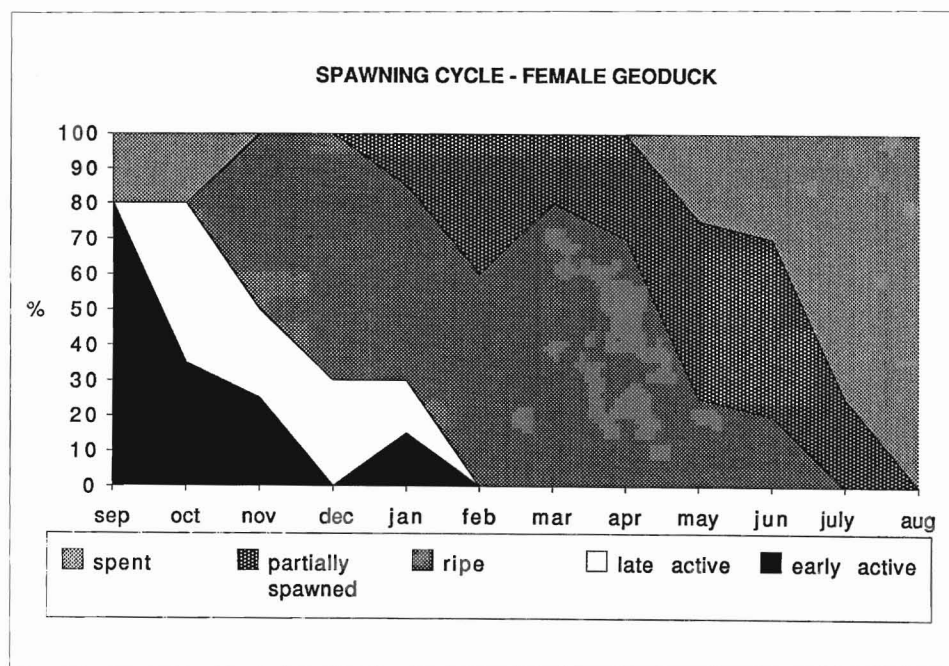


**Figure 10**  
 Area graph depicting the annual reproductive cycle of male geoducks as represented by the percentage of animals in each gonadogenic stage at the time of sampling. The preponderance of spawning in nature occurs between the first and last occurrences of spent animals. (Data from Anderson 1971.)

April, naturally occurring gonadogenesis precludes the need for a ripening period. During this time, we could bring animals directly to the hatchery for spawning, and males and females would spawn in approximately equal numbers. We generally attempted to spawn a group of at least 100 animals at a time. On average, only 20 to 50 percent of the females spawned well. Each female will spawn from 2 to 10 million eggs. Thus, an average spawn will result in 60 million eggs.

To induce geoducks to spawn, we stopped the water flow and increased algal density in the spawning tank to a range of 100,000 to 200,000 cells/mL. Since algae in culture live at 18 to 20° C, this influx of algae causes a rise in water temperature in the spawning tank. After the temperature reaches 15° C, we begin a flow of 14–15° C seawater.

When spawning commenced, we determined the sex of each animal by observing its spawn: In a flashlight beam, sperm give the appearance of milk

**Figure 11**

Area graph depicting the annual reproductive cycle of female geoducks as represented by the percentage of animals in each gonadogenic stage at the time of sampling. The preponderance of spawning in nature occurs between the first and last occurrences of spent animals. (Data from Anderson 1971.)

mixed with water, whereas the eggs look like dust suspended in the air. We removed the spawning animals from the tank and placed them into several spawning trays (30 × 46 × 15 cm) filled with 14–15° C seawater keeping males separate from females.

Once they had completely spawned, we removed the females and fertilized the ova with a few milliliters of sperm suspension from the male spawning tray(s). For cleaning the fertilized eggs we used two screens. Each of these screens is constructed by stretching and attaching precision woven nylon fabric (Nytex®) across one end of a 38-cm diameter PVC tube. Using 14° C seawater, we gently washed the zygotes through a 130-micron screen onto a 35-micron screen, thus removing larger and smaller particles and excess sperm. One of the problems we encountered with using high densities of phytoplankton to induce spawning was that, while spawning, the well fed geoducks produced excessive amounts of feces and pseudofeces. This material mixed with the eggs, and made washing through the 35-micron screens a tedious process.

After they were washed, we placed the fertilized eggs into a 20-liter container of 15° C seawater. To monitor development, we microscopically examined samples for polar bodies and first cleavage. When we were assured that normal development was occurring, we placed the zygotes in a 20,000 L tank of 14° C seawater.

At 14° C, embryonic development was completed in 72 hours and ended at the first veliger form. The veliger larval period lasts 25 days at 17° C. After they had metamorphosed, we moved the geoduck juve-

niles to a sand substrate nursery. Over the next 90 days, they grew to seed size: an average of 9 mm shell height. During the past four years, the WDF geoduck hatchery has produced and planted 18 million seed. In a good growing area, geoducks will grow to a 0.8-kg mean harvest weight in five to six years. Thus, with an expected field survival of between 0.5 and 1.0%, we anticipate that we will have enhanced the resource by between 70 and 140 t by the time these animals reach harvest size.

## Acknowledgments

The authors thank Alex Bradbury, of the Washington Department of Fisheries for his assistance with the manuscript.

## Citations

- Anderson, A.M., Jr.  
1971. Spawning, growth and spatial distribution of the geoduck clam, *Panope generosa* (Gould) in Hood Canal, Washington. Ph.D. diss., Univ. Washington, Seattle, 133 p.
- Goodwin, C.L.  
1973. Effects of salinity and temperature on embryos of the geoduck clam (*Panope generosa*). Proc. Nat. Shellfisheries Assoc. 63:93–95.
- Goodwin, C. L.  
1976. Observations on spawning and growth of subtidal geoducks (*Panope generosa*, Gould). Proc. Nat. Shellfisheries Assoc. 65:49–58.

Goodwin, C.L., W. Shaul, and C. Budd

1979. Larval development of the geoduck clam (*Panope generosa*, Gould). Proc. Nat. Shellfisheries Assoc. 69:73-76.

King, J.J.

1986. Juvenile feeding ontogeny of the geoduck *Panope abrupta* (Bivalvia: Saxicavacea), and comparative ontogeny and evolution of feeding. Ph.D. diss., University of Victoria, Victoria, BC, 281 p.

Shaul, W., and C.L. Goodwin

1982. Geoduck (*Panope generosa*: Bivalvia) age as determined by internal growth lines in the shell. Can. J. Fish Aquat. Sci. 39:632-636.

Sloan, N.A. and S.M.C. Robinson

1984. Age and gonad development in the geoduck clam *Panope abrupta* (Conrad) from southern British Columbia, Canada. J. Shellfish Res. 4(2):131-137.

# Ecology of *Sargassum* spp. and *Sargassum* Forest Formation

JUN-ICHI TSUKIDATE

*Nansei National Fisheries Research Institute  
Maruishi 2-17-5, Ohno Saeki  
Hiroshima 739-04, Japan*

## Abstract

*Sargassum* spp. are distributed in the coastal waters of Japan from the northernmost island of Hokkaido down to the southern island of Kyushu. The forests they create in the sublittoral zone of the sea are important spawning and rearing grounds for fish and shellfish. A study of *Sargassum* spp. was conducted to support a project of creating *Sargassum* forests. Methods for producing these forests are described. The majority of species started growth in autumn as the water temperature began to fall. The release of oospores was also temperature dependent and varied between species. Many species matured between May and June when the rising water temperature approaches 18° C. Contrary to previous findings, oospores were released irrespective of the tide. Both mono- and multi-species forests were created and maintained for two years in Hiroshima before being invaded by other seaweed species.

## Introduction

*Sargassum* spp. (Fig. 1) are members of the brown algae family and are among the most highly developed seaweeds in both their morphology and life cycle. Morphologically, they have a holdfast, stipe, and lamina and thus resemble a terrestrial tree. Having no asexual stage in their life history (Fig. 2), each plant is a gametophyte producing both female (oospores) and male gametes (spermatozoids). They are distributed throughout Japan from the northernmost island of Hokkaido down to the southern island of Kyushu (Arasaki 1984). Most species grow in a wide range of water temperatures and form forests in the sublittoral zone of the sea that are known to be spawning, nursery, and feeding areas for many kinds of fish, shellfish, and other marine organisms.

This paper describes the growth and maturation of *Sargassum* spp. and the propagation of *Sargassum* forests with artificial reefs and seeded string.

## Oospore Liberation and Growth of *Sargassum*

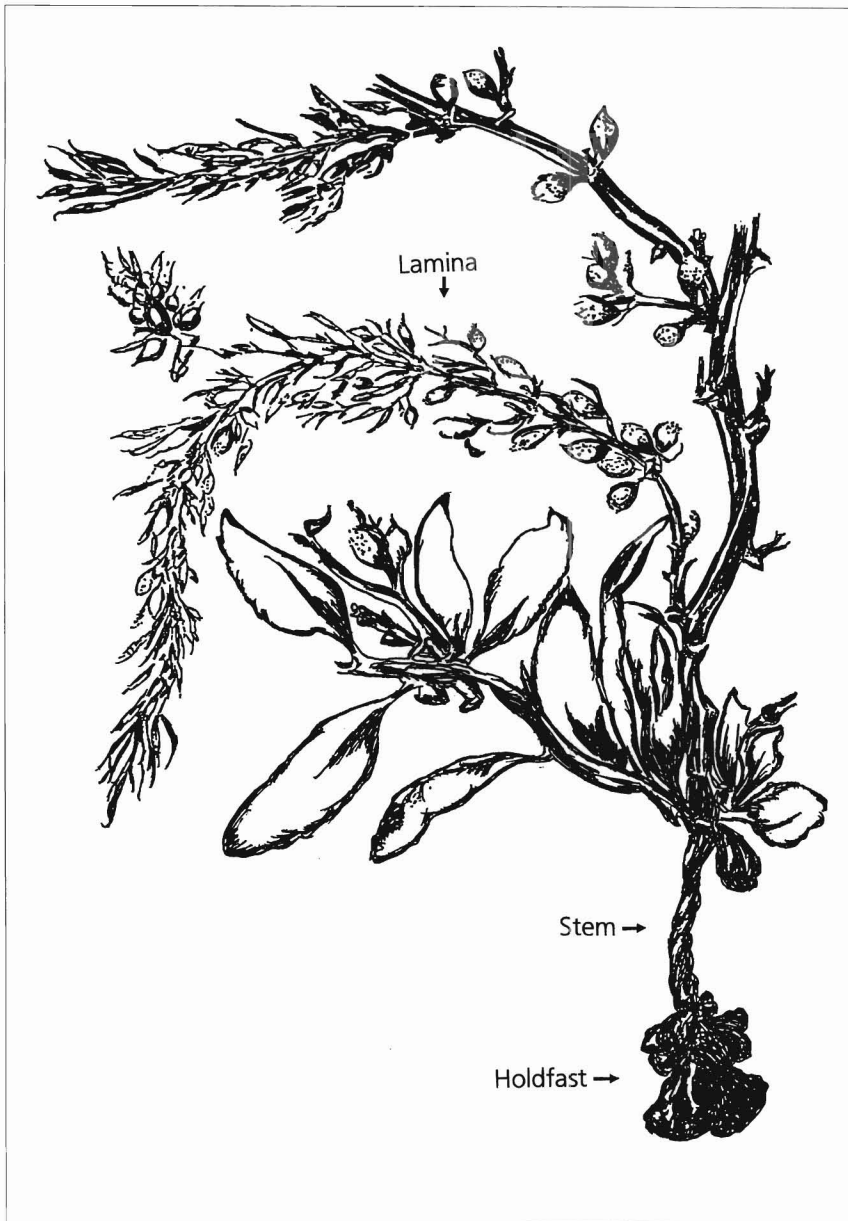
The optimum time for oospore liberation varied among species with respect to season and water temperature (Table 1). At a research area in Fukuoka

Prefecture, *Cystophyllum sisymbrioides* was the first to release oospores at 14° C in March. *Sargassum horneri*, *S. micracanthum*, *S. tortile*, and *S. muticum* released oospores at around 15° C in April (Okuda 1981). Many species matured from May to June when the water temperature rises to 18° C and higher.

It is generally thought that oospores are discharged at high tide but we found oospore were released irrespective of the tide (Okuda 1981, 1982) (Fig. 3). *S. micracanthum* liberated oospores every seventh or eighth day, *S. patens* at 3-day intervals, and most other species every fourth day.

## *Sargassum* Forest Formation

Most *Sargassum* spp. start to grow in autumn when the water temperature begins to fall. Figure 4 shows the growth of several species on a wet weight basis at one of the research areas near Hiroshima, where a forest spreads for about 1.1–1.4 ha (Takaba and Mizokami 1982). *S. horneri* and *S. tortile* grows profusely here from November to the following January. The largest standing crop for the four species was 15 kg wet weight/m<sup>2</sup> in 1981, and production is estimated to be 15–21 kg wet weight/(m<sup>2</sup> • yr). The growth of *S. ringgoldianum* in another area located off Tokushima Prefecture is shown in Figure 5 (Nakahisa



**Figure 1**  
Morphology of *Sargassum*.

and Kojima 1982). This species matures in autumn at around 22° C with the largest growth observed in October just before maturation. The standing crop at this time was 5–6 kg wet weight/m<sup>2</sup>.

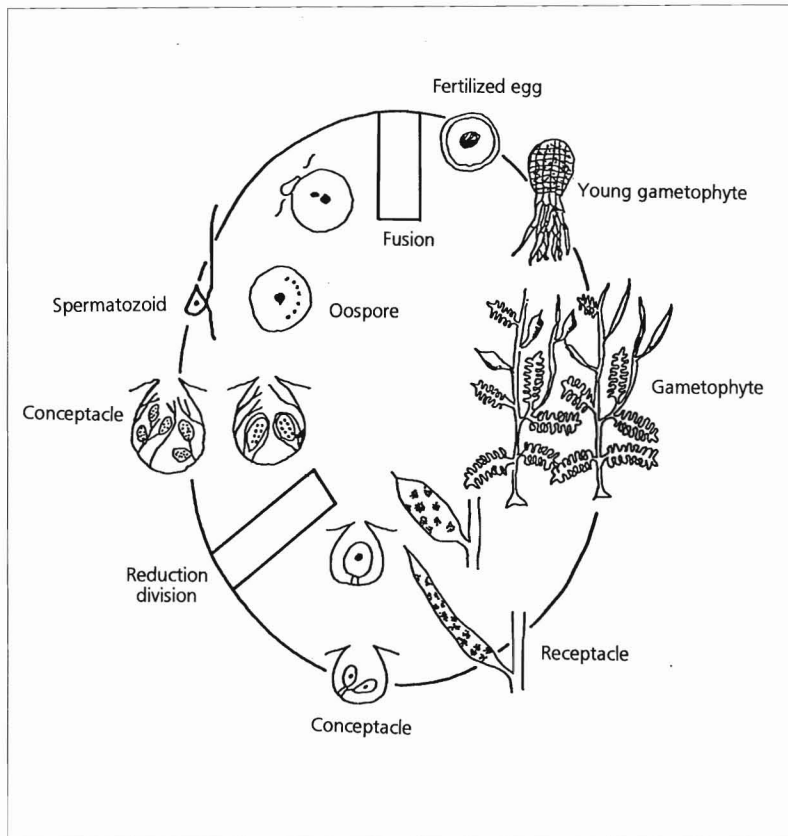
The environmental characteristics of the water in the research field off Yashiro Island are summarized in Table 2. (Takemoto et al. 1984). The temperature at the bottom is lower than that at the surface in August, although no difference in temperature was found in November. Salinity was observed to be a little low in August. Dissolved oxygen concentrations were around 5 mg/L and saturated in both August and November. Turbidity changed from 0.2 to 1.6 ppm depending on the tide and current. Chemical

oxygen demand ranged from 0.15 to 0.85 ppm. Nutrient concentrations fluctuated during the year. Dissolved inorganic nitrogen was 1–2 µg-atoms/L in August and 4–5 µg-atoms/L in November.

### Mono-Species Culture

Figure 6 shows an outline of the artificial reefs placed in the sea for the various *Sargassum* forest formations (Komoto et al. 1987). Fifty concrete blocks were placed in both the eastern (E) and western (W) zones of the study area. The E-zone was close to a natural *Sargassum* forest, while the W-zone was about



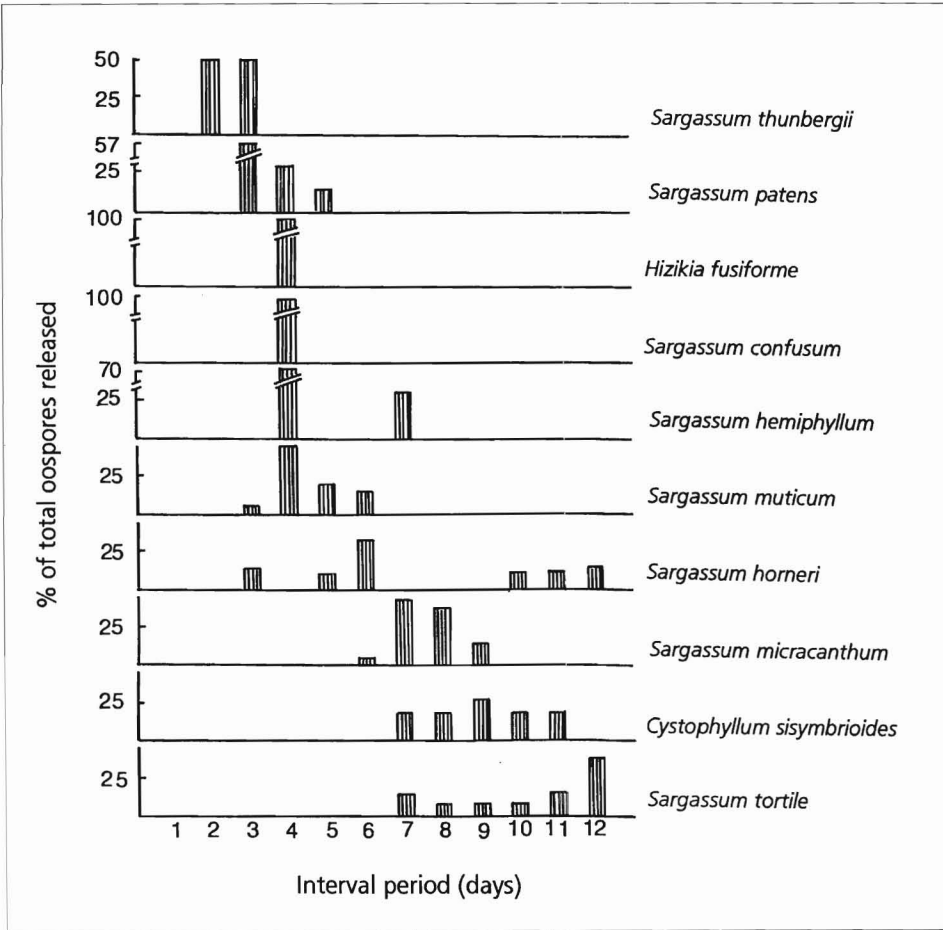


**Figure 2**  
Life Cycle of *Sargassum* spp.

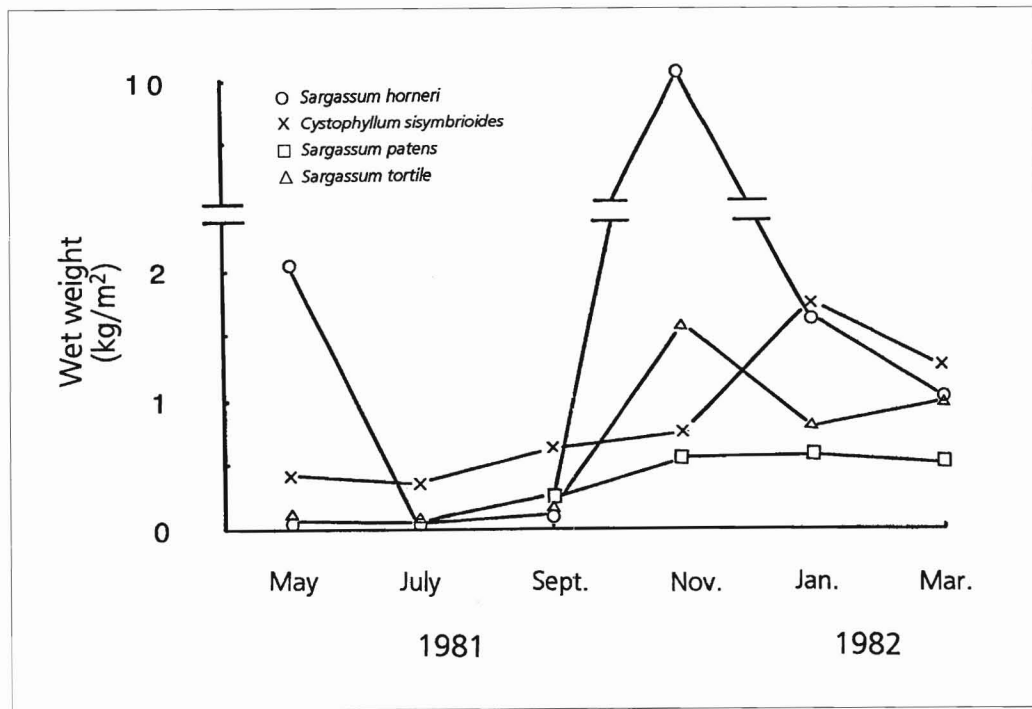
**Table 1**  
Maturing season of *Sargassum* spp. and coastal water temperature (Okuda 1982)

Species	Month and Temperature
<i>Cystophyllum sisymbrioides</i>	Late March 14° C
<i>Sargassum horneri</i> <i>S. micracanthum</i> <i>S. tortile</i> <i>S. muticum</i>	Middle and late April 15–16° C
<i>S. patens</i> <i>S. hemiphyllum</i>	Early and middle May 18° C
<i>S. thunbergii</i>	Middle and late May 19–20° C
<i>Hijikia fusiforme</i>	late May and early June 21° C
<i>S. ringgoldianum</i>	Early and middle October 22° C

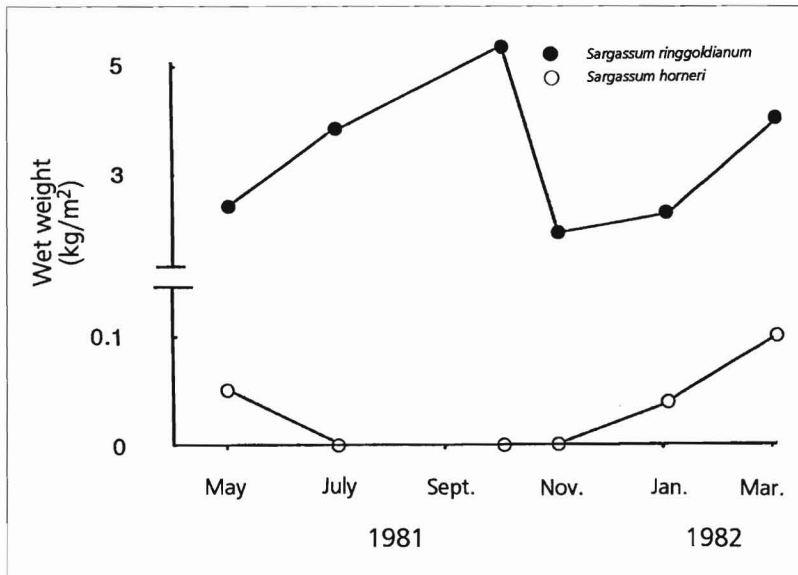
50 m from it. The natural forest was dominated by several species of *Sargassum* and *Ecklonia cava*. The seasonal variation in the number of individuals of *S. patens* is shown in Figure 7 (Yoshikawa and Tsukidate 1984, 1985). Mortality was very high during the first three months; afterwards the number of plants stayed at the level seen in the natural forests. The seasonal variation in the total length of *S. patens* is shown in Figure 8 (Yoshikawa and Tsukidate 1986). The total length increased toward the following spring, reaching an average of about 70 cm. Length declined reaching its smallest size of 20 cm in October, followed by another increase to between 50 and 60 cm in February. Thus the maximum growth stage was found between winter and spring. Figure 9 shows the seasonal variation in wet weight of *S. patens* (Yoshikawa and Tsukidate 1986). The growth pattern was identical to that of total length. These forests diminished in the summer months but enlarged again during this winter to spring period. However, in the third year, they did not enlarge their biomass because of the invasion of other seaweeds such as *Ecklonia cava* and *Padina arborescens*. Thus, *Sargassum* forests were created and maintained in a roughly 1,000 m<sup>2</sup> area with artificially prepared reefs by using seeded string for at least two years.



**Figure 3**  
Interval of oospore liberation in *Sargassum* spp. (Okuda 1982).



**Figure 4**  
Seasonal variations in wet weight of *Sargassum* spp. (Takaba and Mizogami 1982).



**Figure 5**  
Seasonal variations in wet weight of *Sargassum ringgoldianum* (Nakahisa and Kojima 1982; Nakahisa et al. 1983).

**Table 2**

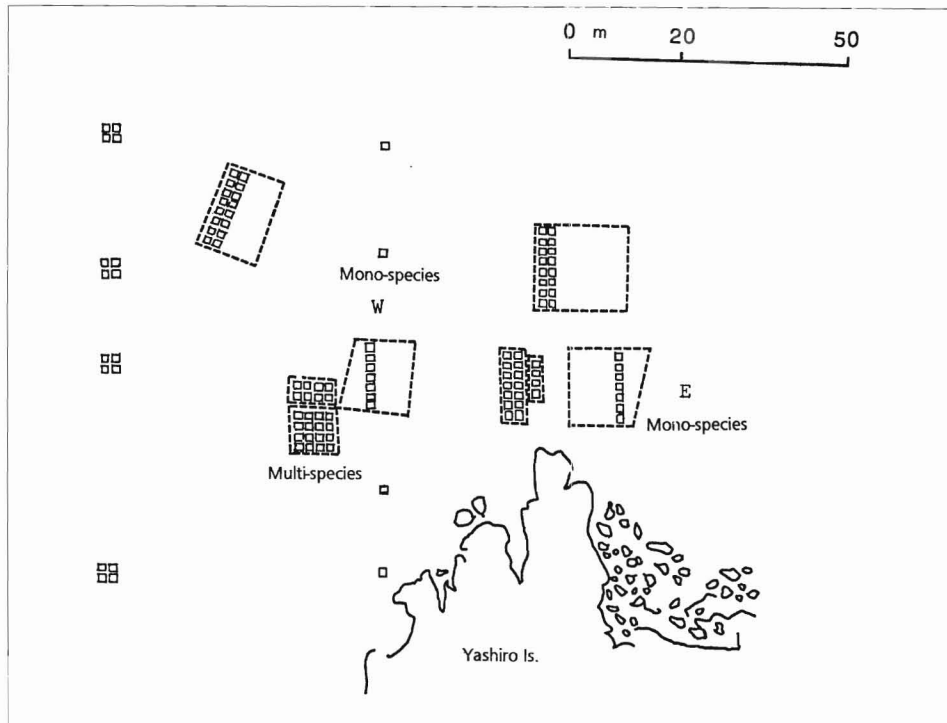
Environmental characteristics of the research field in Yashiro Island. (Takemoto et al. 1984.) S = surface; B = bottom. DO = dissolved oxygen; COD = chemical oxygen demand; DIN = dissolved inorganic nitrogen. tr = trace.

Survey season	Survey station	Survey time	Water depth (m)	Layer (m)	Water temp. (°C)	Salinity (‰)	DO (mg/L)	pH	Turbidity (ppm)	COD (ppm)	PO <sub>3</sub> -P (µg-at/L)	DIN (µg-at/L)	NH <sub>4</sub> -N (µg-at/L)	NO <sub>2</sub> -N (µg-at/L)	NO <sub>3</sub> -N (µg-at/L)
1983 Aug. 30	L-4•4	10:39		S	25.4	32.12	5.57	8.12	0.18	0.64	0.22	1.75	1.22	tr	0.53
		10:37	3.5	B	24.8	32.18	5.60	8.15	1.12	0.37	tr	1.85	1.27	tr	0.58
	L-4•8	10:56		S	25.6	32.12	5.48	8.10	0.10	0.85	0.12	1.69	0.55	tr	1.14
		10:54	7.0	B	24.4	32.28	5.22	8.10	0.85	0.24	0.10	1.73	0.70	0.13	0.90
	L-12•4	11:02		S	25.4	32.18	5.80	8.12	0.15	0.14	tr	1.11	0.75	tr	0.36
		11:00	7.0	B	23.9	32.48	5.58	8.15	7.20	0.24	0.17	2.04	0.82	0.37	0.85
L-12•8	11:11		S	25.4	32.12	6.07	8.12	0.23	0.32	0.11	0.95	0.42	tr	0.53	
	11:09	4.0	B	24.7	32.30	5.55	8.15	0.65	0.16	0.11	0.95	0.43	tr	0.52	
1983 Nov. 30	L-4•2			S	16.6	32.88	5.62	8.15	0.20	0.43	0.42	3.67	1.80	0.83	1.04
		11:52	2.5	B	16.8		5.72	8.15	1.00	0.48	0.42	4.41	2.25	0.88	1.28
	L-4•4			S	16.4	32.88	5.58	8.20	0.45	0.53	0.48	6.47	2.21	0.84	3.42
		11:55	4.0	B	16.8	32.90	5.59	8.19	0.95	0.77	0.38	3.54	1.53	0.87	1.14
	L-4•8			S	17.0	32.94	5.56	8.20	0.55	0.51	0.42	4.83	2.40	1.00	1.43
		12:00	12.0	B	16.8	32.91	5.58	8.15	1.65	0.46	0.42	4.70	2.43	0.97	1.30
	L-12•4			S	16.4	32.91	5.56	8.20	0.85	0.58	0.39	3.94	2.08	0.83	1.03
		12:05	3.5	B	16.7	32.86	5.50	8.20	0.60	0.45	0.42	3.76	1.72	0.84	1.20
L-12•8			S	17.0	32.94	5.87	8.20	0.40	0.56	0.39	3.56	1.38	0.95	1.23	
	12:08	9.0	B	16.8	32.92	5.37	8.20	0.45	0.42	0.40	3.73	1.41	1.00	1.32	

### Multi-Species Culture

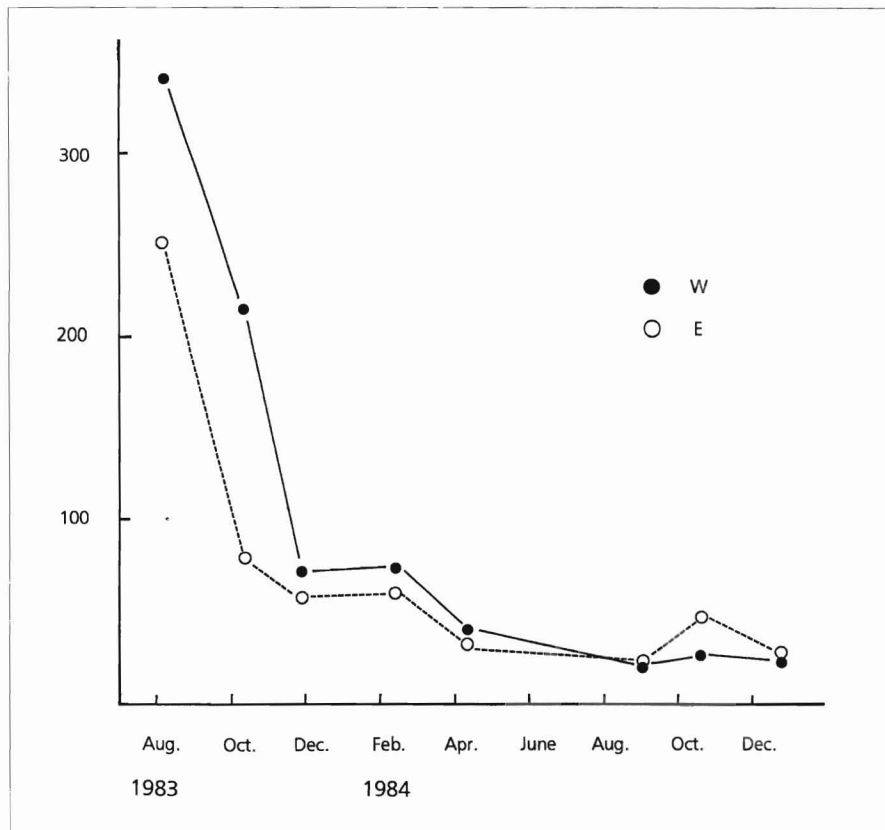
Two species of *Sargassum* out of three, namely *S. patens*, *S. piluliferum*, and *S. ringgoldianum* were combined and planted on the concrete blocks at the same time. Seeded strings with embryos were wrapped around the blocks alternately. Thus, as shown in Figure 10, eight strings with *S. patens* and eight with *S. piluliferum* resulted (Komoto et al. 1987).

The ratios in wet weight of *S. piluliferum* to *S. patens* are seen in Figure 11 (Komoto et al. 1988). *S. piluliferum* dominated the artificial reefs in the first year and also demonstrated a superior regenerative ability in the second and third years. In the first year, *S. piluliferum* accounted for 74.7% of the combined wet weight of the two species, 86.5% in the second year and 87.7% in the third year. Figure 12 shows the ratios in wet weight per single concrete block of



**Figure 6**

An outline of the artificial reef for seaweeds off Yashiro Island (Komoto et al. 1987). W = western zone of the study area; E = eastern zone of the study area in the Seto Inland Sea, off Yashiro Island.



**Figure 7**

Seasonal variations in number of individuals per 75 cm string of *Sargassum patens* (Yoshikawa and Tsukidate 1984, 1985). ● = western zone of the study area; ○ = eastern zone of the study area.

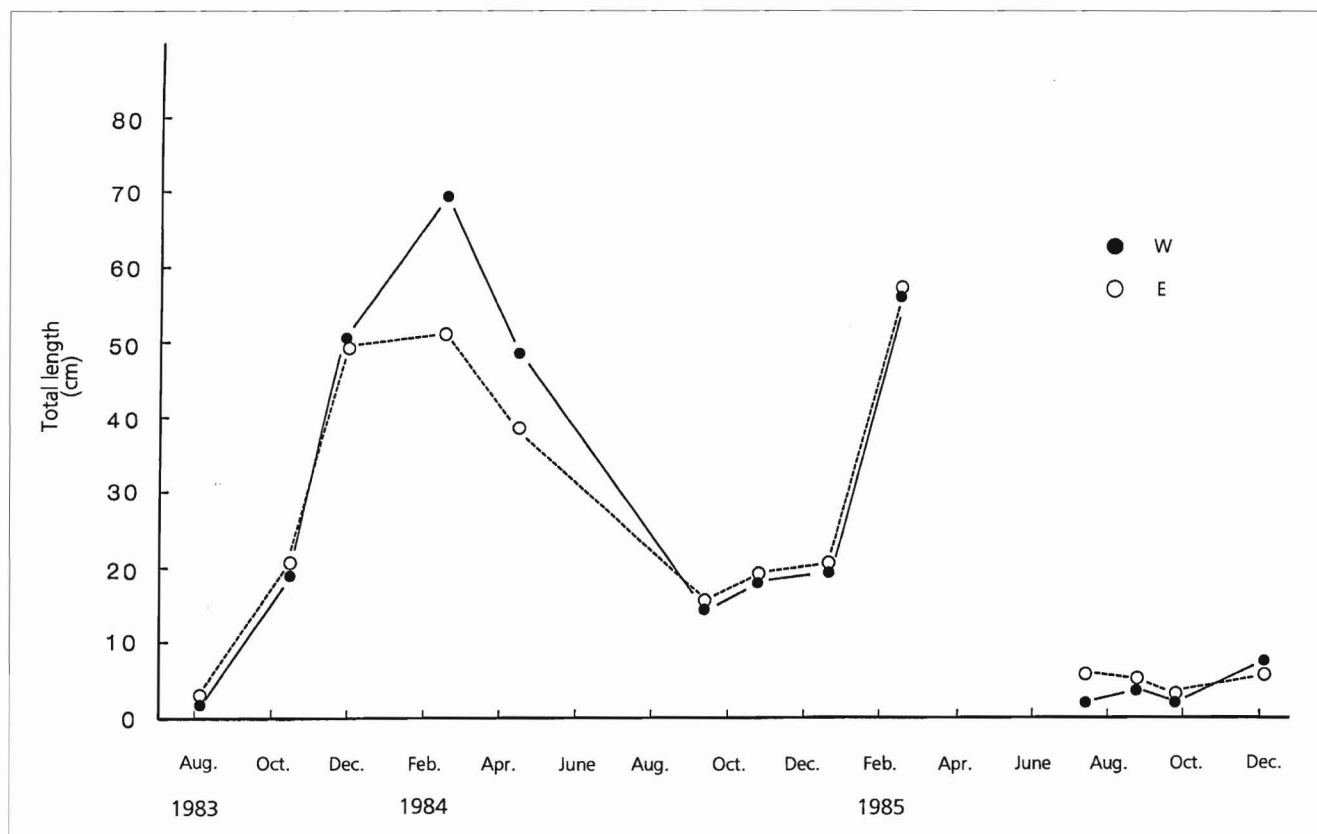


Figure 8

Seasonal variations in total length of *Sargassum patens* (Yoshikawa and Tsukidate 1986). ● = western zone of the study area; ○ = eastern zone of the study area.

*S. piluliferum* and *S. patens* to the invading seaweeds (Komoto et al. 1987, 1988). *S. piluliferum* accounted for 77.6%–86.2% of all seaweeds in the first and second years and then dropped to 47.9% in the third year with the invasion of other seaweeds. Therefore, the forests were not solely composed of *Sargassum* but also of other seaweeds by the third year. Among the other seaweeds, *Ecklonia cava* first appeared in the second year, joined by *Padina arborescens* and *Hypnea charoides*, all of which grew profusely during the third year.

The natural vegetation of *Sargassum* spp. on the artificial reefs was surveyed during culture of the two species on the nonseeded control blocks (Fig. 10). As seen in Figure 13, *S. horneri* was the prevailing species on the control reefs the first year, probably because it matures earlier than any other species and grows fast (Komoto et al. 1987, 1988). The following year, *S. tortile* grew vigorously and became dominant. *S. micracanthum* also grew markedly in the second and third years. It is assumed that the annual *Sargassum* spp. settle first followed by the perennial ones.

## Conclusion

*Sargassum* forests were created and maintained in an experimental area using artificially prepared reefs with seeded string for at least two years using both mono- and multi-species cultures. However, in the third year the forests diminished and were overcome by the invasion of other seaweeds. Therefore, more seedlings must be added in the third year and other seaweeds eliminated in order to maintain *Sargassum* forests for a longer time. Only a small amount of grazing by herbivores was observed in the Seto Inland Sea. This is thought to be one of the reasons why we succeeded in forming *Sargassum* forests.

## Citations

- Arasaki, S.  
 1984. Seaweed forests in Japan. In Moba and Marine organisms (T. Hisamune, ed.), p. 1–11. Report of Japan Fisheries Resources Conservation Association, Zenkoku Choson Kaikan, 11–35, Nagatacho 1, Chiyoda-Ku, Tokyo 100.

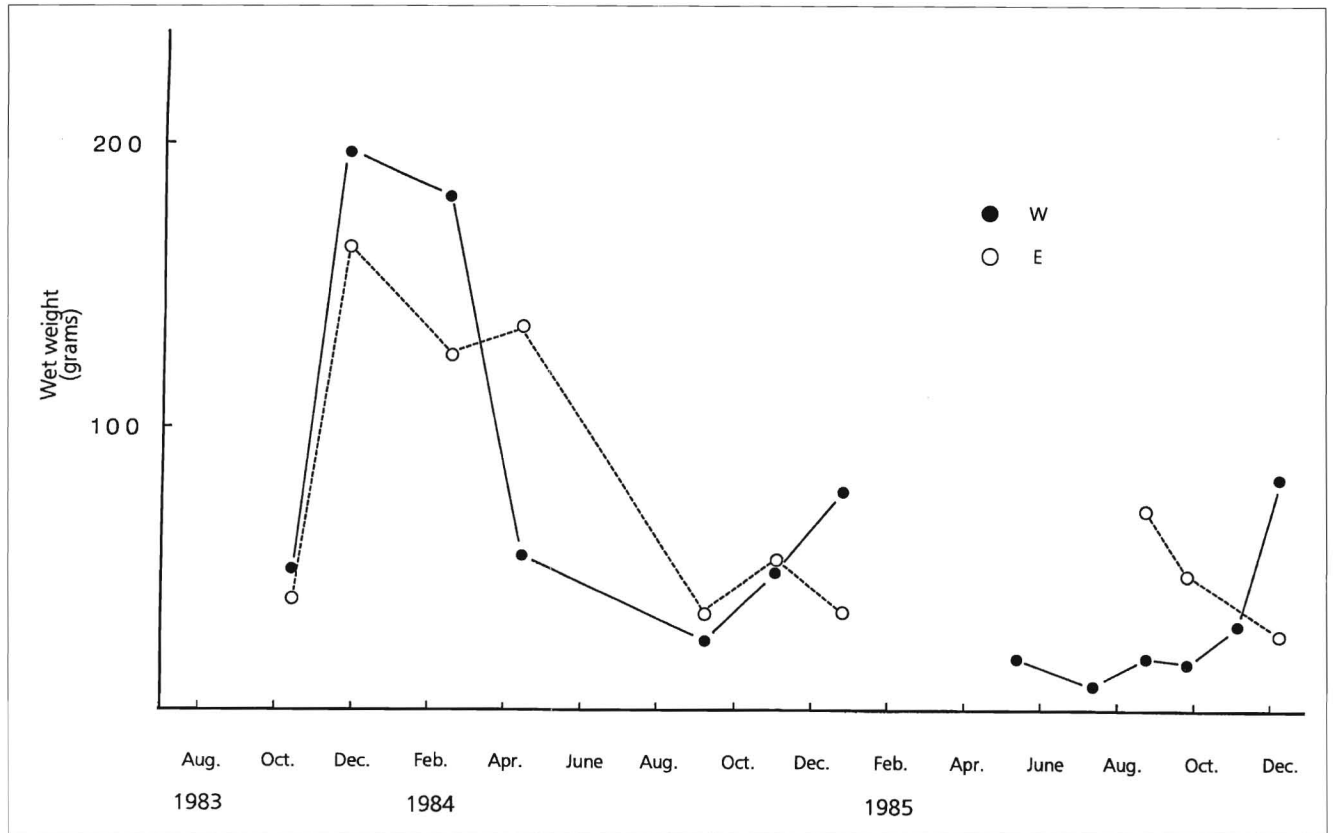


Figure 9

Seasonal variations in wet weight of *Sargassum patens* (Yoshikawa and Tsukidate 1986). ● = western zone of the study area; ○ = eastern zone of the study area.

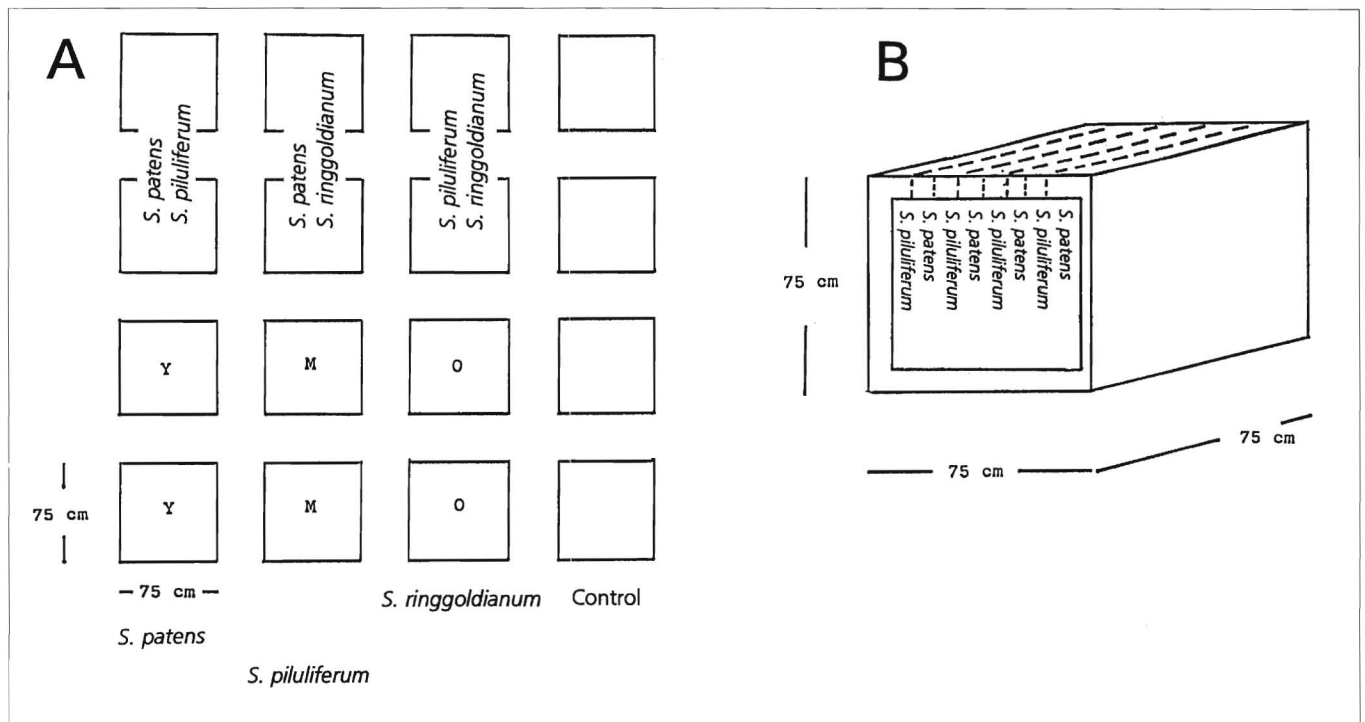
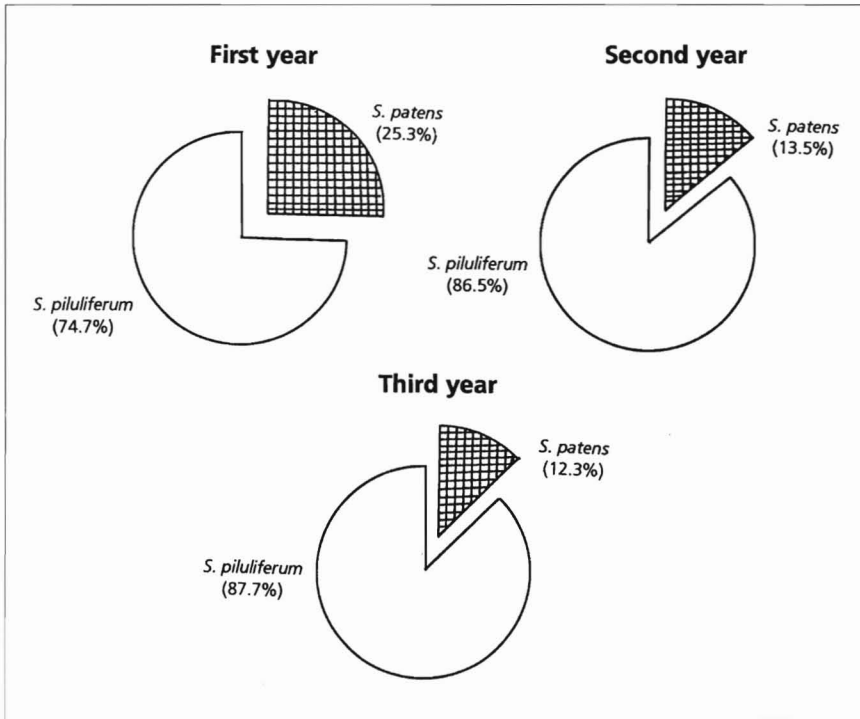
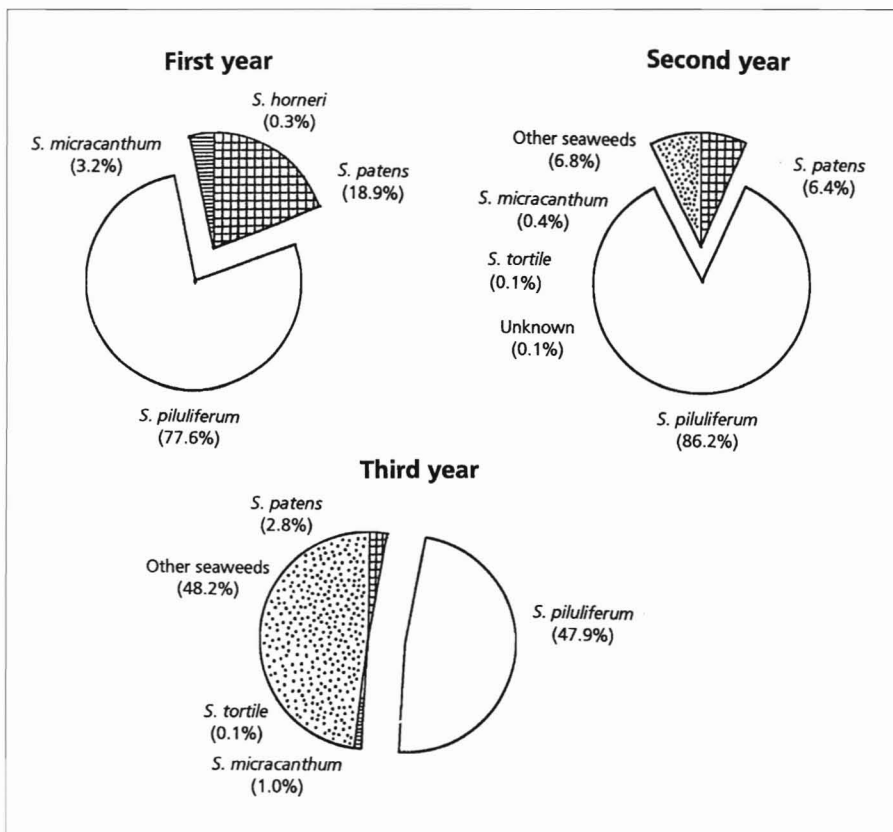


Figure 10

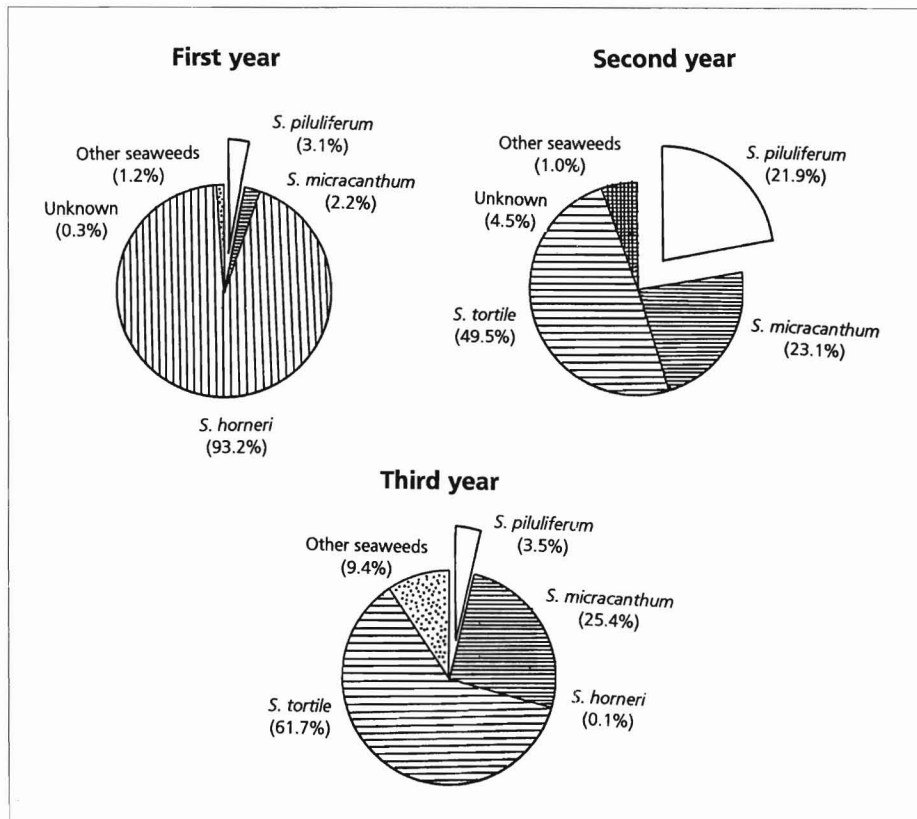
A schematic diagram of artificial reefs for growing *Sargassum* spp. off Yashiro Island, Seto Inland Sea (Komoto et al. 1987). Blocks were planted with seeded strings as follows: Y = *S. Patens*; M = *S. piluliferum*; O = *S. ringgoldianum*; C = no seeded string. Blocks with mixed species were arranged within the reef as shown in (A) and wrapped with alternating strings of each species as shown in (B).



**Figure 11**  
Comparison of *Sargassum patens* to *S. piluliferum* (in percent wet weight) on an artificial reef (Komoto et al. 1988).



**Figure 12**  
Comparison of *Sargassum patens* to *S. piluliferum* to other *Sargassum* spp. (in percent wet weight) on an artificial reef. (Komoto et al. 1987, 1988).

**Figure 13**

Comparison among *Sargassum* spp. (in percent wet weight) on an artificial reef. (Komoto et al. 1987, 1988).

Komoto, Y, T. Iwamoto, and H. Matsuura.

1987. Studies on the control of *Sargassum* forests. Report of Marine Ranching Program, Nansei Natl. Fish. Res. Inst., Hiroshima, p. 17-33. (In Japanese.)

1988. Studies on the control of *Sargassum* forests. Report of Marine Ranching Program, Nansei Natl. Fish. Res. Inst., Hiroshima, p. 23-42. (In Japanese.)

Nakahisa, Y., and H. Kojima.

1982. Ecology of *Sargassum ringgoldianum* and *S. giganteifolium*. Report of Marine Ranching Program, Nansei Natl. Fish. Res. Inst., Hiroshima, p. 71-85. (In Japanese.)

Nakahisa, Y., H. Kojima, and N. Tanimoto

1983. Ecology of *Sargassum ringgoldianum* and *S. giganteifolium*. Report of Marine Ranching Program, Nansei Natl. Fish. Res. Inst., Hiroshima, p. 99-115. (In Japanese.)

Okuda, T.

1981. Settlement mechanisms on the embryo of Sargassaceae. Report of Marine Ranching Program, Nansei Natl. Fish. Res. Inst., Hiroshima, p. 105-117. (In Japanese.)

1982. Settlement mechanisms on the embryo of Sargas-

saceae. Report of Marine Ranching Program, Nansei Natl. Fish. Res. Inst., Hiroshima, p. 101-110. (In Japanese.)

Takaba, M., and A. Mizogami

1982. Seasonal fluctuation of *Sargassum* communities and vertical distribution of Sargassaceae at Kuroshima Island in the western Akinada. J. Hiroshima-Ken Fish. Exp. Station. 12:33-44.

Takemoto, K., S. Takayama, S. Yoshioka, Y. Komoto, and T. Miyago.

1984. *Sargassum* forest formation by artificially prepared seedlings. Report of Marine Ranching Program, Nansei Natl. Fish. Res. Inst., Hiroshima, p. 51-74. (In Japanese.)

Yoshikawa, K., and J. Tsukidate.

1984. *Sargassum* forest formation by setting artificial reefs. Report of Marine Ranching Program, Nansei Natl. Fish. Res. Inst., Hiroshima, p. 75-89. (In Japanese.)

1985. *Sargassum* forest formation by setting artificial reefs. Report of Marine Ranching Program, Nansei Natl. Fish. Res. Inst., Hiroshima, p. 69-86. (In Japanese.)

1986. *Sargassum* forest formation by settling artificial reefs. Report of Marine Ranching Program, Nansei Natl. Fish. Res. Inst., Hiroshima, p. 55-70. (In Japanese.)



# Salmon Gonadotropins

PENNY SWANSON

*School of Fisheries  
University of Washington  
Seattle, WA 98195<sup>1</sup>*

## ABSTRACT

Control of gonadal function by pituitary gonadotropins (GTHs) is a general feature of vertebrate reproduction. In most tetrapods, gonadal function has long been known to be regulated by two GTHs: follicle-stimulating hormone (FSH) and luteinizing hormone (LH) (Licht et al. 1977). Luteinizing hormone, follicle-stimulating hormone, and a third pituitary hormone, thyroid-stimulating hormone (TSH), are chemically related. All three consist of an  $\alpha$  and  $\beta$  subunit, which interact noncovalently and are both glycosylated. In mammals it has been found that the  $\alpha$  subunits of TSH, LH, and FSH are identical within a species, whereas the  $\beta$  subunits are hormone specific and structurally conserved between species (Pierce and Parsons 1981).

The question of whether fish reproduction is regulated by one or two pituitary GTHs has been controversial for nearly two decades. A single GTH, sometimes referred to as maturational GTH, has been isolated from several teleost species: chinook salmon, *Oncorhynchus tshawytscha* (Breton et al. 1978); common carp, *Cyprinus carpio* (Burzawa-Gerard 1971); silver carp, *Hypophthalmichthys molitrix* (Chang et al. 1988a, 1990); pike eel, *Muraenesox cinereus* (Huang et al. 1981; Liu et al. 1989); tilapia, *Oreochromis mossambica* (Farmer and Papkoff 1977); African catfish, *Clarias gariepinus* (Goos et al. 1986); and Atlantic croaker, *Micropogonias undulatus* (Copeland and Thomas 1989). Maturational GTH has been thought to regulate all aspects of gametogenesis (see Burzawa-Gerard 1982; Fontaine and Dufour 1987). The single type of GTH which has been consistently isolated from the teleost species so far examined, appears to be chemically related to tetrapod FSH and LH because of its glycoproteic and subunit nature. In contrast, Idler and colleagues (see Idler and Ng 1983) prepared two GTH fractions from pituitaries of four teleost species; one adsorbed to Concanavalin-A Sepharose and stimulated gonadal steroidogenesis (Con A II) while the other did not adsorb to Concanavalin-A Sepharose and stimulated in vivo vitellogenin uptake by ovarian follicles (Con A I). Con A II shows some chemical similarity to classic tetrapod pituitary GTHs, whereas Con A I does not; Con A I is low in carbohydrate content, and its subunit nature has not been demonstrated.

More recently two pituitary GTHs, GTH I and GTH II, which are distinctly different from each other in chemical characteristics and structurally homologous to tetrapod FSH and LH, have been isolated from chum salmon (*Oncorhynchus keta*) (Kawauchi et al. 1989; Suzuki et al. 1988 a,b; Itoh et al. 1988) and coho salmon (*O. kisutch*) (Swanson et al. 1991). Chum salmon GTH I  $\beta$  and GTH II  $\beta$  subunits have only about 31% amino acid sequence identity to each other. Amino acid sequence comparisons of the chum salmon GTH  $\beta$  subunits to those of bovine FSH (bFSH) and bovine LH (bLH) revealed that the GTH I  $\beta$  subunit has slightly greater sequence identity to the bFSH  $\beta$  subunit (41%) than to the bLH  $\beta$  subunit (35%), whereas the GTH II  $\beta$  subunit has greater identity to the bLH  $\beta$  subunit (42%) than to the bFSH  $\beta$  subunit (38%). Comparisons of the cDNA sequences of the chum salmon GTH  $\beta$  subunits to the cDNAs of the bLH  $\beta$  and bFSH  $\beta$  subunits demonstrate the same structural relatedness (Sekine et al. 1989). The amino

<sup>1</sup> Present address: School of Fisheries, University of Washington, Seattle, WA 98195 and Northwest Fisheries Science Center, National Marine Fisheries Service, 2725 Montlake Blvd. E., Seattle, WA 98112.

acid sequences of chinook salmon (Trinh et al. 1986), common carp (Chang et al. 1988b), silver carp (Chang et al. 1990), and pike eel GTH  $\beta$  subunits (Liu et al. 1989) show about 40% sequence homology to mammalian LH  $\beta$  subunits, and about 75% sequence identity to the chum salmon GTH II  $\beta$  subunit. Therefore, it is apparent that both GTH I and GTH II have structural homology to tetrapod FSH and LH, and the single GTH molecule previously isolated from several teleost species is structurally similar to chum salmon GTH II. GTH I had not been identified in previous studies.

The physiological distinction between GTH I and GTH II is not as clear as the chemical distinction. Studies done to date so far indicate that GTH I and GTH II can stimulate gonadal steroidogenesis. Suzuki et al. (1988c) found that chum salmon GTH I and GTH II were equally potent in stimulating in vitro estradiol 17- $\beta$  production by vitellogenic amago salmon (*O. rhodurus*) ovarian follicles. However, chum salmon GTH II was found to be two times more potent than chum salmon GTH I in stimulating 17 $\alpha$ -hydroxyprogesterone production by ovarian thecal layers and 17 $\alpha$ ,20 $\beta$ -dihydroxy-4-pregnen-3-one production by granulosa layers in the presence of 17 $\alpha$ -hydroxyprogesterone (Suzuki et al. 1988c). Coho salmon GTH I and GTH II stimulated in vitro estradiol 17- $\beta$  and total androgen production by juvenile coho salmon ovarian and testicular tissue, respectively, in a similar dose-dependent manner (Swanson et al. 1989). In recent studies using in vitro incubations of coho salmon testicular fragments, it was found that coho salmon GTH I and GTH II were equipotent in stimulating 11-ketotestosterone secretion (J. Planas, School of Fisheries, Univ. of Washington, Seattle, WA, pers. commun. September 1989). The only clear difference between the biological activities of GTH I and GTH II was the GTH I stimulation of vitellogenin uptake by rainbow trout (*O. mykiss*) oocytes both in vivo and in vitro (Tyler et al. 1991). In the in vitro studies by Tyler and colleagues, GTH I was roughly 100-times more potent than GTH II whereas in vivo GTH II was not active compared to GTH I, which doubled the rate of vitellogenin uptake. Distinctly different actions of GTH I and GTH II in male salmon have not been found and should be the subject of future investigations.

Although salmon GTH I and GTH II appear to have similar steroidogenic activities when tested in vitro, blood and pituitary levels of these two GTHs vary significantly during reproductive development. GTH I was the predominate GTH in the plasma and pituitary of vitellogenic/spermatogenic rainbow trout, whereas GTH II was the predominant GTH at the time of final reproductive maturation (Suzuki et al. 1988d). Swanson et al. (1989) found that in prespermatogenic and previtellogenic (prepubertal) coho salmon, GTH I was the only GTH detectable in the plasma. Recent analysis of plasma levels of GTH I and GTH II in coho salmon during the final year of reproductive maturation have shown an extended increase in GTH I from May through October during vitellogenesis/spermatogenesis, and a decline at the time of spawning (late November or early December). On the other hand, plasma GTH II levels were consistently at low or nondetectable levels throughout vitellogenesis/spermatogenesis, and increased dramatically at the time of spawning (Swanson et al. unpublished). Therefore, the physiological relevance of the steroidogenic activity of GTH II in prepubertal or even vitellogenic/spermatogenic coho salmon is questionable since it does not appear to be present in significant levels in the plasma during this time.

Immunocytochemical studies of salmonid pituitary gonadotrophs have revealed a lack of co-localization of the two GTHs; this is contrary to what has been found for LH and FSH in tetrapods. Nozaki et al. (1990a) demonstrated that antisera directed against coho salmon GTH I  $\beta$  and GTH II  $\beta$  subunits stain two distinctly different gonadotroph cell-types in the pars distalis of salmonids and do not stain thyrotrophs, sommatotrophs, lactotrophs, corticotrophs, or melanotrophs. Moreover, in an ontogenetic study of rainbow trout pituitary gonadotrophs, Nozaki et al. (1990b) showed that GTH I-producing cells are present prior to puberty and increase in number during vitellogenesis; GTH II-producing cells do not appear until after the onset of spermatogenesis/ vitellogenesis and are greater in number than GTH I-producing cells at the time of final reproductive maturation. These data, in addition to data on blood levels of GTH I and GTH II, suggest relationships of GTH I with gonadal growth and GTH II with final maturation of the gonads similar to those of FSH and LH in mammals. More detailed investigations of the specific roles of GTH I and GTH II in salmonid reproductive development are necessary to determine the physiological importance of the dual gonadotropin system in fish.

## Citations

- Breton B., P. Purnet, P. Reinaud  
1978. Sexual differences in salmon gonadotropin. *Ann. Biol. Anim. Biochim. Biophys.* 18:739-765.
- Burzawa-Gerard E.  
1971. Purification d'une hormone gonadotrope hypophysaire de poisson téléostéen, la Carpe (*Cyprinus carpio* L.). *Biochimie (Paris)* 53:545-552.  
1982. Chemical data on the pituitary gonadotropins and their implication to evolution. *Can. J. Fish. Aquat. Sci.* 39:80-91.
- Chang Y.S., F.L. Huang, C.T. Chen, T.B. Lo  
1988a. Isolation and properties of the pituitary gonadotropin from silver carp (*Hypophthalmichthys molitrix*). *Int. J. Pept. Protein Res.* 31:150-156.  
1988b. The primary structures of carp gonadotropin subunits deduced from cDNA nucleotide sequences. *Int. J. Pept. Protein Res.* 32:556-564.
- Chang Y.S., C.J. Huang, F.L. Huang, C.S. Liu, T.B. Lo  
1990. Purification, characterization, and molecular cloning of gonadotropin subunits of silver carp (*Hypophthalmichthys molitrix*). *Gen Comp. Endocrinol.* 78:23-33.
- Copeland P.A., P. Thomas  
1989. Purification of maturational gonadotropin from Atlantic croaker (*Micropogonias undulatus*) and development of a homologous radioimmunoassay. *Gen. Comp. Endocrinol.* 73:425-441.
- Farmer S.W., H. Papkoff  
1977. A teleost (*Tilapia mossambica*) gonadotropin that resembles luteinizing hormone. *Life Sci.* 20:1227-1232.
- Fontaine Y.A., S. Dufour  
1987. Current status of LH-FSH-like gonadotropin in fish. *In Proceedings of the third international symposium on reproductive physiology of fish* (D.R. Idler, L.W. Crim, and J.W. Walsh, eds.) p. 48-56. Memorial Univ. Newfoundland, St. John's Newfoundland, Canada.
- Goos H.J.T., R. De Leeuw, E. Burzawa-Gerard, M. Terlouw, C.J.J. Richter  
1986. Purification of gonadotropic hormone from the pituitary of the African catfish, *Clarias gariepinus* (Burchell), and development of a homologous radioimmunoassay. *Gen. Comp. Endocrinol.* 63:162-170.
- Huang, F.L., C.J. Huang, S.H. Lin, T.B. Lo, H. Papkoff  
1981. Isolation and characterization of gonadotropin isohormones from the pituitary gland of pike eel (*Muraenesox cinereus*). *Int. J. Pept. Protein Res.* 18:69-78.
- Idler D.R., T.B. Ng  
1983. Teleost gonadotropins: Isolation, biochemistry and function. *In Fish physiology*, Vol. 9A (W.S. Hoar, D.J. Randall and E.M. Donaldson, eds.), p. 187-221. Acad. Press. NY.
- Itoh H., K. Suzuki, H. Kawauchi  
1988. The complete amino acid sequences of  $\beta$  subunits of two distinct chum salmon GTHs. *Gen. Comp. Endocrinol.* 71:438-451.
- Kawauchi H., K. Suzuki, H. Itoh, P. Swanson, M. Nozaki, N. Naito, Y. Nagahama  
1989. Duality of salmon pituitary gonadotropins. *Fish Physiol. Biochem.* 7:29-38.
- Licht P., H. Papkoff, S.W. Farmer, C.H. Muller, H.K. Tsui, D. Crews  
1977. Evolution of gonadotropins structure and function. *Recent Prog. Horm. Res.* 33:169-248.
- Liu C.S., F.L. Huang, Y.S. Chang, T.B. Lo  
1989. Pike eel (*Muraenesox cinereus*) gonadotropin. Amino acid sequences of both  $\alpha$  and  $\beta$  subunits. *Eur. J. Biochem.* 186:105-114.
- Nozaki M., N. Naito, P. Swanson, K. Miyata, Y. Nakai, Y. Oota, K. Suzuki, H. Kawauchi  
1990a. Salmonid pituitary gonadotrophs I. Distinct cellular distributions of two gonadotropins, GTH I and GTH II. *Gen. Comp. Endocrinol.* 77:348-357.  
1990b. Salmonid pituitary gonadotrophs II. Ontogeny of GTH I and GTH II cells in the rainbow trout (*Salmo gairdneri irideus*). *Gen. Comp. Endocrinol.* 77:358-367.
- Pierce J.G., T.F. Parsons  
1981. Glycoprotein hormones: structure and function. *Ann. Rev. Biochem.* 50:465-495.
- Sekine S., A. Saito, H. Itoh, H. Kawauchi, S. Itoh  
1989. Molecular cloning and sequence analysis of chum salmon gonadotropin cDNAs. *Proc. Nat. Acad. Sci.* 86:8645-8649.
- Suzuki K., H. Kawauchi, Y. Nagahama  
1988a. Isolation and characterization of two distinct gonadotropins from chum salmon pituitary glands. *Gen. Comp. Endocrinol.* 71:292-301.  
1988b. Isolation and characterization of subunits of two distinct gonadotropins from chum salmon pituitary glands. *Gen. Comp. Endocrinol.* 71:302-306.  
1988c. Steroidogenic activities of two distinct salmon gonadotropins. *Gen. Comp. Endocrinol.* 71:452-458.
- Suzuki K., A. Kanamori, H. Kawauchi, Y. Nagahama  
1988d. Development of salmon GTH I and GTH II radioimmunoassays. *Gen. Comp. Endocrinol.* 71:459-467.
- Swanson P., M.G. Bernard, M. Nozaki, K. Suzuki, H. Kawauchi, W.W. Dickhoff  
1989. Gonadotropins I and II in juvenile coho salmon. *Fish Physiol. Biochem.* 7:169-176.
- Swanson P., K. Suzuki, H. Kawauchi, W.W. Dickhoff  
1991. Isolation and characterization of two coho salmon gonadotropins, GTH I and GTH II. *Biol. Reprod.* 44:29-38.
- Trinh K.Y., N.C. Wang, C.L. Hew, L.W. Crim  
1986. Molecular cloning and sequencing of salmon gonadotropin beta subunit. *Eur. J. Biochem.* 159:619-624.
- Tyler C., J.P. Sumpter, H. Kawauchi, P. Swanson  
1991. Involvement of gonadotropin in the uptake of vitellogenin into the vitellogenic oocytes of the rainbow trout, *Oncorhynchus mykiss*. *Gen. Comp. Endocrinol.* 84:291-299.



# Breeding Season of Japanese Scallop off the Eastern Coast of Hokkaido

HIROSHI ITO

*Hokkaido National Fisheries Research Institute*  
(formerly: *Hokkaido Regional Fisheries Research Laboratory*)  
*Fisheries Agency*  
*The Ministry of Agriculture, Forestry and Fisheries*  
116 Katsura-koi, Kushiro City, Hokkaido, 085 JAPAN

## Abstract

The breeding of Japanese scallops, *Patinopecten* (*Mizuhopecten*) *yessoensis*, in coastal beds off east Hokkaido was estimated using a gonadal-somatic index. Although the breeding season differs by locality, it begins when bottom temperatures reach about 5° C in the beds. Therefore the bottom temperature indicates the beginning of scallop breeding.

## Introduction

Mariculture of the Japanese scallop, *Patinopecten* (*Mizuhopecten*) *yessoensis*, developed rapidly in the mid-1960s owing to development of methods for mass seed production using natural spat (Tsubata 1982). After the 1970s, scallop mariculture production rapidly increased, mainly off the coast of Hokkaido in northern Japan (Figs. 1 and 2; Ito 1988). In 1988, Japanese scallop production amounted to 341,618 metric tons. Although the scallop fishery has become a large industry, the reliability of scientific information concerning scallops remains uncertain (Ito 1989).

Japanese scallop mariculture begins with the collection of wild spat. Spat collection relies upon realtime information on the breeding occurrence of scallop breeding: the subsequent larvae reflect the earliest stage of scallop life (Fig. 3: modified from Yamamoto 1964; Maru 1972, 1976, 1978; Osanai 1975; Kawamata et al. 1981). The breeding season of the scallop in various coastal beds has in the past been roughly monitored by coastal fisheries cooperative associations. Results in 1982 are shown in Figure 4 (Ito 1990). Among the scallop culturing areas off Hokkaido, breeding occurred first in the Japan Sea, second in the Okhotsk Sea, and third in the Nemuro Straits. It is thought that a relationship exists between the gonado-somatic index and the surface tempera-

ture, although scallop live on the bottom. Similarly observed results have already been reported (Kinoshita 1934; Yamamoto 1951). At about 8° C surface temperature (Fig. 5), some scallops might begin breeding; however, bottom temperature is not always parallel to that of the surface. Currently, information on breeding is vague, whereas industrial spat collection requires accurate data on the key phenomena. In fact, industrial monitoring methods for wild spat collection are not established even now. Therefore, the author created a special team for this research and surveyed the breeding season, focusing on wild spat collection.

## Materials and Methods

Japanese scallops were collected from three localities in the Nemuro Straits, east Hokkaido (Fig. 6). Depths of survey sites were determined acoustically: 13 m off Rausu, located in the north in the Nemuro Straits; 21 m off Shibetsu in the middle portion of the Nemuro region; and 12 m off Bekkai, which is located in the southern portion of Nemuro Bay. Specimens were sampled every week from a wild population of 4- to 7-year-olds at the site off Rausu by diving, from similar wild population off Shibetsu using a scallop dredge, and from a cultured population of 3-year-olds off Bekkai using a scallop dredge. Water temperature at

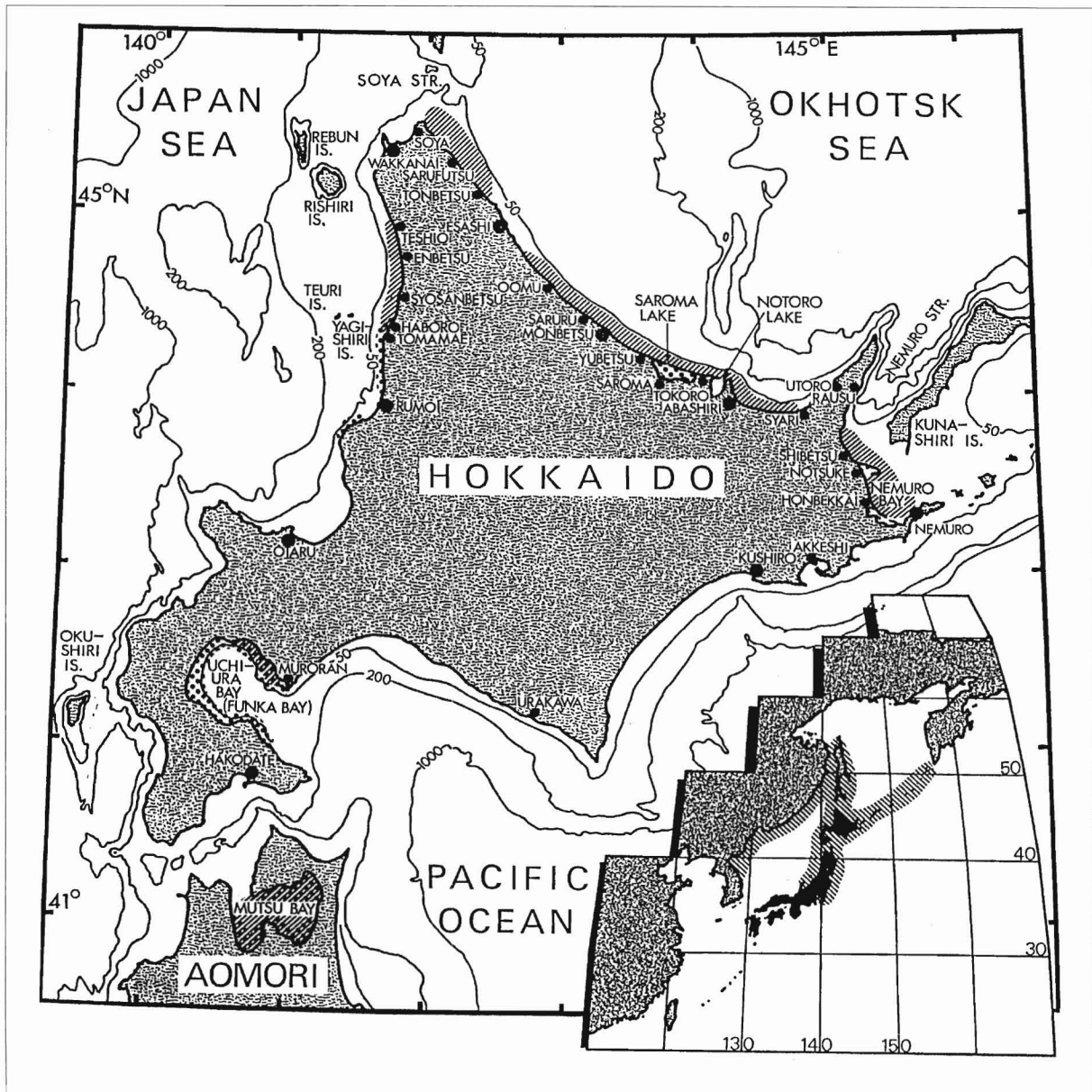


Figure 1

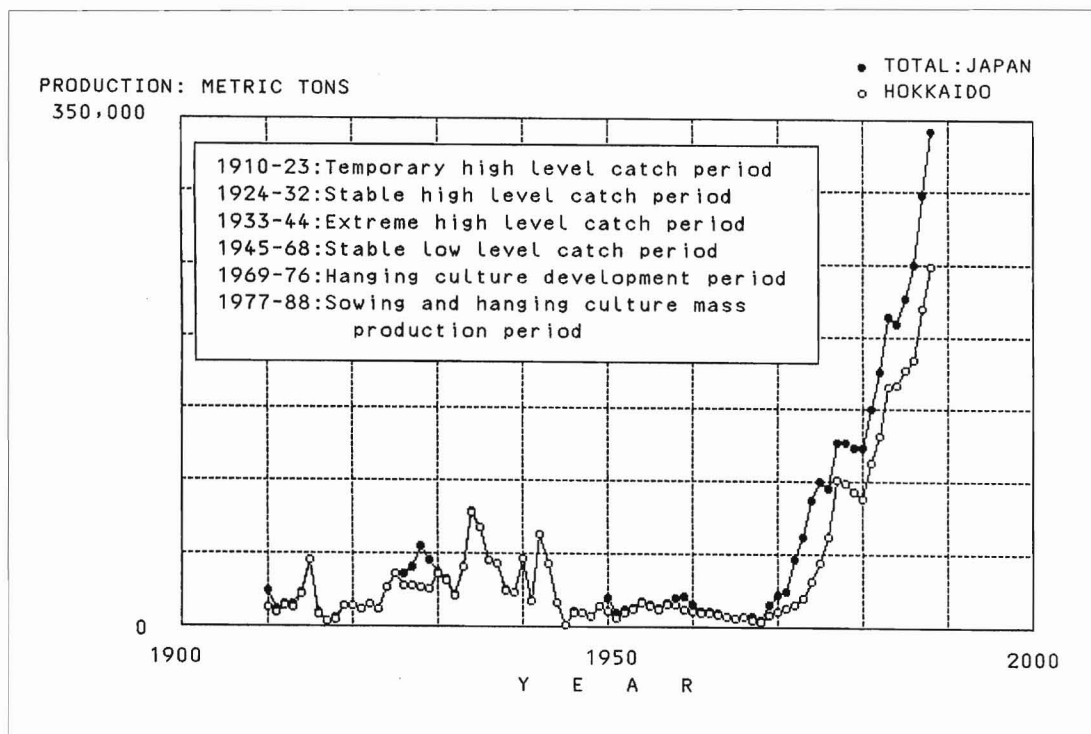
Main mariculture areas in Japan and natural distribution in east Asia of the Japanese scallop, *Patinopecten* (*Mizuhopecten*) *yessoensis*.

every survey time was observed from surface to bottom at intervals of 2 m with the use of a thermometric electrode. This field study began in mid- to late April 1982 at every site and finished in May/July 1982 as breeding was completed at each site. Gonads and soft body tissues were measured by wet weight. The gonado-somatic index was estimated with the following equation.

$$\text{gonado-somatic index} = \frac{\text{gonad weight} \times 100}{\text{soft body weight}}$$

## Results and Discussion

Changes in the gonado-somatic indexes of males and females were nearly synchronized, although details showed they were slightly different (Fig. 7). The index values at each site were lower in April and increased in May. When the index decreased suddenly after reaching a maximum, we estimated that breeding occurred. Using this index, we also estimated that the time of breeding varied by locality. It began in early June off Rausu in the north (Nemuro



**Figure 2**  
Annual production of the Japanese scallop, *Patinopecten (Mizuhopecten) yessoensis*, in Japan, 1910–1988.

Straits), in mid-June off Shibetsu in the middle area, and in mid-May off Bekkai in the southern portion of the Nemuro region. Although the breeding season differs by locality, it begins when the bottom temperature reaches about 5° C in every bed. Therefore, the bottom temperature seems to indicate the beginning of scallop breeding. This is new information on the Japanese scallop. In the past, scallop researchers focused on the midpoint of the breeding season. In this paper the author is proposing a new idea, that earlier generation spat can be of great advantage to the scallop mariculture industry. Earlier generation spat grow to a larger size than those collected later. The larger scallop also market at a better price. So, knowledge of the beginning of the breeding season is beneficial information. In addition, the author suggests that research focus on new concepts (Ito 1989) for scallop mariculture which includes an examination of the biology of breeding.

### Acknowledgments

The author wishes to express sincere thanks to the following co-workers of the research team: Toshikazu Fujimoto, Takao Sasaki, Haruo Moriya, Tohru Ikeda, Tadashi Abe, Yukiyasu Nakata, and Yoshiji Kobayashi for their expertise and friendship.

### Citations

- Ito, H.  
1988. Sowing culture of scallop in Japan. *In* New and innovative advances in biology/engineering with potential for use in aquaculture: proceedings of the fourteenth U.S.-Japan meeting on aquaculture (A.K. Sparks, ed.), p. 63–69. NOAA Tech. Rep. NMFS 70.  
1989. Concept in mariculture of Japanese scallop. *Scallop (2)*, Hotatekai (Kushiro), p. 89–97. (In Japanese.)  
1990. Some aspects of offshore spat collection of Japanese scallop. *In* Marine farming and enhancement: proceedings of the fifteenth U.S.-Japan meeting on aquaculture (A.K. Sparks, ed.), p. 35–48. NOAA Tech. Rep. NMFS 85.
- Kawamata, K., Y. Tamaoki and A. Fuji.  
1981. Gonad development of the cultured scallops in Funka Bay. *J. Hokkaido Fish. Exp. Stn. (Hokusuisi Geppo)* 38:132–146. (In Japanese.)
- Kinoshita, T.  
1934. Relation between breeding of the Japanese scallop and water temperature. Report of the Hokkaido Fish. Res. Stn. (Hokusuisi Junpo) 233:3–8. (In Japanese.)
- Maru, K.  
1972. Morphological observations on the veliger larvae of a scallop, *Patinopecten yessoensis* (Jay). *Sci. Rep. Hokkaido Fish. Exp. Stn.* 14:55–62. (In Japanese, English abstr.)  
1976. Studies on the reproduction of a scallop, *Patinopecten yessoensis* (Jay)-1. Reproductive cycle of the cultured scallop. *Sci. Rep. Hokkaido Fish. Exp. Stn.* 18:9–26. (In Japanese, English abstr.)  
1978. Studies on the reproduction of a scallop, *Patinopecten yessoensis* (Jay)-2. Gonad development in 1-year-old scallops. *Sci. Rep. Hokkaido Fish. Exp. Stn.* 20:13–26. (In Japanese, English abstr.)

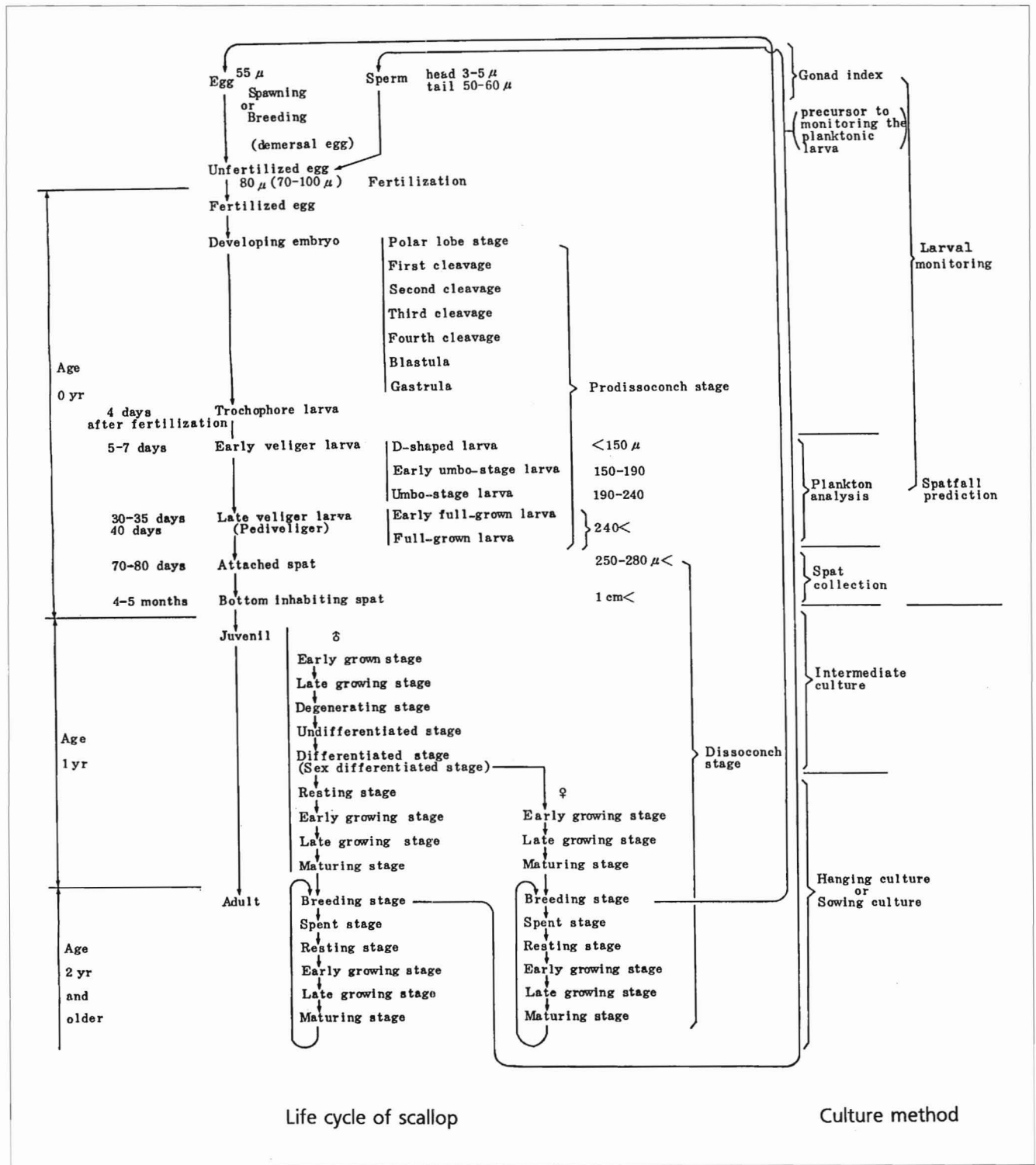
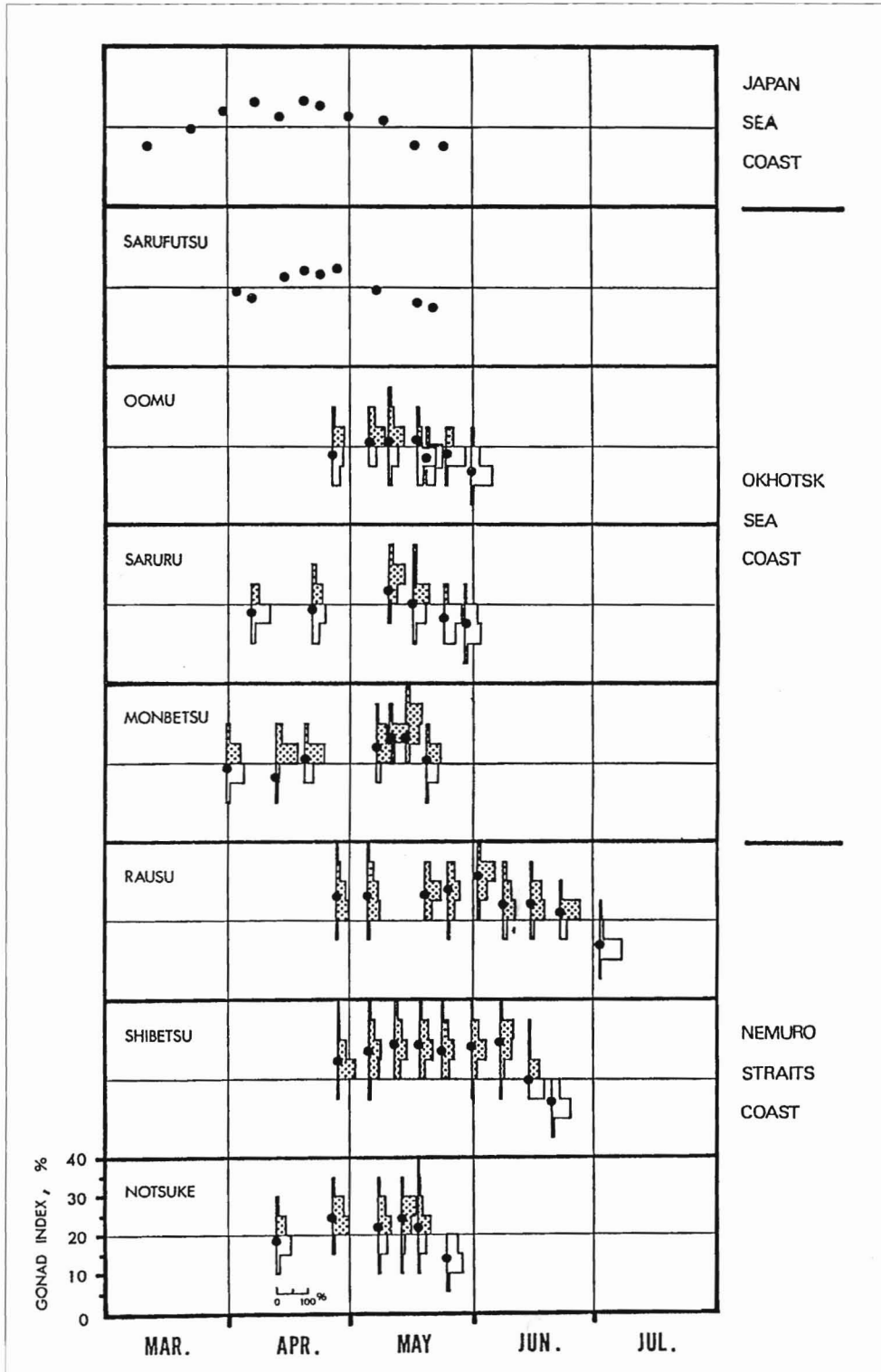


Figure 3

Life cycle of the Japanese scallop, *Patinopecten (Mizuhopecten) yessoensis*, with the note of culture methods (modified from Yamamoto 1964; Maru 1972, 1976, 1978; Osanai 1975; Kawamata et al. 1981).





**Figure 4**  
Changes in gonado-somatic index (gonad weight  $\times$  100/soft body weight, %) of the Japanese scallop, *Patinopecten (Mizuhopecten) yessoensis*, off the coasts of Hokkaido, 1982. Specimens were mainly 3- and 4-year-olds (Ito 1990).

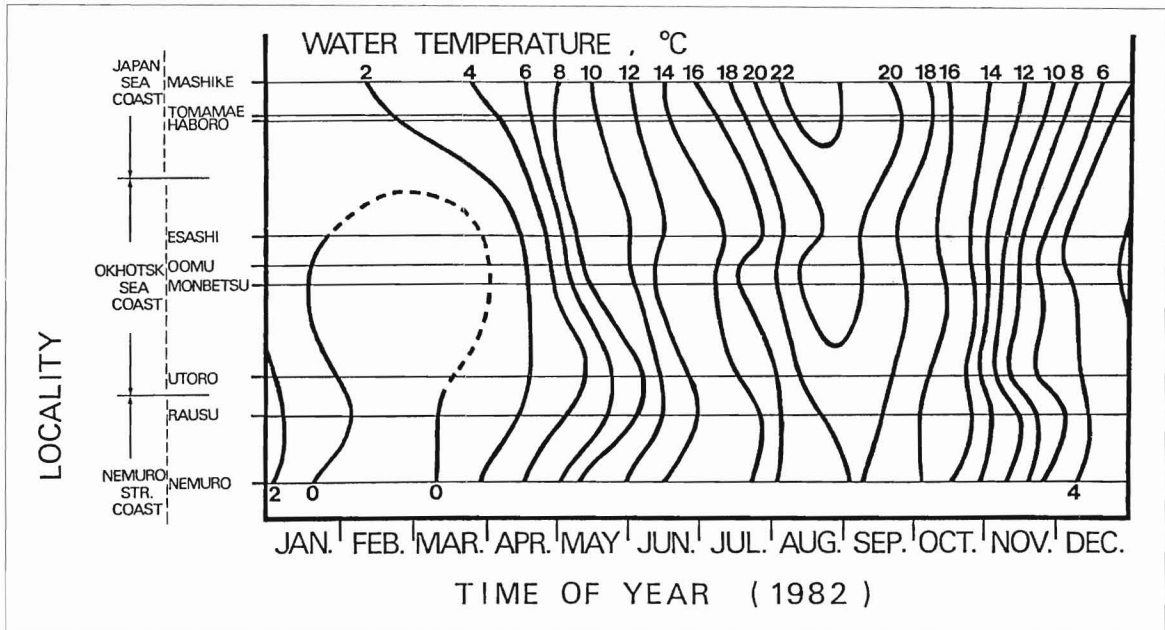


Figure 5

Changes in surface temperature of the coastal water related with the locality of Hokkaido in 1982 (Ito 1990).

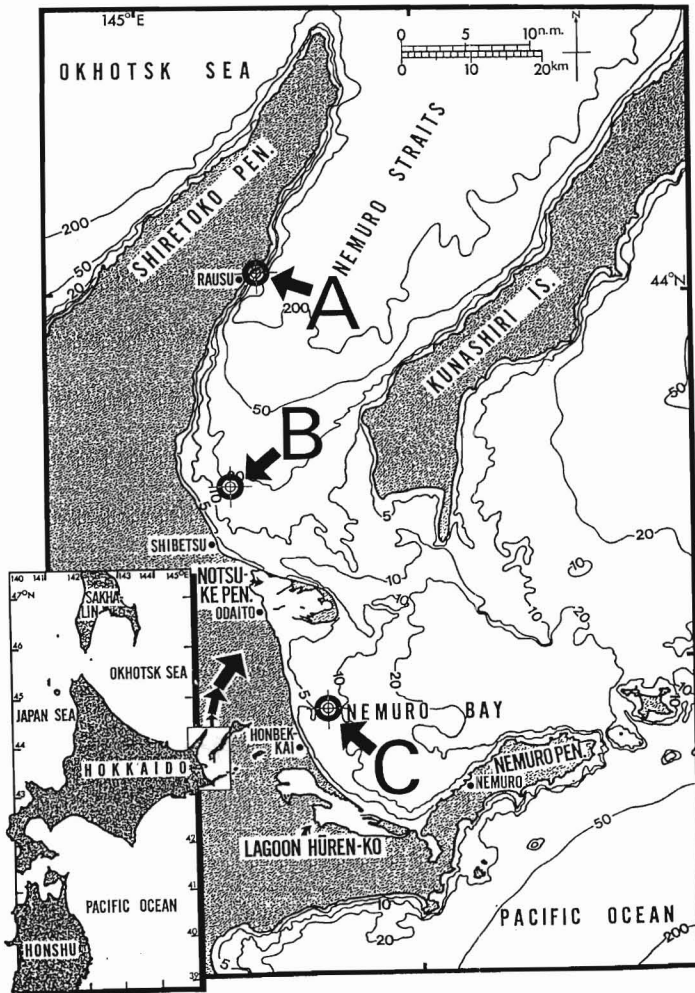


Figure 6

Survey sites (A, B, C) in Nemuro Straits, east Hokkaido. A = site off Rausu. B = site off Shibetsu. C = site off Bekkai.

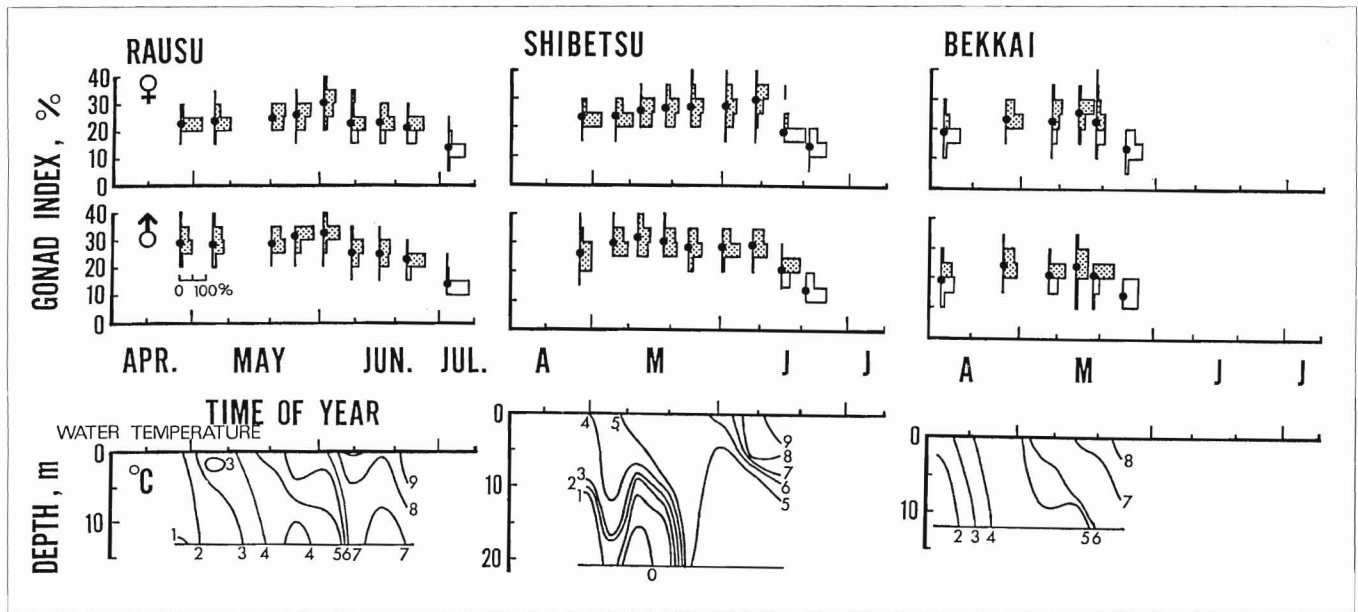


Figure 7

Changes in the gonado-somatic index of Japanese scallops, *Patinopecten (Mizuhopecten) yessoensis*, and the water temperature in Nemuro Straits, 1982 (Ito 1990).

Osanai, K.

1975. Seasonal gonad development and sex alteration in the scallop, *Patinopecten yessoensis*. Bull. Mar. Biol. Stn. Asamushi. Tohoku Univ. 15(2):81-88.

Tsubata, F.

1982. A history of the fisheries researches of the scallop, *Patinopecten yessoensis*, in Mutsu Bay. Published by Aomori Prefecture (Aomori Prefecture government publication), 120 p. (In Japanese.)

Yamamoto, G.

1951. Ecological study on the spawning of the scallop, *Pecten (Patinopecten) yessoensis* in Mutsu Bay. Bull. Japan. Soc. Sci. Fish. 17(2):53-56. (In Japanese, English synop.)

1964. Scallop culture in Mutsu Bay. Suisan Zoyoshoku Sosho (Aquaculture series in fisheries) 6 (Tokyo), 77 p. (In Japanese.)



# A Better Method for Oyster Farming in Japan

TETSUO SEKI

*Oyster Research Institute  
211 Higashi Mohne Karakuwa  
Miyagi 988-05, Japan*

## Abstract

The Japanese oyster farming industry experienced a remarkable change with the development of the raft culturing method. Recently, northern Japanese oyster farmers have been facing difficulty in maintaining the quality of oysters. It was concluded that this problem originated with certain methods utilized by the present oyster farmers of the raft culture system. In order to resolve the problems, new farming practices were developed in which the introduced flat oyster *Ostrea edulis* was used at the Oyster Research Institute. A new cultch-based seed collecting method for single oyster seed production and a multilayered, compact hanging method were devised to better utilize the coastal water column for oyster farming. The recent progress of this strategy is described and discussed.

## Introduction

---

The Oyster Research Institute (ORI), a private non-profit foundation, was established in 1961 at Mohne Bay in Miyagi Prefecture. Funding for the Institute was initially derived from private company sources in Sendai. These companies hoped to redevelop the traditionally important oyster industry in Miyagi Prefecture and to encourage the related studies of Dr. Takeo Imai, a professor at Tohoku University, by establishing an industry-based research laboratory.

The Oyster Research Institute pioneered seed production and farming of the Japanese abalone species *Haliotis discus hannai* (Seki 1980; Seki and Cuthbertson 1988) and the French oyster *Ostrea edulis* (Imai 1967; Imai 1971). The initial aim of introducing French oysters was to establish an exotic oyster industry in Miyagi Prefecture. Although large amounts of French oyster seed were produced, the oysters were not popular with the Japanese consumer. However, recent changes in Japanese eating habits show an increased demand for luxury seafood.

The aim of French oyster research at ORI was targeted at providing innovative alternatives for oyster farmers in northern Japan such as improved technological sophistication and ways to better utilize associated coastal waters.

New methods of collecting and culturing oyster seed were introduced in 1989; this paper describes these developments and discusses the relevant background issues.

## Recent Problems with Oyster Farming in Northern Japan

---

Since 1950, substantial developments in oyster farming in Hiroshima and northeastern Japan have been experienced. These developments are due primarily to the popularity of raft culture and the introduction of long-line systems (Fujiya 1970; Imai 1971; Kafuku and Ikenoue 1983). Despite such developments, the industry now faces a number of problems. The increasing popularity of scallop farming due to its greater returns has stagnated oyster production in many areas. A gradual increase in the average age of oyster farmers together with increasing water pollution in growing areas has further contributed to the decline of the industry.

The introduction of styrofoam flotation to oyster lines gave much greater buoyancy to the system. As a result, farmers tended not to remove fouling organisms such as mussels from the support lines. Rather than removing long lines from the water and drying

out the fouling material, it was found to be much easier to simply lower the system further into the water by adding more line. This treatment leaves the oyster in a cool, dark environment where their food source, phytoplankton, is less abundant. Such a practice occurs despite the fact that the oyster's natural habitat is the brackish intertidal zone where temperatures fluctuate more rapidly and food is more abundant. Failure to remove competitors such as mussels, cionas (sea squirts), and hydroids (tubeworms) further compounds the problem by reducing the amount of food plankton available to the oysters and by restricting light penetration to the deeper zones and thereby reducing phytoplankton reproduction.

As a result of the above situation, culture time is extended beyond one year because of slower growth, which in turn affects the spawning cycle because of a lack in cumulative temperature required for maturation. A deterioration in taste during autumn also occurs as a result of unspawned eggs brought about by a delay in glycogen accumulation. Japanese oysters are gradually losing flavor compared with the same species harvested in other countries where the traditional sowing methods are still applied. The result is a lower price for the local product, which creates further disincentive for Japanese farmers to maintain proper husbandry practices.

Farmed oysters in the coastal water column on the Pacific side of northern Japan now utilize a totally different phytoplankton population and have different, corresponding energy flow dynamics to those harvested prior to the development of oyster culture techniques. The time has arrived for a detailed analysis of current culture practices and a complete reassessment of the direction of oyster culture in the future.

In shallow areas less than 3 m deep, favorable conditions for the culture of oysters can still be found; higher water temperatures and more abundant phytoplankton during spring and autumn are just two of the favorable parameters associated with these types of culture grounds. A decrease in salinity, which occurs during the rainy season, is also an important feature. The culture of oysters in this zone combined with proper practices to control fouling will result in a quality product that is acceptable in the market place.

It may be argued that such a practice will result in lower production; while this may be correct, there will be a corresponding shortening of growing time from 3 to 1.5 years and there is always the prospect of increased prices for a better quality product. Once this is achieved the development of more efficient

farming techniques can be employed to fully utilize the shallow waters.

### French Oyster Farming: Seed Collection and Industry Planning

Rather than attempt to adapt existing techniques, a totally new system was developed for the French oyster industry.

Although French oysters require higher salinity than *Crassostrea gigas*, the new techniques established for French oyster farming can be applied to the euryhaline Japanese oyster.

Improved seed collection technique was the first factor considered because the current system provides extra space for competitors, which by harvest time outweigh the oysters. The low survival rate of attached spat (less than 10%) (Akio Oshino, ORI, pers. commun. Dec. 1988) further contributes to higher levels of fouling organisms. One obvious solution would be to culture oyster seed alone using single oyster collection techniques without substrate. This, however, would require the use of very fine netting to hold an early-stage juvenile and could result in a much worse fouling problem.

The use of crushed mussel shell as a substrate alleviated the above problems. A total of 500 g of shell particles with sizes ranging from 10 to 20 mm were used as substrate. These were spread in a monolayer on 20 plastic trays measuring 352 × 204 × 35 mm. The trays are manufactured to hold small fish for display purposes in supermarkets. The walls and bottom of each tray have 8-mm mesh pores. One set of collectors, consisting of 20 trays, was used to hold approximately 60,000 shell pieces. The 20 trays were tightly stacked and tied with strings, which were set through four corners to form a vertical hanging. A total of 40 collector sets were introduced into a set tank measuring 2.0 × 1.5 × 1.0 m. Along with the collectors, approximately 1.5 million competent larvae were introduced with an attachment rate of two seed per piece of shell. During two days of settling time, the water temperature was maintained at 20° C with an electric heater and aeration. Approximately 600,000 French oyster seed of 20-mm size were collected in this manner in 1989. The survival rate with this method was much higher and fouling was considerably less compared with the earlier use of scallop shell (Oshino and Seki, unpubl. data). Thinning of seeds in the trays was not required until the fourth month when sorting was also undertaken. Fouling control was achieved by soaking the seeds in 9% sodium chloride enriched seawater once at a month for

10 minutes (Oshino and Seki, unpubl. data). The seed production rate using this method was 14.8% compared with 8.7% with the previous scallop cultch method. Further work needs to be done to determine the optimal timing for removal of fouling organisms, the best growing densities, and the associated labor requirements.

Consideration needs to be given to better hanging techniques that would lead to better yields and lower labor costs. Current raft licensing and associated culture densities are controlled by the relevant fisheries cooperatives in each farming area. The Karakuwa fisheries cooperative, which controls rafts adjacent to ORI, allow 180 hanging lines to each raft; raft size is limited to  $5.4 \times 9$  m. The length of each culture line is variable dependent on water depth. From the above information it is estimated that a combination of 200 oysters and associated fouling organisms occur in each cubic meter of the water column. Clearly, if the existing planktonic food was available only to the oyster cultures, the total biomass of the culture could be greatly increased. Because culturing space is at a premium, it appears logical that greater production can only be achieved through better utilization of the water column.

For example, each oyster farmer can expect a return of 600,000 yen or \$4,138 from each raft in the third year of production assuming 24,000 oysters/raft. This equates to an annual gross income of 200,000 yen, or \$1,379/raft. With an average raft number per farmer in northern Japan of 20, it can be seen that the annual income from oyster farming is not sufficient to sustain a farmer and his family. This current situation can be overcome by starting a program to educate farmers in the improved practices previously mentioned.

Among the commercially manufactured containers, plastic trays with a 9-mm mesh size are the best available to hold oysters economically. Each  $705 \times 462 \times 57$  mm container can hold 50 adult oysters and a string of 10 containers can house 500. Thus, the same raft area in the same depth of water column can house about 70,000 oysters. The smaller size of the hanging medium allows for more efficient handling in terms of fouling control. Currently, work is underway to determine such parameters as the optimum fouling control immersion period and the use of aeration to maintain adequate water movement.

In summary, Japanese consumers are appreciating more exotic, rare, and higher quality seafoods such as the French oyster—even the price is higher (the higher price received for French oysters together with the advanced growing system is a means to attract existing farmers into the redevelopment of the Japanese oyster industry). If the existing oyster industry is to survive and prosper, it must react to changes in market forces. The development of the French oyster, together with associated advanced culture techniques, is one such example of the need for change in the existing industry.

Biological developments, such as triploid oysters, are less practical in Japan because of the seasonal tastes of the Japanese people. It is more likely that biological advances will result in environmental enhancement. It is absolutely vital that increased effort be placed in the area of water quality improvement in order to prevent the contamination of oyster farming grounds and to maintain a safe, clean environment for further development of the Japanese oyster industry.

## Citations

- Fujiya, M.  
1970. Oyster farming in Japan. *Helgol. Wiss, Meeresunters*, 20:464–479.
- Imai, T.  
1967. Mass production of molluscs by means of rearing the larvae in tanks. *Venus Jpn. J. Malacol.*, 25:159–167.  
1971. Through culture and its advance. *Koseisha-Koseikaku*, Tokyo, 454 p. (In Japanese.)
- Kafuku, T., and H. Ikenoue.  
1983. Modern methods of aquaculture in Japan. *Developments in aquaculture and fisheries science*, Vol. 11. Kodansha Ltd., Tokyo and Elsevier Scientific Publ. Co., Amsterdam, 216 p.
- Seki, T.  
1980. An advanced biological engineering system for abalone seed production. *In Int. symp. coastal Pacific marine life*; 15–16 October 1979, Bellingham, WA, p. 45–54. Avail. from Library, W. Wash. State Univ., Bellingham, WA 98225.
- Seki, T. and A.S. Cuthbertson.  
1988. Recent advances in abalone culture. *In Proceedings for the Aquaculture International Congress and Exposition*, Vancouver Trade & Convention Center, Vancouver, B.C.; 6–9 September, 1988, Vancouver, Canada, p. 377–384. (Avail.) *Aquacult. Int. Cong. British Columbia Pavilion Corporation Box 31, 770 Pacific Blvd. South Vancouver, B.C., Canada.*





# Hormonal Regulation of Reproduction in Female Crustacea

HANS LAUFER and ELLEN HOMOLA

*University of Connecticut  
Department of Molecular and Cell Biology  
Storrs, CT 06269-3125*

*and*

*The Marine Biological Laboratory  
Woods Hole, MA 02543 U.S.A.*

MATTHEW LANDAU

*Department of Marine Science  
Stockton State College  
Pomona, N.J. 08240*

## Abstract

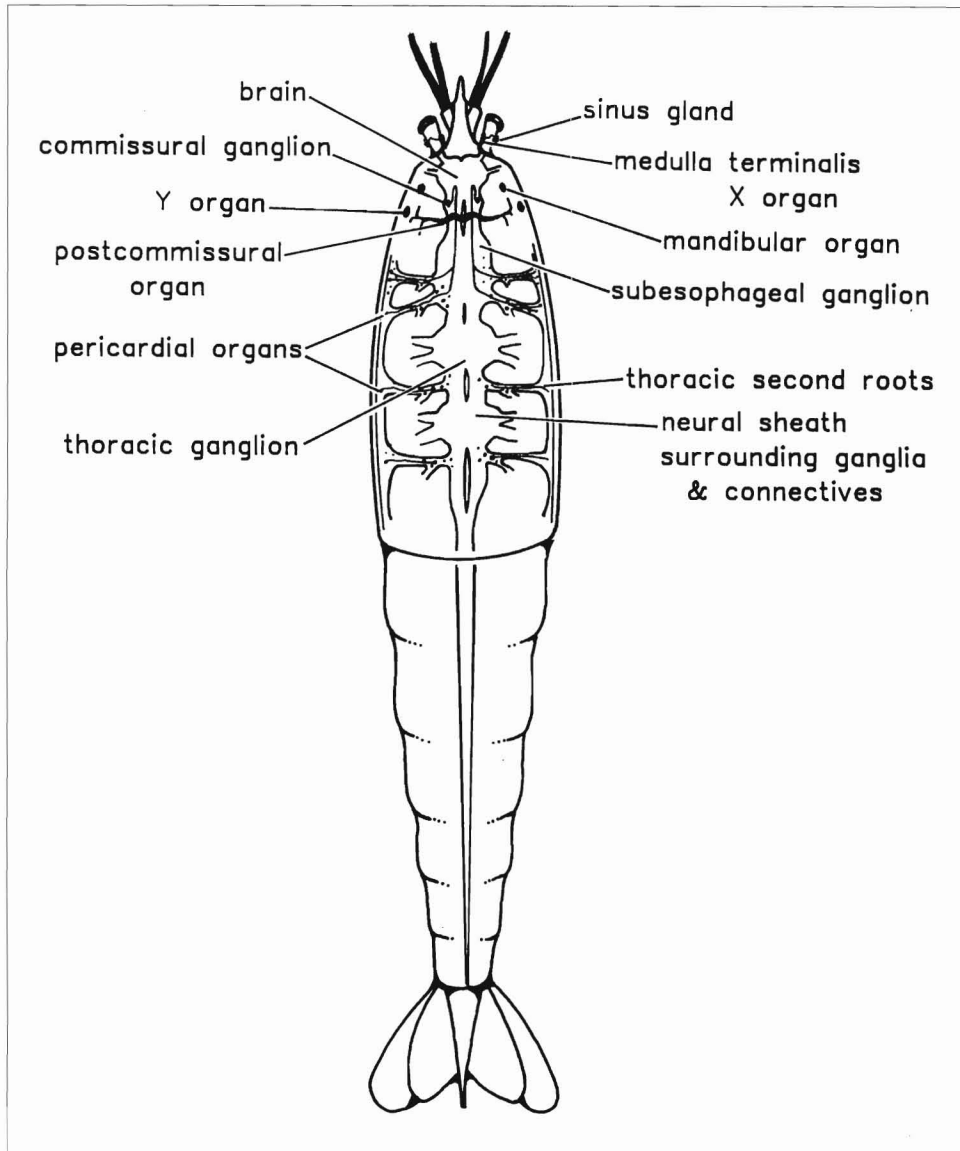
Basic knowledge of female reproduction is of primary importance to crustacean aquaculture. Our approach has been to investigate crustacean reproduction utilizing the approach of comparative endocrinology. This paper reviews the hormonal regulation of reproduction, focusing on eyestalk factors and the mandibular organ, and the target tissues affected by their secretions. This approach has led to the finding of methyl farnesoate (MF), an unepoxidated juvenile hormone, in the circulatory system. MF is produced by the mandibular organ (MO), a homologue of the insect corpus allatum, and appears to be a crustacean juvenile hormone. Eyestalk ablation enhances crustacean reproduction by removal of a gonad inhibitory hormone (GIH). Eyestalk removal in the spider crab, *Libinia emarginata*, stimulates egg production and vitellogenesis in nonreproductive females and increases MF production by the MO. Addition of sinus gland extracts to MOs inhibits MF synthesis in vitro. Thus, there is a mandibular organ inhibitory hormone in the eyestalk which may be similar or identical to GIH. The action of GIH then may be on target tissues such as the hepatopancreas and ovary or may also be on the MO. Whether this is the major action of GIH or one of its actions remains the subject of current investigations. Additional interactions influencing the female reproductive system such as stimulatory factors from the brain and thoracic ganglion as well as the role of biogenic amines are considered briefly. Other possible interactions mentioned in the literature are also indicated in this brief review of crustacean reproduction.

## Introduction

Decapod crustaceans represent a large, diverse biological group with significant potential as an aquacultural resource. Large-scale penaeid shrimp culture industries currently exist in Asia and Central America. Crayfish are grown in the United States, Europe, and Australia, and prawns of the genus *Macrobrachium* are cultivated in many tropical environments. The culture of lobsters and other species may

become viable endeavors in the future. In some cases, such as the culture of penaeid shrimp, the production of sufficient healthy seed organisms has hindered farming. A lack of understanding of the reproductive process has forestalled selective breeding. We feel that a better understanding of the hormonal mechanisms that regulate the reproduction of these valuable resources is fundamental to successful aquaculture.

During the past two decades our understanding of crustacean reproductive endocrinology, especially



**Figure 1**

Major endocrine and neuro-endocrine structures of generalized female Crustacea. Included are the organs important for female reproduction, the eyestalk sinus gland x-organ, the mandibular organ, Y-organ, and thoracic ganglion.

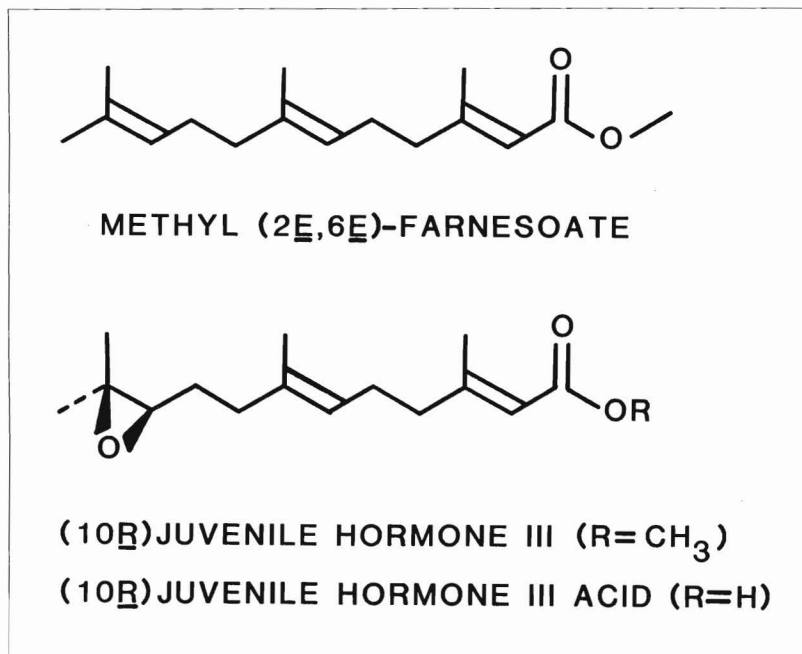
that of the female, has grown steadily. This is in part a result of the use of the comparative approach, whereby our understanding of other crustacean groups and their close relatives, the insects, is applied to the decapods. Major sites of endocrine activity are shown in Figure 1. In this report we concentrate on eyestalk factors and the mandibular organ, and the target tissues affected by their secretions. Additional endocrine interactions will be discussed as they relate to the reproductive process.

### A Crustacean Juvenile Hormone

The role of the terpenoid hormones, collectively known as the "juvenile hormones" (JHs) or juvenoids (Fig. 2), has been well established in insect reproduc-

tion. The JHs are produced in a pair of small endocrine glands, the corpora allata (CA), usually posterior and ventral to the brain. The JHs appear to play a major part not only in the development of the insect larval stages (hence the name "juvenile") but also in the regulation of reproduction (Downer and Laufer 1983), first by stimulating the ovary to mature and then by stimulating the fat body to make yolk proteins. Further, JH seems to alter the oocyte membrane so that the large yolk proteins synthesized by the fat body can be taken up by the developing egg.

Since both arthropod subphyla, the Insecta and Crustacea, are already known to regulate molting with identical hormones, 20-hydroxyecdysone (Karlson 1956; Hampshire and Horn 1966), we (*cf.* Laufer et al. 1987c) speculated that the crustacea might also have a functioning JH. This speculation



**Figure 2**

The structural formula of insect juvenile hormone (JHIII) and its metabolic breakdown product, JH acid, are compared with a similar molecule, methyl farnesoate (MF), present in crustacean hemolymph and synthesised by the mandibular organs.

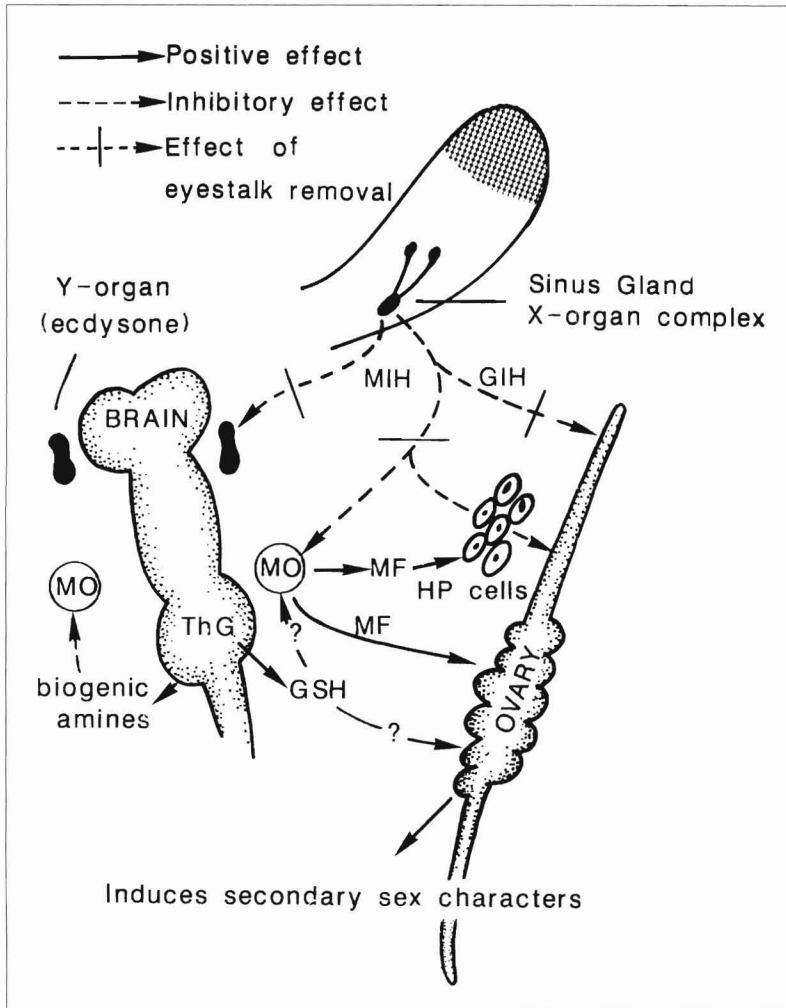
was supported by a considerable literature. Gomez et al. (1973) found that the cyprid to spat metamorphosis of the barnacle, *Balanus galeatus*, could be inhibited by two structural analogs of the JHs, methoprene and hydroprene. Similar studies were carried out by Cheung and Nigrelli (1973) and Tighe-Ford (1977). Landau and Finney (1977) showed that JH analogs are active, but that mevalonic acid, a precursor of JH, had no effect. Furthermore, precocene II, a compound that destroys the CA in insects and thereby halts the production of JH, was shown to strongly inhibit the hatching of barnacle embryos treated in the early stages of development (Landau and Rao 1980). Such effects were revealed in other crustaceans as well. JH analogs were demonstrated to cause morphological abnormalities in megalopa larvae of the crab *Rhithropanopeus harrisi* (Costlow 1977), and to alter the morphology and length of development of the American lobster *Homarus americanus* (Hertz and Chang 1986). Injection of a juvenile hormone into larval *H. americanus* results in delayed metamorphosis and morphometric variability in newly metamorphosed animals (Charmantier et al. 1988).

Beside affecting development, JHs and their analogs were also shown to affect reproduction. Inhibition of reproduction in the cladoceran *Daphnia magna* was shown by Templeton and Laufer (1983), and inhibition of oogenesis and spermatogenesis were demonstrated in the mud crab *R. harrisi* (Payen and Costlow 1977), and the spider crab *Libinia emarginata* (Hinsch 1981). Paulus and Laufer (1982)

and Paulus (1984) showed that when methoprene was injected into intact and ablated female crabs, *Carcinus maenas*, the ovaries became enlarged.

While these experiments demonstrated that Crustacea were sensitive to JH, it was not established that crustaceans possessed endogenous juvenoids. Using an insect bioassay, Schneiderman and Gilbert (1958) detected some JH activity in the eyestalks of Crustacea, but the chemical nature of the extract was not investigated. When thoracic ganglia or mandibular organs (MOs) were implanted into immature *L. emarginata*, there was a stimulation of vitellogenesis (Hinsch and Bennett 1979; Hinsch 1980). Based on morphological studies, the MO was suggested as a possible homolog to the insect CA (Chaudonneret 1956; Le Roux 1968; Byard et al. 1975). If the MO was a structural homolog of the CA, it was reasoned (Laufer et al. 1987c) that it might produce one of the juvenile hormones or a similar compound.

Methyl farnesoate (MF), the unepoxidated form of JHIII (Fig. 2), was detected in the hemolymph of *L. emarginata* using gas chromatography/mass spectrometry and selected ion monitoring (Laufer et al. 1987c) and in the hemolymph of crayfish *Orconectes virilis* and *H. americanus* as well (Tsukimura et al. 1989). When the MOs of crustaceans were incubated in physiological saline supplemented with a labelled precursor, [*methyl*-<sup>3</sup>H] methionine, it was identified as the source of the MF (Laufer et al. 1986, 1987c; Borst et al. 1987). Mandibular organs from 12 species of Crustacea are known to produce MF, most are Decapoda, but also a barnacle, *Balanus nubilis*, pro-



**Figure 3**

Major endocrine glands and their target tissues involved in crustacean female reproduction. Indicated with solid lines and arrows are stimulatory effects. Inhibitory interactions are indicated with dashed lines and arrows. Note that the inhibitory interactions from the eyestalk sinus gland x-organ complex can be removed by eyestalk ablation. These include both the inhibitory effects of the molt inhibitory hormone (MIH) on the Y-organ which produces ecdysones and the gonad inhibiting hormone (GIH), which according to the literature may be similar or the same as the vitellogenin inhibitory hormone (VIH) and which may also inhibit the mandibular organ (MO-IH) as well as other target tissues such as the ovary and hepatopancreas (HP). The brain and thoracic ganglion (ThG), according to some reports, may also stimulate or inhibit reproduction, or do both. Biogenic amines such as serotonin and octopamine have been shown to inhibit the MO.

duces MF. Based on a similar set of in vitro studies, Tobe et al. (1989) has suggested that farnesoic acid rather than MF is the major product of the MO in the mud crab *Scylla serrata* although only MF was detected in the hemolymph.

In the insects, JH produced by the CA is reversibly bound to a "carrier protein" (Downer and Laufer 1983), which functions to protect the hormone from enzymatic degradation and to increase its solubility in the hemolymph. Likewise, it appears that a similar protein, of about 40 kd, exists in the hemolymph of the lobster (Prestwich et al. 1990) and perhaps in other crustaceans. In *L. emarginata*, MF does not appear to be converted to JHIII in the hemolymph or by a variety of assayed tissues; it is, however, catabolized to farnesoic acid by a number of tissues, especially the hepatopancreas, but not by the hemolymph (Laufer and Albrecht 1990).

Like JH in insects, the production of MF seems to be related to reproduction. In female *L. emarginata*, the rate of MF secretion by MOs in vitro is correlated

with the reproductive cycle; during the reproductive season, they produce eggs in a regular cycle every 19–20 days. The MO is least active immediately after the eggs are laid and most active during vitellogenesis; it continues its activity until just before the embryos hatch and oviposition of a new brood commences (Laufer et al. 1987c). Hinsch (1980) stimulated ovarian development in juvenile female spider crabs by implanting adult MOs, so the MO seems to be a stimulus for the vitellogenic cycle in *L. emarginata*. Vogel and Borst (1989) injected MF into eyestalkless female *L. emarginata*, which according to the findings of Panouse 1943 would enlarge their ovaries, and measured the change in hemolymph vitellogenins by enzyme-linked immunosorbent assay (ELISA); a single injection (0.5 to 2.0 ng of MF) caused a modest rise in the hemolymph protein titer. Similarly, Paulson and Skinner (1988) suggested that MF increased the in vitro synthesis of specific integumentary tissue proteins of the land crab *Gecarcinus lateralis*. The proteins stimulated were different from

those stimulated by 20-hydroxyecdysone, while JH stimulated fewer proteins than MF.

### Relationship of the Mandibular Organ and Eyestalk to Reproduction

The observation by Panouse (1943) that eyestalk ablation enhances ovarian growth, vitellogenesis, and oviposition has already been mentioned here. Thus, reproduction in crustaceans appears to be under the inhibitory control of an eyestalk factor known as the "gonad-inhibiting hormone" (GIH), which may be the same as the "vitellogenin-inhibiting hormone" (VIH) (Brown and Jones 1949; Quackenbush and Herrnkind 1981; Soyez et al. 1987). The eyestalk is a source of many other hormones, including the "molt-inhibiting hormone" (MIH) which directly inhibits ecdysterone production by the Y-organs in culture (Mattson and Spaziani 1985, a and b; Schoettker and Gist 1990) (Fig. 3). Recently a molt-inhibiting hormone has been purified and its amino acids sequenced from the lobster *H. americanus*. The peptide has 61% sequence identity with crustacean hyperglycemic hormone, (CHH) from *Carcinus maenas*, and shows significant CHH activity when injected into *H. americanus* (Chang et al. 1990). It appears that crustaceans alternate between production of MIH and GIH (Anilkumar and Adiyodi 1980; Chang 1984). Fyhn et al. (1977) suggested that in barnacles 20-hydroxyecdysone may be the functional GIH, and Kallen and Meusy (1989) have advanced the theory that GIH is similar in structure, but distinct from CHH. Quackenbush and Herrnkind (1983) and Charniaux-Cotton (1985) demonstrated that MIH and GIH could be separated chromatographically.

Presumably because the eyestalk is the site of GIH production, the ablation of the eyestalk may cause increased growth of the ovarian tissue (Panouse 1943; Brown and Jones 1949; de Leersnyder and Dhainaut 1978). From an aquacultural perspective, eyestalk ablation may not be a desirable method of increasing the stock's reproductive potential. The resulting embryos often are of inferior quality (Anilkumar and Adiyodi 1985; Choy 1987) because either hormonal imbalances are created by eyestalk ablation or GIH release is uncontrolled, or both. It has been suggested that the targets of GIH are the ovaries and hepatopancreas which are the sites of yolk protein synthesis (Fig. 3) (Paulus 1984; Paulus and Laufer 1987; Quackenbush 1989). Quackenbush and Keeley (1987) showed that partially purified eyestalk extracts from the shrimp *Penaeus vannamei*

could inhibit crab *Uca pugilator* ovarian synthesis of vitellogenin in vitro, while Eastman-Reks and Fingerman (1984) also found that *U. pugilator* eyestalk extracts inhibit protein synthesis in cultured ovaries of the crab.

Alternatively, GIH may have non-ovarian targets, or in fact there may be more than one eyestalk factor which inhibits ovarian growth. In the insects, the production of JH is regulated by neuropeptides: allatotropins which stimulate the synthesis or release, or both, of hormones (Kataoka et al. 1989), and allatostatins and allatohibins which inhibit hormone synthesis/release (Girardie 1983; Woodhead et al. 1989). If there is synthesis of one of the inhibitors, thus preventing JH production and release, there will be no ovarian development; that is, the allatohibins and allatostatins are functional insect analogs of crustacean GIH. Laufer et al. (1986 and 1987a,b) found that a water-soluble, heat-stable eyestalk factor(s) inhibits the in vitro synthesis of MF (Fig. 3). Based on its extraction properties, it seems likely that this factor is a small peptide. We have termed this peptide the "mandibular organ-inhibiting hormone" (MO-IH). Laufer et al. (1986, 1987a, b, and c), showed that the levels of MF in the hemolymph of the spider crab increased dramatically after eyestalk-ablation, which was also observed in *H. americanus* and *O. virilis* (Tsukimura et al. 1989).

In addition to the eyestalk GIH/MO-IH, there is another, the "gonad-stimulating hormone" (GSH) that is reported to be produced in the thoracic ganglion, and which may contribute to the control of reproduction (Fig. 3). Otsu (1960, 1963) first suggested its existence because eyestalk ablation caused precocious ovarian growth in adult crabs, *Potamon dehaani*, but not in juveniles; he reasoned that not only was the absence of GIH required for ovarian growth, but the presence of a stimulatory hormone was also necessary. When adult thoracic ganglia were implanted in eyestalk-ablated juveniles the ovaries began to mature. These experiments were confirmed by Hinsch and Bennet (1979) using *L. emarginata*. Gomez (1965) found that the thoracic ganglion, as well as the brain, stimulated growth of reproductive tissue in *Paratelphusa hydrodromous*; similar results were reported by Takayanagi et al. (1986) in the shrimp *Paratya compressa*. Extracts of the thoracic ganglia of *U. pugilator* sampled during their reproductive season stimulated ovarian growth in intact and eyestalk-ablated crabs, but extracts of the thoracic ganglia of crabs outside the reproductive season resulted in inhibition of ovarian growth in ablated organisms (Eastman-Reks and Fingerman 1984). More recently Yano et al. (1989) reported in a small

number of cases that implants of *H. americanus* thoracic ganglia into non-reproductive *Penaeus vannamei* stimulated ovarian maturation.

### Mechanisms of Methyl Farnesoate Regulation and Action

In an effort to understand the inhibitory action of the eyestalk on the MO, we surveyed the literature on the control (secretion or synthesis) of JH by insect neuropeptides. A peptide extracted from the insect corpora cardiaca (CC) was reported by Applebaum and Moshitzky (1986) to inhibit yolk production in *Locusta migratorioides*; this peptide reacted with an antibody to adipokinetic hormone (AKH). Since AKH is very similar in structure to crustacean "red-pigment-concentrating hormone" (RPCH) (Fernlund and Josefsson 1968; Gade 1990), and because inhibition of yolk protein synthesis might be the result of a substance that acts directly on the insect CA, it was decided that the effect upon MF synthesis should be determined. Unexpectedly at  $10^{-6}$  M RPCH significantly stimulated, rather than inhibited, the synthesis of MF by the MOs of crayfish *Procambarus clarkii* (Landau et al. 1989). We could mimic the effect of RPCH by replacing it with the  $\text{Ca}^{2+}$  ionophore A23187, and synthesis could be inhibited by culturing the tissue in  $\text{Ca}^{2+}$ -free media or including lanthanum, which replaces  $\text{Ca}^{2+}$  on cell surfaces (Weiss 1974), in the culture medium. Lambert and Fingerman (1979) had suggested that the RPCH might act as a  $\text{Ca}^{2+}$  ionophore, and  $\text{Ca}^{2+}$  seems to be involved in the regulation of JH synthesis by the CA (Aucoin et al. 1987; Kikukawa et al. 1987; Dale and Tobe 1988). Furthermore, we found that "pigment dispersing hormone" (PDH) (Rao et al. 1985) at  $10^{-7}$  M significantly inhibited MO synthesis of MF in *P. clarkii* (Landau et al. 1989). It is interesting to note that Mangerich et al. (1986) found cells in the thoracic ganglia of the crab *Carcinus maenas* that contained RPCH-like molecules using immunocytochemical techniques.

Kravitz and collaborators (Beltz 1988) reported that the biogenic amines, serotonin and octopamine, play a significant role in determining mating behavior in the lobster *H. americanus*. The synthesis of MF by crab MOs also appears to be regulated in part by certain biogenic amines. Disaggregated MO cells from *Libinia emarginata* appear to be unaffected by dopamine and are only slightly inhibited by octopamine; however, serotonin inhibited MF synthesis by 20-35% at  $10^{-8}$  M, suggesting that it may function as a neuroregulator (Homola et al. 1989). Octopamine stimulates JH synthesis from *Locusta*

*migratoria* CA in vitro (Lafon-Cazal and Baehr 1988). Biogenic amines are known to affect the levels of cAMP, and to a lesser extent cGMP, in the insect *corpora cardiaca*, the site of AKH synthesis (Pannabecker and Orchard 1986; Gole et al. 1987). Tsukimura et al. (1986) treated lobster MOs with eyestalk, brain, and thoracic ganglion extracts; they found that the eyestalk extracts significantly increased the level of cGMP, but not cAMP, in the MO, while the other extracts had no effects.

### Other Hormones Regulating Reproduction

The molting hormones, ecdysteroids, are known to play a role in insect reproduction, and therefore may act in a similar fashion in crustaceans. We have already alluded to the apparent molting-reproduction antagonism. Blanchet et al. (1979) found 20-hydroxyecdysone in the ovaries of the amphipod *Orchestia gammarellus* and speculated that, although molting hormones seem to influence the growth of the oocytes, vitellogenesis itself was unaffected. It was later demonstrated that if the Y-organ of *O. gammarellus* is destroyed at the beginning of the molt cycle the ovary will not develop, and if it is destroyed during ovarian growth the synthesis of vitellogenins stops (Meusy and Charniaux-Cotton 1984). Suzuki (1986) also found that the Y-organ was required for oocyte growth in the isopod *Armadillium vulgare*. In the decapods, Lachaise et al. (1981) showed an increase in the levels of another molting hormone, ponasterone A, in ovaries of the crab *Carcinus maenas* during ovarian maturation. We have shown an accumulation of ecdysones in *Libinia emarginata* oocytes with release of ecdysteroids during embryogenesis (Laufer and Deak 1990).

Testosterone, progesterone, and pregnenolone, the vertebrate sex steroids, have been identified in the gonads and hemolymph of *Astacus leptodactylus* and *H. americanus* (Burns et al. 1984 and Ollevier et al. 1986, respectively). Couch et al. (1987) found significant levels of estradiol and progesterone in the MOs of *H. americanus*, and Yano (1985, 1987) reported that vitellogenesis in two species of shrimp, *Metapenaeus ensis* and *Penaeus japonicus*, could be stimulated by injections of progesterone and 17- $\alpha$ -hydroxyprogesterone. Vitellogenin synthesis in the isopod, *Idotea balthica basteri* can be stimulated by human chorionic gonadotropin (hCG) (Souty and Picaud 1984); in the prawn *Crangon crangon*, vitellogenesis was also stimulated by hCG (Bomirski and Klek-Kawinska 1976), and in another prawn, *Caridina*

*catadhari*, it not only stimulated growth of oogonial and follicular cells but also increased the rate of yolk deposition in the growing oocytes (Sarojini and Persis 1988). A molecule very similar to hCG has been identified in the prawn *Palaemon serratus* with the aid of a radioimmuno-assay with an hCG antibody (Toullec and Wormhoudt 1987). Follicle-stimulating hormone (FSH) and luteinizing hormone (LH) were also shown to increase the rate of ovarian development in the shrimp *Crangon crangon* (Zukowska-Arendarczyk 1981).

## Acknowledgments

The research reported here was supported in part by grants from the Sea Grant College Program, NOAA, NA-AA-D-SG101, a National Research Service Award from NIH, and the Lady Davis Trust. We wish also to acknowledge the artistic talents of Mary Jane Spring and the advice and technical assistance of Dr. Frank Mauri of the University of Connecticut Biotechnology Center.

## Citations

- Anilkumar, G., and K.G. Adiyodi.  
1980. Ovarian growth, induced by eyestalk ablation during the pre-breeding season, is not normal in the crab, *Paratelphusa hydrodromous* (Herbst). *Int. J. Invertebr. Reprod.* 2:95-105.  
1985. The role of eyestalk hormones in vitellogenesis during the breeding season in the crab *Paratelphusa hydrodromous* (Herbst). *Biol. Bull. (Woods Hole)* 169:689-695.
- Applebaum, S.W., and P. Moshitzky.  
1986. The involvement of brain factors in regulating vitellogenesis in the African migratory locust (*Locusta migratorioides*). *In Advances in invertebrate reproduction 4* (M. Porchet, J.C. Andries, and A. Dhainaut, eds.), p. 489. Elsevier Science Publ., Amsterdam.
- Aucoin, R.R., S.M. Rankin, B. Stay and S.S. Tobe.  
1987. Calcium and cyclic AMP involvement in the regulation of juvenile hormone synthesis in *Diploptera punctata*. *Insect Biochem.* 17:965-969.
- Beltz, B.S.  
1988. Crustacean Neurohormones. *In Endocrinology of selected invertebrate types; Invertebrate Endocrinology, Vol. 2* (H. Laufer and R.G.H. Downer, eds.), p. 235-258. A.R. Liss, Inc., NY.
- Blanchet, M.F., P. Porcheron, and F. Dray.  
1979. Variations du taux ecdysteroides au cours des cycles de mue et de vitellogenese chez le crustacea amphiphode, *Orchestia gammarellus*. *Int. J. Invertebr. Reprod.* 1:133-139.
- Bomirski, A., and E. Klek-Kawinska.  
1976. Stimulation of oogenesis in the sand shrimp, *Crangon crangon*, by human gonadotropin. *Gen. Comp. Endocrinol.* 30:239-242.
- Borst, D.W., H. Laufer, M. Landau, E.S. Chang, W.A. Hertz, F.C. Baker, and D.A. Schooley.  
1987. Methyl farnesoate and its role in crustacean reproduction and development. *Insect Biochem.* 17:1123-1127.
- Brown, F.A. Jr., and G.M. Jones.  
1949. Ovarian inhibition by a sinus-gland principle in the fiddler crab. *Biol. Bull. (Woods Hole)* 96:228-232.
- Burns, B.G., G.B. Sangalang, H.C. Freeman, and M. McMenemy.  
1984. Isolation and identification of testosterone from the serum and testes of the American lobster (*Homarus americanus*). *Gen. Comp. Endocrinol.* 54:429-432.
- Byard, E.H., R.R. Shivers, and D.E. Aiken.  
1975. The mandibular organ of the lobster, *Homarus americanus*. *Cell Tissue Res.* 162:13-22.
- Chang, E.S.  
1984. Ecdysteroids in crustacea: role of reproduction, molting, and larval development. *In Advances in invertebrate reproduction 3* (W. Engels, ed.), p. 223-230. Elsevier Science Publ., NY.
- Chang, E.S., G.D. Prestwich, and M. Bruce.  
1990. Amino acid sequence of a peptide with both molt-inhibiting and hyperglycemic activities in the lobster, *Homarus americanus*. *Biochem. Biophys. Res. Comm.*, 171:818-826.
- Charmantier, G., M. Charmantier-Daures, and D.E. Aiken.  
1988. Larval development and metamorphosis of the American lobster *Homarus americanus* (Crustacea, Decapoda): effect of eyestalk ablation and juvenile hormone injection. *Gen. Comp. Endocrinol.* 70:319-333.
- Charniaux-Cotton, H.  
1985. Vitellogenesis and its control in malacostracan crustacea. *Am. Zool.* 25:197-206.
- Chaudonneret, P.J.  
1956. Le systeme nerveux de la region gnathale de l'ecrevisse *Cambarus affinis* (Say). *Ann. Sci. Nat.: Zool. Biol. Anim.* 18:33-61.
- Cheung, P.J., and R.F. Nigrelli.  
1973. The development of barnacles from cyprids in pre-heated seawater, with and without farnesol. *Am. Zool.* 9, 618 p.
- Choy, S.C.  
1987. Growth and reproduction of eyestalk ablated *Penaeus canaliculatus* (Olivier, 1811) (Crustacea:Penaeidae). *J. Exp. Mar. Biol. Ecol.* 112:93-107.
- Costlow, J.D. Jr.  
1977. The effect of juvenile hormone mimics on development of the mud crab, *Rhithropanopeus harrisi* (Gould). *In Physiological responses of marine biota to pollutants* (A. Calabrese, F.P. Thurburg, and J.F. Vernberg, eds.) p. 439-457. Acad. Press, NY.
- Couch, E.F., N. Hagino, and J.W. West.  
1987. Changes in estradiol and progesterone immunoreactivity in tissues of the lobster, *Homarus americanus*, with developing and immature ovaries. *Comp. Biochem. Physiol.* 87A:765-770.
- Dale, J.F., and S.S. Tobe.  
1988. The effect of a calcium ionophore, a calcium channel blocker and calcium-free medium on juvenile hormone release *in vitro* from corpora allata of *Locusta migratoria*. *J. Insect Physiol.* 34:451-456.
- de Leersnyder, M., and A. Dhainaut.  
1978. Evolution du metabolisme ovocytaire apres ablation des pedoncles oculaires chez le crabe *Eriocheir sinensis*. Etude autoradiographique. *Arch. Zool. Exp. Gen.* 119:399-407.

- Downer, R.G.H., and H. Laufer.  
1983. Endocrinology of insects. *Invertebrate Endocrinology* Vol. 1. Alan R. Liss, NY, 707 p.
- Eastman-Reks, S., and M. Fingerman.  
1984. Effects of neuroendocrine tissue and cyclic AMP on ovarian growth *in vivo* and *in vitro* in the fiddler crab, *Uca pugilator*. *Comp. Biochem. Physiol.* 79A:679-684.
- Fernlund, P., and L. Joseffson.  
1968. Chromactivating hormones of *Pandalus borealis*. Isolation and purification of the red-pigment concentrating hormone. *Biochim. Biophys. Acta* 158:262-273.
- Fyhn, U.E.H., H.J. Fyhn, and J.D. Costlow.  
1977. Cirriped vitellogenesis: effect of ecdysone *in vitro*. *Gen. Comp. Endocrinol.* 32:266-271.
- Gade, G.  
1990. The adipokinetic hormone/red pigment-concentrating hormone peptide family: structures, interrelationships and functions. *J. Insect Physiol.* 36:1-12.
- Girardie, A.  
1983. Neurosecretion and reproduction. *In Endocrinology of Insects, Invertebrate Endocrinology Vol 1* (R. Downer and H. Laufer, eds.), p. 305-317. Alan R. Liss, NY.
- Gole, J.W.D., G.L. Orr, and R.G.H. Downer.  
1987. Pharmacology of octopamine-, dopamine-, and 5-hydroxytryptamine-stimulated cyclic AMP accumulation in the corpus cardiacum of the American cockroach, *Periplaneta americana*, L. *Arch. Insect Biochem. Physiol.* 5:119-128.
- Gomez, R.  
1965. Acceleration of development of gonads by implantation of brain in the crab *Paratelphusa hydrodromous*. *Naturewiss* 52, 217 p.
- Gomez, E.D., D.J. Faulkner, W.A. Newman, and C. Ireland.  
1973. Juvenile hormone mimics: effects on cirriped crustacean metamorphosis. *Science* 179:813-814.
- Hampshire, F., and D.H.S. Horn.  
1966. Structure of crustecdysone, a crustacean molting hormone. *Chem. Comm.* 1966:37-38.
- Hertz, W.A., and E.S. Chang.  
1986. Juvenile hormone effects on metamorphosis of lobster larvae. *Int. J. Invertebr. Reprod. Dev.* 10:71-77.
- Hinsch, G.W.  
1980. Effect of mandibular organ implants upon the spider crab ovary. *Trans. Am. Microsc. Soc.* 99:317-322.  
1981. Effects of juvenile hormone mimics on the ovary in the immature spider crab, *Libinia emarginata*. *Int. J. Invertebr. Reprod.* 3:237-244.
- Hinsch, G.W., and D.C. Bennet.  
1979. Vitellogenesis stimulated by thoracic ganglion implants into destalked immature spider crabs, *Libinia emarginata*. *Tissue and Cell.* 11:345-351.
- Homola, E., M. Landau, and H. Laufer.  
1989. The effects of biogenic amines on methyl farnesoate synthesis by disaggregated mandibular organ cells from the spider crab, *Libinia emarginata*. *Am. Zool.* 29, 61A.
- Kallen, J. and J.-J. Meusy.  
1989. Do the neurohormones VIH (vitellogenesis inhibiting hormone) and CHH (crustacean hyperglycemic hormone) of crustaceans have a common precursor? Immunolocalization of VIH and CHH in the X-organ sinus gland complex of the lobster, *Homarus americanu*. *Invert. Reprod. Develop.* 16:43-52.
- Karlson, P.  
1956. Biochemical studies on insect hormones. *Vitamins Hormones* 14:227-266.
- Kataoka, H., A. Toschi, J.P. Li, R.L. Carney, D.A. Schooley, and S.J. Kramer.  
1989. Identification of an allatotropin from adult *Manduca sexta*. *Science* 243:1481-1483.
- Kikukawa, S., S.S. Tobe, S. Solowiej, S.M. Rankin, and B. Stay.  
1987. Calcium as a regulator of juvenile hormone biosynthesis and release in the cockroach, *Diploptera punctata*. *Insect Biochem.* 17:179-187.
- Lachaise, F., M. Goudeau, C. Hetru, C. Kappler, and J.A. Hoffmann.  
1981. Ecdysteroids and ovarian development in the shore crab, *Carcinus maenas*. *Hoppe Seylers Zeitschrift Physiol. Chem.* 362:521-529.
- Lafon-Cazal, M. and J.C. Baehr.  
1988. Octopaminergic control of corpora allata activity in an insect. *Experientia* 44:895-896.
- Lambert, D.T., and M. Fingerman.  
1979. Evidence implicating calcium as a second messenger for red pigment-concentrating hormone in the prawn, *Palaemonetes pugio*. *Physiol. Zool.* 52:497-508.
- Landau, M., and C. Finney.  
1977. Insect juvenile hormones and their mimics; applications in crustacean research. *Fl. Sci.* 40 (Suppl.), 14 p.
- Landau, M., and K.R. Rao.  
1980. Toxic and sublethal effects of precocene II on the early developmental stages of the brine shrimp *Artemia salina* (L.) and the barnacle *Balanus eburneus* Gould. *Crustaceana* 39:218-221.
- Landau, M., H. Laufer, and E. Homola.  
1989. Control of methyl farnesoate synthesis in the mandibular organ of the crayfish *Procambarus clarkii*: evidence for peptide neurohormones with dual functions. *Invert. Reprod. Develop.* 16:165-168.
- Laufer, H., and K. Albrecht.  
1990. Metabolism of methyl farnesoate *in vitro* by peripheral tissues of the spider crab *Libinia emarginata* (Decapoda). *Adv. Invert. Reprod.* 5:217-277.
- Laufer, H., and P. Deak.  
1990. Ecdysteroids in maternal and embryonic *Libinia emarginata*. *Invert. Reprod. Devel.* 18:121.
- Laufer, H., E. Homola, and M. Landau.  
1987a. Control of methyl farnesoate synthesis in crustacean mandibular organs. *Am. Zool.* 27, 69A.
- Laufer, H., M. Landau, D. Borst and E. Homola.  
1986. The synthesis and regulation of methyl farnesoate, a new juvenile hormone for crustacean reproduction. *In Advances in invertebrate reproduction 4* (M. Porchet, J.C. Andries, and A. Dhainaut, eds.), p. 135-143. Elsevier Science Publ., Amsterdam.
- Laufer, H., M. Landau, and E. Homola, and D. Borst.  
1987b. Methyl farnesoate: its site of synthesis and regulation of secretion in a juvenile crustacean. *Insect Biochem.* 17:1129-1131.
- Laufer, H., D. Borst, F.C. Baker, C. Carrasco, M. Sinkus, C.C. Reuter, L.W. Tsai, and D.A. Schooley.  
1987c. Identification of a juvenile hormone-like compound in a crustacean. *Science* 235:202-205.
- Le Roux  
1968. Description d'organes mandibulaires nouveaux chez les crustacés décapodes. *C.R. Acad. Science (Paris)* 266:1414-1417.
- Mangerich, S., R. Keller, and H. Dirchsen.  
1986. Immunocytological identification of structures containing putative red pigment concentrating hormone in two species of decapod crustaceans. *Cell Tissue Res.* 245:377-386.



- Mattson, M.P., and E. Spaziani.  
1985a. Cyclic AMP mediates the negative regulation of Y-organ ecdysteroid production. *Mol. Cell. Endocrinol.* 42:185-189.
- Mattson, M.P., and E. Spaziani.  
1985b. 5-hydroxytryptamine mediates release of molt-inhibiting hormone activity from isolated crab eyestalk ganglia. *Biol. Bull.* 169:246-255.
- Meusy, J.-J., and H. Charniaux-Cotton.  
1984. Endocrine control of vitellogenesis in malacostraca crustaceans. *In Advances in invertebrate reproduction 3* (W. Engles, ed.), p. 231-241. Elsevier Science Publishers, NY.
- Ollevier, F., D. De Clerck, H. Diederik, and A. De Loof.  
1986. Identification of non-ecdysteroid steroids in the hemolymph of both male and female *Astacus leptodactylus* (Crustacea) by gas chromatography-mass spectrometry. *Gen. Comp. Endocrinol.* 61:214-228.
- Otsu, T.  
1960. Precocious development of the ovaries in the crab, *Potamon dehaani*, following implantation of thoracic ganglion. *Annot. Zool. JPN.* 33:90-96.
- Otsu, T.  
1963. Bihormonal control of sexual cycle in the freshwater crab, *Potamon dehaani*. *Embryologia* 8:1-20.
- Pannabecker, T., and I. Orchard  
1986. Pharmacological properties of octopamine-2 receptors in locust neuroendocrine tissue. *J. Insect Physiol.* 32:909-915.
- Panouse, J.B.  
1943. Influence de l'ablation de pedoncle oculaire sur la croissance de l'ovaire chez la crevette *Leander serratus*. *C.R. Acad. Science (Paris)* 217:553-555.
- Paulson, C.R., and D.M. Skinner.  
1988. Molecular action of 20-hydroxyecdysone, methyl farnesoate, and juvenile hormone on crab tissue. *Am. Zool.* 28, 83A.
- Paulus, J.E.  
1984. Hormonal control of vitellogenesis in a decapod crustacean (Brachyura). Ph.D. diss., Univ. Connecticut, Storrs.
- Paulus, J.E. and H. Laufer.  
1982. Vitellogenesis in the hepatopancreas and ovaries of *Carcinus maenas*. *Biol. Bull. (Woods Hole)* 163:375-376.  
1987. Vitellogenocytes in the hepatopancreas of *Carcinus maenas* and *Libinia emarginata*. *Int. J. Invertebr. Reprod. Dev.* 11:29-44.
- Payen, G.G., and J.D. Costlow.  
1977. Effects of a juvenile hormone mimic on male and female gametogenesis of the mud crab, *Rhithropanopeus harrisi* (Gould) (Brachyura: Xanthidae). *Biol. Bull.* 152:199-208.
- Prestwich, G.D., M.J. Bruce, I. Ujvary, and E.S. Chang.  
1990. Binding proteins for methyl farnesoate in lobster tissues: detection by photoaffinity labelling. *Gen. Comp. Endocrinol.* 80:232-237.
- Quackenbush, L.S.  
1989. Yolk proteins in the hemolymph of *Penaeus vannamei*. *Am. Zool.* 29, 63A.
- Quackenbush, L.S. and W.F. Herrnkind  
1981. Regulation of molt and gonadal development in spiny lobster *Panulirus argus* (Crustacea: Palinuridae): effects of eyestalk ablation. *Comp. Biochem. Physiol.* 69A:523-527.  
1983. Partial characterization of eyestalk hormones controlling molt and gonadal development in the spiny lobster, *Panulirus argus*. *J. Crustacean Biol.* 3:34-44.
- Quackenbush, L.S. and L.L. Keeley  
1987. Regulation of vitellogenesis in the fiddler crab, *Uca pugilator*. *Am. Zool.* 27, 152A.
- Rao, K.R., J.P. Riehm, C.A. Zahnaw, L.H. Kleinholz, G.E. Tarr, L. Johnson, S. Norton, M. Landau, O.J. Semmes, R.M. Sattelberg, W.H. Jorenby, and M.F. Hintz.  
1985. Characterization of a pigment-dispersing hormone in the eyestalks of the fiddler crab, *Uca pugilator*. *Proc. Nat. Acad. Sci., U.S.* 82:5319-5322.
- Srojini, R., and B. Persis.  
1988. Stimulation of oogenesis in freshwater prawn *Caridina rajadhari*, by human gonadotropin. *Comp. Physiol. Ecol.* 13:60-63.
- Schoettker, P.J., and D.H. Gist  
1990. *In vitro* ecdysteroid production by Y-organs of the blue crab, *Callinectes sapidus*. *J. Crustacean Biol.* 10:487-491.
- Schneiderman, H.A., and L.I. Gilbert.  
1958. Substances with juvenile hormone activity in crustacea and other invertebrates. *Biol. Bull.* 115:530-535.
- Souty, C., and J.-L. Picaud.  
1984. Effet de l'injection d'une gonadotropine humaine sur la synthese et la liberation de la vitellogenine par le tissu adipeux du crustace isopode marin *Idotea balthica basteri*. *Gen. Comp. Endocrinol.* 54:418-421.
- Soyez, D., J.E. Van Deijnen, and M. Martin.  
1987. Isolation and characterization of a vitellogenesis-inhibiting factor from sinus glands of the lobster, *Homarus americanus*. *J. Exp. Zool.* 244:479-484.
- Suzuki, S.  
1986. Effect of Y-organ ablation of oocyte growth in the terrestrial isopod, *Armadillium vulgare*. *Biol. Bull.* 170:350-355.
- Takayanagi, H., Y. Yamamoto, and N. Takeda.  
1986. An ovary stimulating factor in the shrimp, *Paratya compressa*. *J. Exp. Zool.* 240:203-209.
- Templeton, N.S. and H. Laufer.  
1983. The effects of a juvenile hormone analog (Altosid ZR-515) on the reproduction and development of *Daphnia magna* (Crustacea:Cladocera). *Int. J. Invertebr. Reprod. Dev.* 6:99-110.
- Tighe-Ford, D.J.  
1977. Effects of juvenile hormone analogues on larval metamorphosis in the barnacle *Elminius modestus* Darwin (Crustacea: Cirripedia). *J. Exp. Mar. Biol. Ecol.* 26:163-176.
- Tobe, S.S., D.A. Young, H.W. Khoo, and F.C. Baker.  
1989. Farnesoic acid as a major product of release from crustacean mandibular organs *in vitro*. *J. Exp. Zool.* 249:165-171.
- Toullec, J.-Y., and A. van Wormhoudt.  
1987. Variations quantitatives durant le cycle d'intermue de peptides apparentes a l'hormone de croissance humaine chez *Palaemon serratus* (Crustacea Decapoda). *C.R. Acad. Sci. Paris* 350:265-269.
- Tsukimura, B., T.M. Tanji, and F.I. Kamemoto.  
1986. Sinus gland activation of cyclic GMP in the mandibular organ of *Homarus americanus*. *Am. Zool.* 26, 91A.
- Tsukimura, B., M. Martin, M. Frinsko, and D.W. Borst.  
1989. Measurement of methyl farnesoate (MF) in crustacean hemolymph. *Am. Zool.* 29, 49A.
- Vogel, J.M., and D.W. Borst.  
1989. Spider crab yolk protein: molecular characterization and the effects of methyl farnesoate (MF) on its hemolymph levels. *Am. Zool.* 29, 49A.

- Weiss, G.G.  
1974. Cellular pharmacology of lanthanum. *Ann. Rev. Pharmacol.* 14:343-354.
- Woodhead, A.P., B. Stay, S.L. Seidel, M.A. Khan, and S.S. Tcbe.  
1989. Primary structure of four allatostatins; Neuropeptide inhibitors of juvenile hormone synthesis. *Proc. Nat. Acad. Sci. U.S.* 86:5997-6001.
- Yano, I.  
1985. Induced ovarian maturation and spawning in greasyback shrimp. *Metapenaeus ensis*, by progesterone. *Aquaculture* 47, 223-229.
1987. Effect of 17-alpha-hydroxy-progesterone on vitellogenin secretion in Kuruma prawn, *Penaeus japonicus*. *Aquaculture* 61:49-57.
- Yano, I., B. Tsukimura, J.N. Sweeney, and J.A. Wyban.  
1989. Induced ovarian maturation of *Penaeus vannamei* by implantation of lobster ganglion. *J. World. Aquacult. Soc.* 19:204-209.
- Zukowska-Arendarczyk, M.  
1981. Effect of hypophyseal gonadotropins (FSH and LH) on the ovaries of the sand shrimp *Crangon crangon*. *Mar. Biol.* 63:241-247.

# Reproduction in Cultured White Sturgeon, *Acipenser transmontanus*

GARY P. MOBERG and SERGE I. DOROSHOV

*Department of Animal Science and Aquaculture and Fisheries Program  
University of California, Davis  
Davis, CA 95616*

## Abstract

The value of sturgeon flesh and the demand for caviar makes the culture of sturgeon an exciting opportunity for aquaculture worldwide. However, a major problem in successfully adapting sturgeon to aquaculture has been the failure to produce mature domestic broodstock for egg and milt production. Even the industrial-scale sturgeon hatcheries in the U.S.S.R., which have been in operation since the late 1950s, producing fingerlings for mitigation, depend upon harvesting wild broodstock for eggs and milt. Recently in California, several private aquaculture ventures have begun to raise white sturgeon (*Acipenser transmontanus*) for the commercial market. While successful in producing marketable fish, they have not been able to raise a reliable source of domestic female broodstock and must continue to harvest wild broodstock for eggs. Females raised in culture remain reproductively immature until at least 10 years of age (the age of the oldest cultured females in California). Reproduction in these females is arrested just prior to the initiation of vitellogenesis. In this report, we discuss our observations of the reproductive maturation of captive sturgeon broodstock and review our previous efforts to manipulate their endocrine system to promote earlier sexual maturation. It appears that the hypothalamic-pituitary-gonadal axis of the cultured females is not secreting sufficient gonadotropins to induce the full maturation of the reproductive system. We have attempted to induce further reproductive maturity by hormone treatment. While we have been successful in inducing vitellogenesis in these immature cultured females by estradiol administration, the ovarian follicles will not incorporate the vitellogenin.

## Introduction

Because of the commercial value of its flesh and the use of its roe for caviar, the demand for sturgeon has been intense and has resulted in a severe exploitation of wild sturgeon stocks worldwide. The impact of this commercial exploitation on the sturgeon population has been further exacerbated by the fish's low reproductive rate. The females of most of the commercially valuable sturgeon species do not reach reproductive maturity until 15 to 20 years of age. Once a sturgeon has spawned, she may not reproduce again for several years. Further reducing fecundity is the sensitivity of these animals' reproduction to a variety of environmental disturbances, especially pollution and the damming of the rivers where they migrate to spawn. The combined result of fishing pressure and the low reproductive rate has been a dramatic decline of sturgeon stocks through-

out the world, with some species approaching extinction. One approach to assuring the survival of these species is to raise sturgeon in aquaculture operations, providing sturgeon for both mitigation and as a source of flesh and caviar.

## History of Sturgeon Culture

By the turn of the century, commercial exploitation of sturgeon in Russia had already severely diminished wild stocks. Russia has had the largest resources of sturgeon species in the world, where they reach unusually high abundance in the continental brackish water of the historic Sea of Tethys, the Caspian, Aral, and Azov Seas. The latter two are now lost as a sturgeon habitat, serving as one of the worst examples of environmental mismanagement. The largest source of sturgeon, the Caspian Sea, still holds substantial

sturgeon resources, but their fate and future commercial exploitation are endangered by the loss of natural reproduction and the increasing pollution of the sea.

The first attempt to artificially reproduce anadromous sturgeon was made in Russia by Borodin in 1898 (Borodin 1898). The first experimental hatchery operations were established in the Caspian Sea basin (Volga and Kura Rivers) in 1937–38. However, industrial-scale sturgeon hatcheries did not evolve until the late 1950's when all major spawning rivers were dammed and most of the spawning grounds for sturgeon were lost (Kozin 1964). Research lagged on sturgeon nutrition and development of intensive juvenile culture, however, resulting in over dependence of Soviet sturgeon culture on unreliable methods that even today require the harvesting of wild stock for eggs and milt. Currently the U.S.S.R.'s sturgeon culture system annually produces 70–100 million fingerlings, which are used to stock the Caspian and Azov Seas, with an estimated survival to adulthood of 1–3% (Marti 1979). It is clear that this approach to culture has succeeded in temporarily maintaining the commercial exploitation of wild sturgeon in the U.S.S.R. (approximately 20,000 metric tons annual catch). However, ecological changes in the Caspian Sea, environmental pollution, and the continuation of the commercial "caviar" fishery may endanger existing stocks.

Extensive commercial fisheries for sturgeon in North America were established during 1880–90 in the Delaware River, Great Lakes, and along the Pacific Coast. The commercial catches peaked during 1890–1900, almost approaching the levels caught in Russia; however, the catch rates rapidly declined to insignificance by 1910 (Ryder 1890; Bajkov 1949; Harkness and Dymond 1961; Semakula and Larkin 1968; Galbreath 1985; Smith 1985). Since the early part of this century, regulations for most North American sturgeon stocks here prohibited or effectively limited commercial catch. Nevertheless, there is still no single example of complete stock recovery to previous historical levels. It is also interesting that while the commercial fishery for sturgeon has practically ceased in North America, the sport fishery, especially for the white sturgeon in the Pacific Northwest, has become a major user of sturgeon resources.

The dramatic and rapid decline in sturgeon fisheries prompted early attempts to artificially reproduce sturgeon for stock replenishment. Hatchery work with atlantic (*Acipenser oxyrinchus*), lake (*A. fulvescens*) and shortnose (*A. brevirostrum*) sturgeons was pioneered during 1890–1910 (Ryder 1890; Post 1890; Stone 1901; Carter 1904; Meehan 1909; review

by Leach 1920). These attempts were only partly successful because of the difficulties with capturing ovulatory females and incubating the highly adhesive sturgeon eggs. Further development of sturgeon culture in North America apparently waned until the 1960's, when hormonally induced spawning was successfully used to breed paddlefish *Polyodon spathula* (Purkett 1963). Interest in sturgeon culture revived in the early 1980's when lake, atlantic, and white sturgeon (*A. transmontanus*) were spawned and raised to the fingerling stage in various university laboratories and state hatcheries (Smith et al. 1980; Doroshov et al. 1983; Czeskleba et al. 1985). At this time, only the artificial propagation of the white sturgeon has been established as a complete technology that includes induced spawning, egg incubation, and intensive rearing of juvenile and adult fish (Doroshov 1985; Conte et al. 1988).

The role of sturgeon culture in the restoration and replenishment of North American stocks is still insignificant, in spite of the potentially high efficiency of hatcheries to produce sturgeon juveniles. Most efforts in wild stock management are directed at environmental protection and the stringent control of the predominant recreational fisheries. The major stimulus for current attempts at developing sturgeon culture originates from the development of commercial aquaculture in the United States and Western Europe.

### Culture of White Sturgeon in California

---

The Pacific Northwest is the home for two sturgeon species—the white sturgeon and the green sturgeon, *A. medirostris*. The biology of green sturgeon is practically unknown. Although important in some geographic areas, this species is believed to be of inferior value as a food fish. In contrast, the meat of the white sturgeon has a very high market value and this species is still harvested by a small commercial fishery in the lower Columbia River. The white sturgeon is taken by sport-fishermen throughout the Pacific Northwest. As a result, its harvest by recreational fisheries in the Columbia and Sacramento Rivers has reached a rate equal to that of the earlier exploitation by commercial fisheries (Galbreath 1985), resulting in a significant threat to the wild population.

White sturgeon stocks live in the estuaries of three major rivers, Fraser, Columbia, and Sacramento. This is one of the largest sturgeon species, reaching a maximum recorded size of 1800 pounds (Moyle and

Cech 1988). Males reach first sexual maturity at 10–15 years of age, while females mature at 15–20 years of age. Ripe fish migrate into the rivers and spawn from March (Sacramento River) to June (Columbia and Fraser Rivers), at water temperatures of 14–16° C. Spawning grounds are now limited to rivers below the dams, although there are small reproducing populations in the reservoirs on the Columbia River (Galbreath 1985).

Preliminary information was recently obtained on the reproductive cycle of white sturgeon females in the San Francisco Bay (Chapman et al. 1987; Chapman 1989; Doroshov et al. 1990). The most important findings were the high individual variability in the age of first ovulation (12–22 years) and the apparently biennial vitellogenic cycle which appears to be strictly controlled by seasonal factors (photo-period and, probably, temperature). It was also noted that the females undergoing vitellogenesis exhibited elevated plasma concentrations of estrogen.

The culture of white sturgeon in California was initiated in the early 1980's by several commercial ventures. Wild fish are captured during their spawning migration in the Sacramento river. Ova and semen are obtained by injecting fish with either carp pituitary extracts or synthetic gonadotropin-releasing hormone analog (Lutes et al. 1987; Conte et al. 1988). The fertilized eggs are incubated in jars; larvae and fingerlings are raised in tanks on salmonid diets (Hung 1989).

Initially, the market for these small scale culture operations was the sale of fry to other growers and to aquarium retailers. During the past three years, several commercial ventures have established the growout of high market-value food fish. Sturgeon are raised in tanks, raceways, and earthen ponds and marketed (primarily to restaurants) at body weight 6–8 kg as 2–3 year-old fish. The growout system is also well established in several Western European ventures that produce highly prized smoked white sturgeon (such as *Agroittica Lombarda*, Calvisano, Italy). The white sturgeon is superior to many other species in the high quality of their meat, their acceptance of artificial diets, their tolerance to high density and, most importantly, their fast growth rates at water temperatures in the range of 20–23° C.

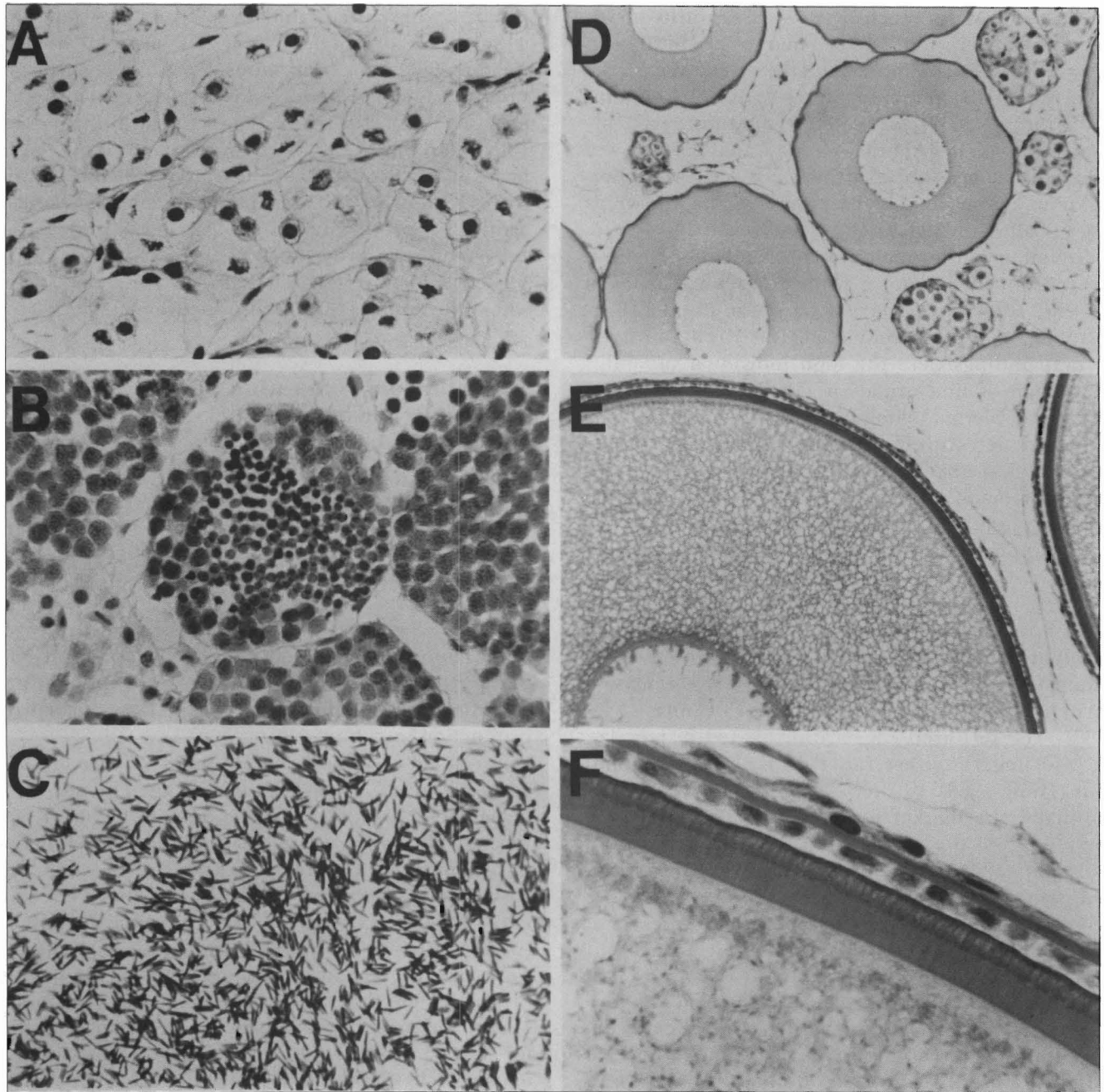
The major problem in developing a white sturgeon culture has been the lack of domestic broodstocks and dependence of fish farmers on wild broodstock capture, which is not only unreliable but severely restricted by government regulation. As a result, several aquaculture ventures in California have initiated the rearing of captive broodstocks obtained from hatchery-produced fish (F1 generation) and they now

retain a substantial number of fish, the oldest of which have reached 10 years of age and a body weight of 50 kg (Anonymous 1990). These fish are raised at low density in outdoor tanks and raceways and are fed different types of salmonid diets (Silvercup, Rangen, Moore-Clark). In 1987, eight farms started collaborative research with the University of California at Davis, in an attempt to establish artificial reproduction in captive stocks and to improve sturgeon broodstock management. The major objective of this research is to decrease the age at which the females reach reproductive maturity.

### Reproductive Maturation of Captive Broodstock

During the past two years we have performed biopsies on the gonads and collected plasma from more than 1,000 cultured sturgeon. Paraffin sections of gonadal tissue, stained by hemotoxylin and eosin (males) or by periodic acid-Schiff stain (females), have been examined microscopically. These samples have provided us with the first insight into the gonadal maturation of cultured sturgeon and has enabled us to identify the major problems that are preventing these animals from achieving normal reproduction in culture.

About 90% of the captive males mature by 3–4 years of age at a body size of 5–6 kg. The stages of testicular development are shown in Figure 1, (A through C). Spermatogenesis of these cultured males is synchronous, occurring during the summer and early fall. By October–November, testicular cysts contain ripe spermatozoa, and it is possible to induce spermiation by hormone injections. The quality of captive male semen does not differ from the quality of the semen collected from wild males (Chapman 1989), and most farmers today use only captive males for their hatchery production. It appears that the testicular cycle is annual and that the cultured males spermiate each year. The only reproductive problem that has been observed in cultured males is an apparent negative effect of warm (above 16° C) temperature on the final phase of the testicular cycle. These temperature conditions are often observed in some California farms using underground water supplies that have a constant temperature of 18–20° C. The colonies of males maintained under such conditions appear to undergo rapid testicular regression and will not spermiate during the following spring spawning season (J. Michael, Sierra Aquafarms, Elverta, CA 95626; and Ken Beer, The Fishery, Galt, CA 95632, pers. commun. 1989).



**Figure 1**

Selected stages of gametogenesis in captive white sturgeon: (A), (B) and (C) show development of testicular germ cells (hematoxylin and eosin stains, microscope magnification 315x); (D) and (E) show development of the ovarian follicle from previtellogenic (D) to early vitellogenic (E) stage, the latter observed in very few captive females (magnification 50x); (F) peripheral area of early vitellogenic follicle possessing differentiated granulosa layer and egg chorion (periodic acid-Schiff stain, magnification 315x). All fish were sampled in November 1988, at age 3–5 years (males) and 5–7 years (females).

In contrast to the males, most of the captive females remain reproductively immature for up to 10 years of age, which is the age of the oldest cultured females in California. These captive females have reached a body size (40–50 kg) which is well above the size of wild females when they first reach reproductive maturity (Chapman 1989). The great

majority of cultured females stop reproductive maturation just prior to the initiation of vitellogenesis. Their ovaries complete gonial proliferation by four years of age, but the ovarian follicles remain in a refractory condition characterized by the failure to differentiate granulosa cells (Fig. 1, d through f). This reproductive block could result from a number

of environmental and husbandry factors. We are currently focusing on the role of seasonal fluctuations in water temperature and nutrition of the broodstock as the two most important factors that may be affecting reproduction in these animals.

### Endocrine Manipulation of Vitellogenesis

---

Since the sexual maturation of the cultured female sturgeon is arrested at the previtellogenic stage, we have attempted to induce vitellogenesis and trigger further ovarian maturation by hormone manipulation (Moberg et al. 1990). We implanted cellulose pellets containing various doses of estradiol into four to seven year-old white sturgeon females that were part of the first generation of wild broodstock spawned at the University of California at Davis. These fish had been raised and maintained in outdoor freshwater tanks and fed commercial trout broodstock diet (Murray Elevators). The estradiol implants not only elevated plasma concentrations of estrogen in these females, but also stimulated the synthesis of vitellogenin, raising the plasma concentration of vitellogenin to levels that were 6 to 10 times higher than the mean values observed in vitellogenic wild females (Chapman et al. 1987). In spite of these high concentrations of plasma vitellogenin, there was no evidence of any uptake of vitellogenin by the ovarian follicles, suggesting to us that the ovarian follicles were not sufficiently developed to incorporate the vitellogenin found in the plasma.

These findings suggest to us that the failure of the cultured female sturgeon to mature beyond the previtellogenic phase reflects a failure of the hypothalamic-pituitary-gonadal (HPG) axis to initiate the next stage of reproductive maturity. Since follicular development as well as estrogen synthesis is dependent upon the HPG axis to secrete sufficient gonadotropins to stimulate the next stage of ovarian development, the failure of both events to occur in the cultured females suggests that insufficient gonadotropin is being secreted in these animals. To address this problem, we sought to stimulate gonadotropin secretion by treating the animals with synthetic gonadotropin releasing hormone (GnRHa), either alone or in combination with estradiol administration. GnRHa treatment by itself did not induce estrogen synthesis and as a result had no effect on vitellogenin synthesis. The combined treatment of estrogen and GnRHa did result in significantly higher plasma concentrations of estrogen than did estradiol treatment alone, suggesting that this combined treatment may have stimulated an

increased secretion of endogenous gonadotropins which in turn stimulated endogenous estrogen synthesis. Regardless, the combined estrogen and GnRHa treatment still did not initiate sufficient follicular differentiation (i.e., granulosa cells) to permit the incorporation of vitellogenin. Since this combined treatment lasted for only 73 days, it is possible that a longer treatment period might have initiated further follicular development (Moberg et al. 1990).

From our current understanding of the endocrine control of sturgeon reproduction, it seems that manipulation of the endocrine system still is the most viable approach to inducing reproductive maturation in the cultured female sturgeon. However, to accomplish this task, it will be necessary to refine the hormone treatment practices.

### Conclusions

---

The value of sturgeon flesh coupled with the demand for caviar makes the culture of sturgeon an exciting opportunity for aquaculture not only in California, but throughout the world. The adaptation of this species to aquaculture is not only necessary for the full realization of its market potential, but may be the most viable strategy to insure the survival of this unique group of fish. While remarkable progress has been made in developing procedures to culture sturgeon, one major problem remains, full reproductive maturation of the cultured females within a time frame that makes sturgeon culture a viable economic enterprise.

The failure of the cultured females to reach full reproductive maturity appears to result from failure of the pituitary to secrete sufficient gonadotropins to induce final ovarian follicular development. The most viable approach to solving this problem seems to be the utilization of hormone treatments to either induce the secretion of gonadotropins or to duplicate the effects of these pituitary hormones. The success of such hormone therapy would not only establish full reproduction in culture but would provide a means to induce reproduction in females at a much younger age than that which occurs in the wild, making the culture of sturgeon a more economically feasible enterprise.

### Acknowledgments

---

This work is a result of research sponsored in part by NOAA, National Sea Grant College Program, Department of Commerce, Under grant number NA85AA-D-SG140, project number R/A-73, through the California Sea Grant College Program, and in part by the California State Resources Agency.

## Citations

- Anonymous.  
1990. Third annual report of domestic white sturgeon broodstock research and development program. Aquaculture and Fisheries Program, Univ. California, Davis, September, 1990, 36 p.
- Bajkov, A.D.  
1949. A Preliminary Report on the Columbia River Sturgeon. Oregon Fish Comm., Portland, Res. Brief 2:3-10.
- Borodin, N.A.  
1988. Experiments on artificial insemination of sturgeon eggs and other biological observations conducted on the Ural River in Spring 1987 [in Russian]. Vestnik Rybopromyshlennosti, St. Petersburg, Vol. 6-7.
- Carter, E.N.  
1904. Notes on sturgeon culture in Vermont. Trans. Am. Fish. Soc. 33: 60-75.
- Chapman, F.A.  
1989. Sexual maturation and reproductive parameters of wild and domestic stocks of white sturgeon, *Acipenser transmontanus*. Ph.D. diss., Univ. California, Davis.
- Chapman, F.A., R.L. Swallow, and S.I. Doroshov.  
1987. Ovarian cycle of white sturgeon (*Acipenser transmontanus*). In Proc. of 3rd int. symp. on reproductive physiology of fish. St. Johns, Newfoundland, Canada; 2-7 August 1987 (D.R. Idler, L.W. Crim, and J.M. Walsh, eds.), p. 196. Memorial Univ. Newfoundland.
- Conte, F.S., S.I. Doroshov, P.B. Lutes, and E.M. Strange.  
1988. Hatchery manual for the white sturgeon, *Acipenser transmontanus*. Coop. Ext. Univ. California, Div. Agriculture and Natural Resources, Publication 3322, 104 p.
- Czeskleba, D.G., S. AveLallemant, and T.F. Thuemler.  
1985. Artificial spawning and rearing of lake sturgeon, *Acipenser fulvescens*, in Wild Rose State Fish Hatchery, Wisconsin, 1982-1983. In North American sturgeons: biology and aquaculture potential (F.P. Binkowski and S.I. Doroshov, eds.), 79-86 p. Dr. W. Junk Publishers, Dordrecht, Netherlands.
- Doroshov, S.I.  
1985. Biology and culture of sturgeon, Acipenseriformes. In Recent advances in aquaculture, Vol. 2 (J.F. Muir and R.J. Roberts, eds.), p. 251-274. Croom Helm, London and Sydney.
- Doroshov, J.N., J.P. Van Eenennaam, F.A. Chapman, and S.I. Doroshov.  
1990. Histological study of the ovarian development in wild white sturgeon, *Acipenser transmontanus*. In Proc. of 1st int. symp. on sturgeon, Bordeaux, France; 2-5 Oct., 1989. Centre d'Études du Machinisme Agricole du Génie Rural des Eaux et Forêts, France. (In press.)
- Doroshov, S.I., W.H. Clark Jr., P.B. Lutes, R.L. Swallow, K.E. Beer, A.B. McGuire, and M.D. Cochran.  
1983. Artificial propagation of the white sturgeon, *Acipenser transmontanus*. Aquaculture 32: 93-104.
- Galbreath, J.L.  
1985. Status, life history and management of Columbia River white sturgeon, *Acipenser transmontanus*. In North American sturgeons: biology and aquaculture potential (F.P. Binkowski and S.I. Doroshov, eds.), p. 119-126. Dr. W. Junk Publishers, Dordrecht, Netherlands.
- Harkness, W.J.K., and J.R. Dymond.  
1961. The lake sturgeon: the history of its fishery and problems of conservations. Publication of Fish and Wildlife Branch, Ontario Dep. of Lands and Forests, Canada, 121 p.
- Hung, S.S.O.  
1989. Practical feeding of white sturgeon. Aquaculture Magazine 15:60-62.
- Kozin, N.I.  
1964. Sturgeon of the USSR and their artificial propagation. Uses. Nauchno-issled. Inst. Morsk. Rybn. Khoz. Okeanogr., Trudy, 52, p. 21-57.
- Leach, G.C.  
1920. Artificial propagation of sturgeon, review of sturgeon culture in the United States. Reports U.S. Fish Commission, 1919:3-5.
- Lutes, P.B., S.I. Doroshov, F. Chapman, J. Harrah, R. Fitzgerald, and M. Fitzpatrick.  
1987. Morpho-physiological predictors of ovulatory success in white sturgeon, *Acipenser transmontanus*. Aquaculture 66:43-52.
- Marti, Y.Y.  
1979. Development of sturgeon management in the southern seas of the USSR. In Biological resources of inland waters of the USSR, p. 73-85. (Publ. House Nauka, Moscow.
- Meehan, W.E.  
1909. Experiments in sturgeon culture. Trans. Am. Fish. Soc. 39:85-91.
- Moberg, G.P., S.I. Doroshov, F.A. Chapman, K.J. Kroll, J. Van Eenennaam, and J.G. Watson.  
1991. Effects of various hormone implants on vitellogenin synthesis and ovarian development in cultured white sturgeon, *Acipenser transmontanus*. In *Acipenser* (P. Williot, ed.) p. 389-399. CEMAGREF-DICOVA cedex, France. ISBN #2853622088.
- Moyle, P.B., and J.J. Cech Jr.  
1988. Fishes, introduction to ichthyology. Prentice Hall, NJ, 559 p.
- Post, H.  
1890. Sturgeon experiments in hatching. Trans. Am. Fish. Soc. 19:36-40.
- Purkett, C.A.  
1963. Artificial propagation of paddlefish. Trans. Am. Fish. Soc. 90:125-129.
- Ryder, J.A.  
1890. The sturgeon and sturgeon industries of the eastern coast of the United States, with an account of experiments bearing upon sturgeon culture. U.S. Fish Commission Bull. 8:231-328.
- Semakula, S.N., and P.A. Larkin.  
1968. Age, growth, food and yield of the white sturgeon *Acipenser transmontanus* of the Fraser Rier. J. Fish. Res. Board Can. 25:2589-2602.
- Smith, T.I.J.  
1985. The fishery, biology, and management of Atlantic sturgeon, *Acipenser oxyrinchus*, in North America. In North American sturgeons: biology and aquaculture potential. (F.P. Binkowski and S.I. Doroshov, eds.), p. 61-71. Dr. W. Junk Publishers, Dordrecht, Netherlands.
- Smith, T.I.J., E.K. Dingley, and D.E. Marchette.  
1980. Induced spawning and culture of Atlantic sturgeon. Prog. Fish-Cult. 42:147-151.
- Stone, L.  
1901. Sturgeon hatching in the Lake Champlain basin. Trans. Am. Fish. Soc. 30:137-143.



# Experimentation to Improve Recruitment of Blood Ark Shell, *Scapharca broughtonii*, in the Seto Inland Sea

SATOSHI UMEZAWA\*

Japan Sea Regional Fisheries Research Institute  
Suido-cho, Niigata 951, Japan

## Abstract

The blood ark shell *Scapharca broughtonii* is one of the most important bivalves in the coastal fishery of Japan. Recently, fishery hauls of blood ark shell have been decreasing. The blood ark shell research group of the Marine Ranching Project has studied technologies to artificially propagate spawning stocks of these species in order to increase recruitment in the natural fishery grounds. This paper reviews some of our efforts to understand the biology and ecology of ark shells and to develop techniques to improve spat collection and prevent predation from starfish.

## Introduction

The blood ark shell *Scapharca broughtonii* is one of the most important shellfish of the coastal fishery of Japan. Its distribution extends from southern Hokkaido to Kyushu in shallow bays and gulfs with muddy bottoms. Recently the fishery has decreased owing to excessive fishing pressure and the fluctuation of the natural level of the resource. Reduction in the broodstock levels of ark shell are occurring because of the large number of premature shells harvested in the wild.

Over the past decade mass production techniques yielding about 10 million spats annually per hatchery have been established in Yamaguchi and other prefectures. First, broodstock is collected by selecting spawners from the commercial catch of small trawlers during late March to early April. The selected broodstocks are then reared in small tanks without feeding for several months, becoming mature when the water temperature rises to 20° C. The spawners discharge eggs and sperm during late June to early July with temperature stimulation. Naturally spawned eggs are collected and maintained in a larval rearing tank, and newly hatched larvae are initially fed with *Paulova lutheri* or *Cheatoceeros* spp. for two months. The seeds are harvested from the tank when they reach 1 mm in shell length in September. Subsequently, the spats are reared in lantern nets until they reach

about 30-mm in shell length in the following year, from March to July. These 30-mm seeds are used for releasing into the fishery grounds and for cage cultures. In both released and cage-cultured ark shells, one can expect to harvest the shellfish two years after birth. Because it takes over three years for blood ark shells to mature sexually, these stocks will have no chance to contribute to reproduction. Therefore, the spawning stock is usually very small and may not produce a significant number of offspring.

The blood ark shell research group of the Marine Ranching Project (MRP), which consists of the Nansei Regional Fisheries Research Laboratory, the National Research Institute of Aquaculture, and the Inland Sea Fisheries Experimental Station of Yamaguchi Prefecture, has studied technologies to cultivate spawning stocks of blood ark shell. By artificially propagating seeds to an age greater than two years old, this group had attempted to increase recruitment in the natural fishery grounds (Fig. 1).

This paper outlines the research activities and some results of the blood ark shell research group in the MRP.

\* Present address: Seikai National Fisheries Research Institute, Kokubu, Nagasaki: 850, Japan.

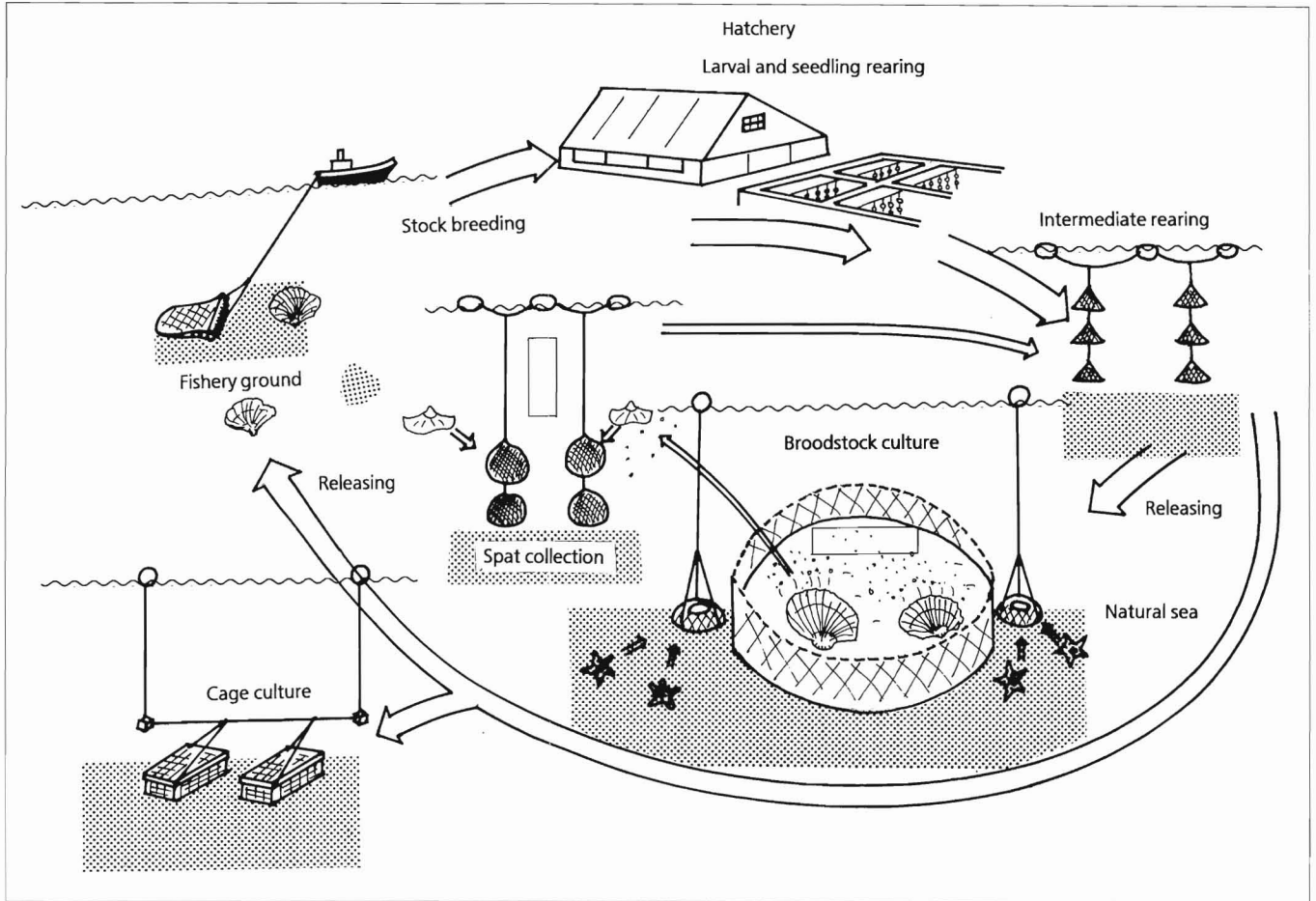


Figure 1

Schematic drawing of aquaculture of the blood ark shell. Methodology of artificial broodstock culture is studied in the Marine Ranching Project.

### Environmental Conditions for the Cultivation of Artificial Broodstock

Figure 2 shows the location of the pilot farms for the cultivation of spawning stocks in the Kasado Bay at Yamaguchi Prefecture. This bay was selected as a farming ground because 1) this area has been used previously to culture the species, 2) eggs and larvae discharged from the broodstock are expected to remain in the bay because of its topographical characteristics, and 3) the local fishermen's association cooperated in our survey and investigation.

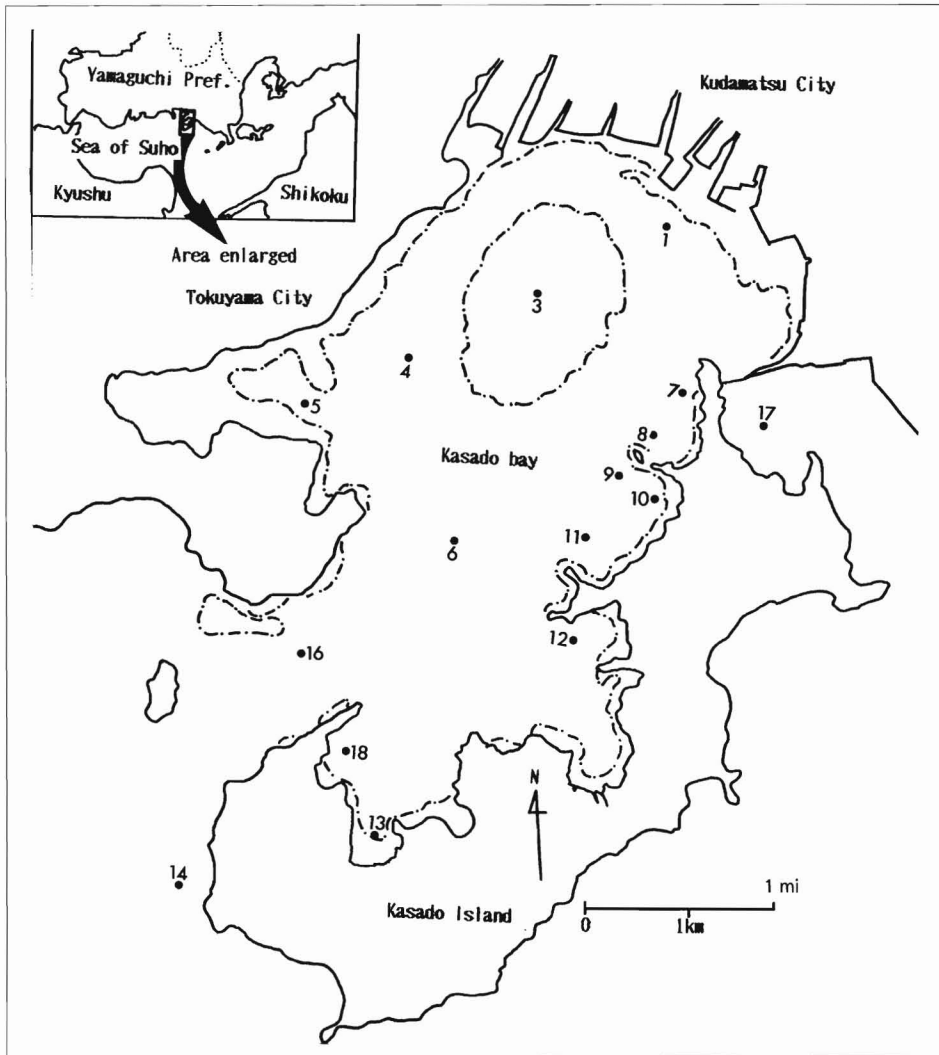
The artificially propagated seeds must be reared more than two years for use as broodstock; therefore, the farming ground must provide environmental conditions for good growth and high survival rates during cultivation.

Cage culture of 1- to 3-year-old shell was tried at six stations in Kasado Bay to investigate the growth and survival rates of blood ark shell (Umezawa et al.

1985). Water quality and bottom conditions were also surveyed at each station. Figure 3 shows the results of cage culturing 1-year-old shell during the 5-month period lasting from May to October. High survival rates and good shell growth are seen at Station 13 in comparison with the other stations. Two- and 3-year-old shells have similar survival rates.

The characteristics of the environmental conditions at Station 13 are as follows:

- Water temperature is about 1° C or more higher during the spring to early summer period than at the other stations. The water depth is shallower, about 10 m at the station.
- Water transparency is high.
- Grain size of bottom sediment is larger, about 10-20 $\mu$ m mainly.
- Organic content levels of sediment are low.



**Figure 2**  
Map of Kasado Bay and station numbers of the environmental survey (1-18). Pilot farms for the cultivation of blood ark shell are located at stations 9 and 10.

- The percentage of chlorophyll-*a* in the phyto-pigment (chlorophyll-*a* plus pheopigment [pheophytin and pheophorbide]) is large, in the bottom water.

It is suggested that the proper environmental conditions for blood ark shell propagation includes higher water temperatures during spring to early summer, not exceeding 25°C continually. The requirement for bottom conditions is sandy mud without high organic matter concentrations.

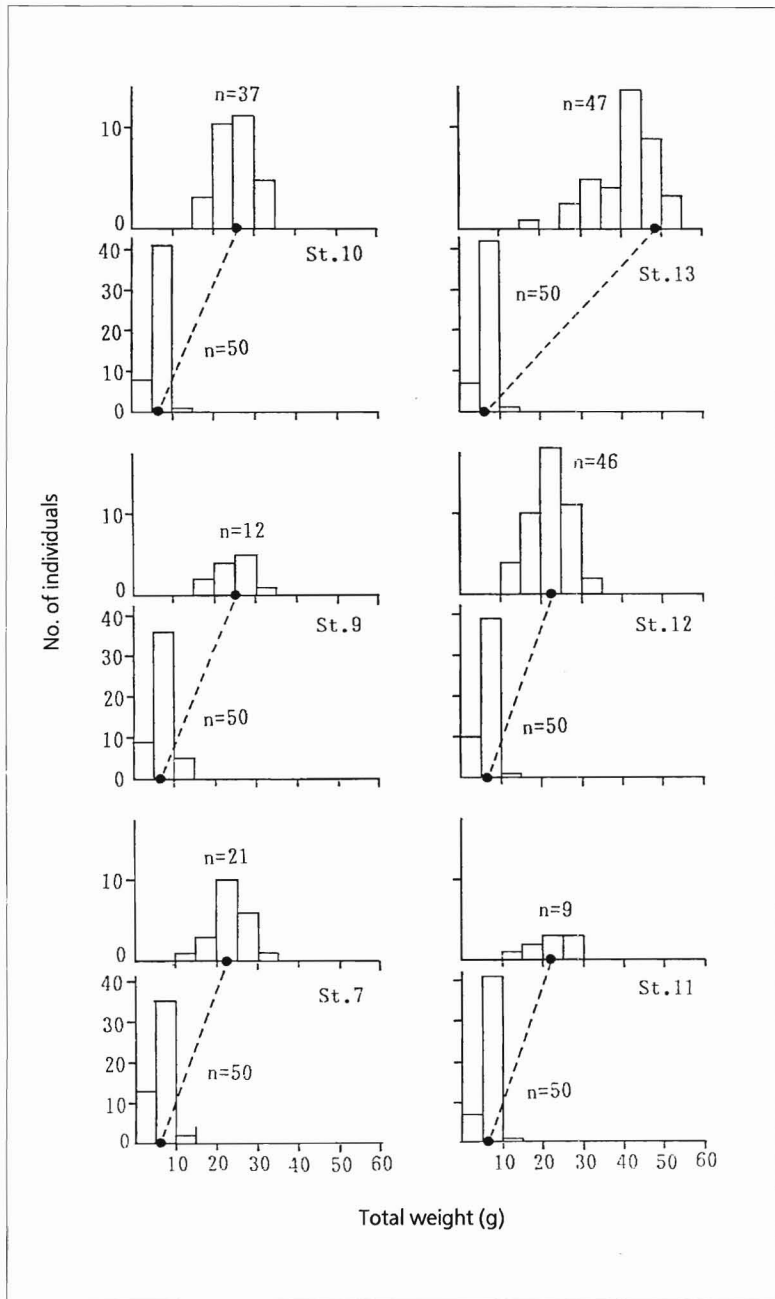
### Prevention of Predation by Starfish

High mortality occurs frequently for a few weeks after the release of the blood ark shell seeds. One of the causes is predation by starfish. Therefore, prevention of predation by starfish is essential for the cultivation of broodstock. Two methods were examined. One

was the elimination of starfish with the use of traps. The other was protection of the blood ark shell with capsules until the broodstock reached a large enough size to avoid predation (Takami and Koumoto 1986).

Figure 4 shows the arrangement of the experimental lots for predation prevention at Station 9 in Kasado Bay. Lot A shells were protected by two types of starfish traps (shown in Fig. 5), which surrounded the ark shell release area. Lot B, blood ark shells were maintained in the capsules shown in Figure 6 for protection from starfish predation. Lot C shells were a control group which received no protection from predation.

Starfish are usually present in the experimental area before the blood ark shells are released. A large number of starfish swarmed gradually after the release—the greatest concentration of them near the experimental area occurring in July. From September to October few starfish are found. In lot A, 96.5% of swarmed starfish were removed from the ark shell release area; type II was more useful than type I.



**Figure 3**

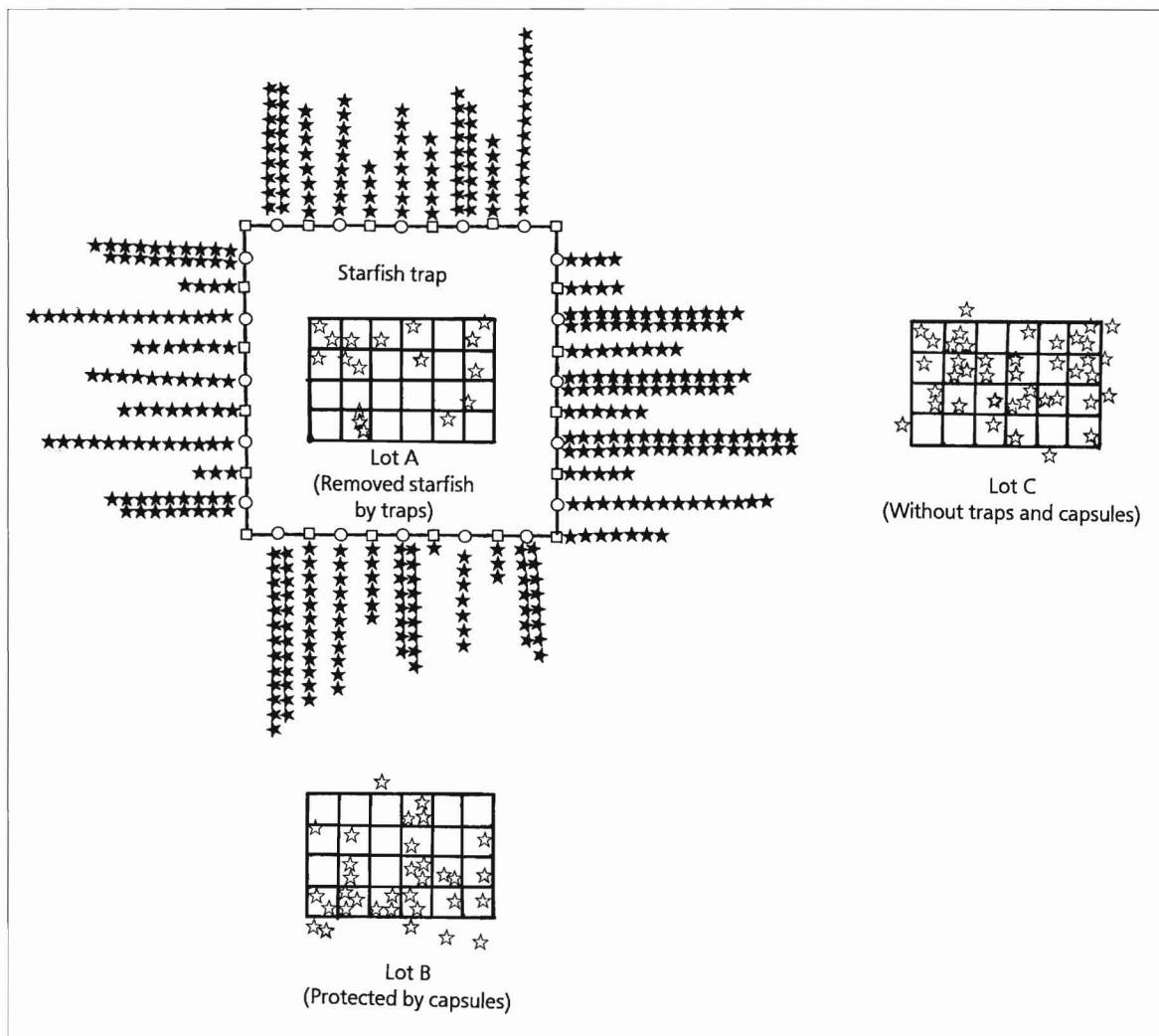
Composition of total weight of blood ark shell after five months of culture at six stations in Kasado Bay. Within the three groups of two stations each, data for 23 May 1984 are shown in bottom graph, data for 24 October 1984 are shown in upper graph (Umezawa et al. 1985).  $n$ =number of specimens.

Figure 7 shows the survival rate of blood ark shell in these experiments from May to October. During May to the middle of July, 1-year-old shell mortality is presumed to result from starfish predation because the size of starfish caught in this period was large enough to prey upon the blood ark shells. After the middle of July, the decrement in survival rate was not dependent on starfish predation because all of the experimental lots experienced almost the same decline in survival. Two- and 3-year-old shells have no need for prevention from starfish predation because the control experiment indicated a high survival potential for older shells.

When blood ark shells are released, those over 2 years old need no protection from predation. However, 1-year-old shells are still vulnerable to predation at release time, such that about 30% survival can be expected even when methods to prevent starfish predation are used.

### Plan against High Mortality in the Summer

From summer to early autumn, a high mortality of farmed 1-year-old shell has occurred frequently. The



**Figure 4**

Configuration of experimental system to prevent starfish predation on blood ark shells during 14 May to 27 November in 1985. Each ★ indicates an individual starfish removed by a trap. Each ☆ indicates an uncaptured starfish in the study area. □ indicates a type-I starfish trap and ○ indicates a type-II trap as shown in Figure 5 (Takami and Koumoto 1986).

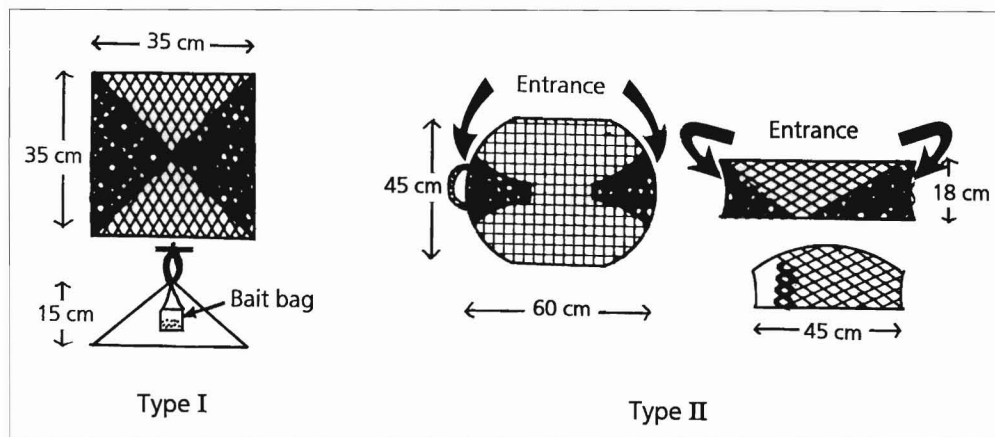
cause of this mortality is estimated to be the effect of high water temperature, low dissolved oxygen or increased sulphide levels (Ishida et al. 1977; Hamamoto 1981; Umezawa et al. 1984). It is important to avoid this high mortality during the cultivation of blood ark shell stock.

High-density hanging cultures with lantern nets were tested to counter high mortality in the summer (Umezawa et al. 1987). One hundred artificially cultured blood ark shell seeds were maintained in each of the four lantern nets, which were hung at a depth of 10 m in the sea. Four cage cultures, each of which had 50 seeds, were placed on the sea bottom. From May to October, the high density hangings achieved high survival rates of 94–100% compared with those

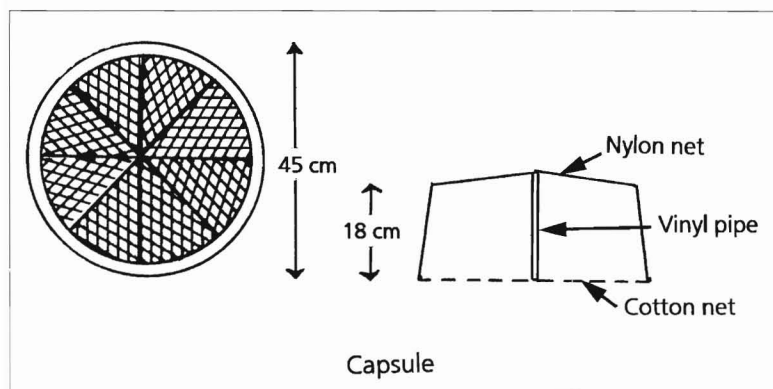
of cage cultures of only 8–32% (Table 1). Thus, high-density hanging is useful for avoiding high mortality in summer. This method has been repeated successfully for several years (Umezawa et al. 1987).

### Sexual Maturation of Planted Broodstock

Table 2 shows histological observations of gonad development in blood ark shells cultured from planted seed in Kasado Bay for one to three years (Numaguchi et al. 1985). The phases of gonadal development are divided into five stages: stage I, immature or sex unknown; stage II, early develop-



**Figure 5**  
Structure of traps designed to remove starfish in lot A (Takami and Koumoto 1986).



**Figure 6**  
Structure of capsule to protect ark shell from predation of starfish in lot B (Takami and Koumoto 1986).

ment; stage III, late development; stage IV, mature or spawning; and stage V, after spawning. One-year-old shells do not mature in the first year. All 2-year-old shells were immature in May—some male gonads developing after June. As for females, only one individual matured in October. Three-year-old shells did not mature in May. After June, the gonads developed in both males and females, and from August to September many individuals reached the spawning phase. The spawning season is estimated to range from July to September and the peak season is assumed to be from late August to early September.

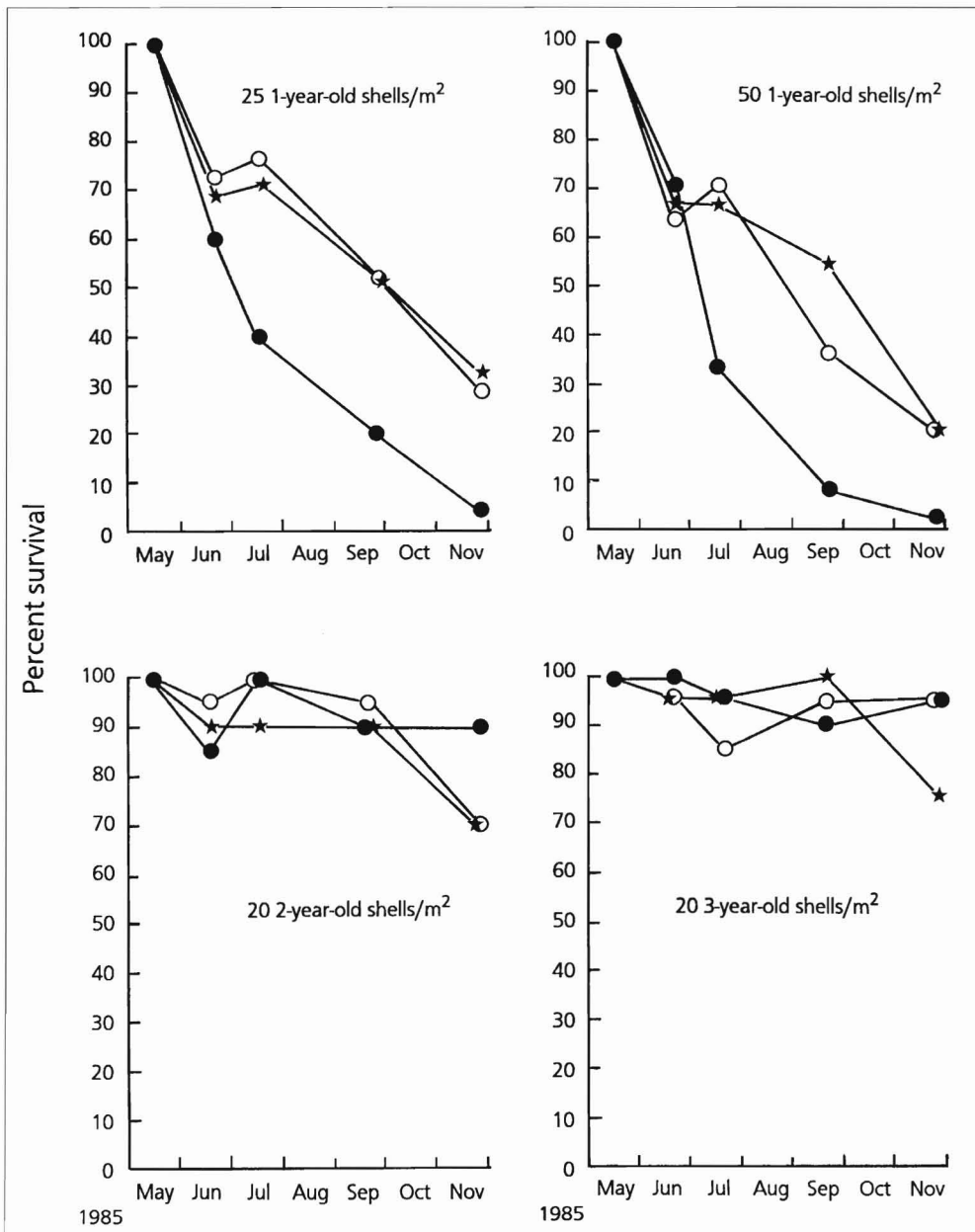
Table 3 shows the estimated egg number for 10 3-year-old parents. Three-year-old shells, which range from 65 to 75 mm in shell length and from 77 to 91 g in total weight, hold from 0.5 to 12 million eggs, averaging 5.5 million per individual.

### Larvae and Spats Collection from the Natural Environment

In order to know the period, distribution, and number of larval blood ark shells, Norpac-net tows were conducted at six stations in Kasado Bay and six stations in the coastal waters off Hikari close to the east side of Kasado Island (Takami and Koumoto 1987).

Eight species of bivalve larvae were collected in Kasado Bay, and 11 species were collected off the Hikari coast. Figure 8 illustrates the number of ark shell type larvae at Kasado Bay and Hikari. There were two species of ark shell (*Scapharca broughtonii* and *S. subcrenata*), but neither species could be specifically identified by larval examinations. In Kasado Bay, 3.1 individuals/m<sup>3</sup> of ark-shell type larvae appeared in late July, and fewer were collected in September and October. Off the coast of Hikari, 2.0 individuals/m<sup>3</sup> were present in July and August, rising to 15.3 individuals/m<sup>3</sup> in late September.

Two types of seed collectors, the hanging and bottom types, were set at two stations in Kasado Bay and one station off the coast of Hikari (Takami and Koumoto 1987). Hanging seed collectors consisted of a lantern net containing used fish net or nylon net. Bottom seed collectors which were located on the bottom hung the same lantern net by means of an iron frame (Fig. 9). Figure 9 shows the number of blood ark shell spat deposited on the two types of seed collector. In the hanging type collector, more blood ark shell spats are deposited as water depth increases. The number of spats deposited in the bottom type is greater than that of the hanging type. Spats collected in mid-December measured 1–6 mm in shell length, indicating that the larvae appeared



**Figure 7**  
Survival rate of blood ark shell by age and density from experiments to prevent starfish predation. Open circles denote lot A where two types of starfish traps were used; closed stars denote lot B where shells were protected by a capsule; closed circles denote lot C where seed were released without the protection of traps or capsules (control) (Takami and Koumoto 1986). The figures in each graph shows initial shell density.

and attached onto the collector from late September to October.

These larval and spat collection results were obtained in the investigation for 1986. The origin of these spats was probably derived from the natural population because the planted broodstock in Kasado Bay was still immature in 1986. The results of an identical investigation conducted in 1987 (Ouhashi and Koumoto 1988), showed marked improvement in the number of the ark shell type larvae compared to the previous year. These findings suggest that some fraction of collected larvae were spawned from the planted blood ark shell parents. However, the number of deposited spats in the seed

collectors were smaller in 1986, indicating that spat collection is a major problem to be solved at the pilot scale.

**Citation**

Hamamoto, S.  
1981. Basic studies on the mortality factor and resisting power of an ark shell, *Scapharca broughtonii* (SCHRENCK). Scientific Report of Kagawa Prefectural Fisheries Experimental Station 18:1-19. (In Japanese.)  
Ishida, M., I. Hayashi, and H. Ushima.  
1977. Experiment on cage culture of blood ark shell. Annual Report of Fukuoka Prefectural Buzen Experimental Station 49-52. (In Japanese.)

**Table 1**

Comparison of growth and survival between high-density hanging cultures in lantern nets and cage cultures on the sea bottom in 1986 (Umezawa et al. 1987).

Date	High-density hanging culture		Cage culture at bottom	
	No. of shells/net	Mean total wt. (g)	No. of shells/net	Mean total wt. (g)
May 13	100	6.8	50	8.1
	100	6.9	50	7.3
	100	6.8	50	7.1
	100	6.8	50	6.1
	100	7.0		
Oct. 13	98	23.6	14	16.4
	94	25.6	16	15.6
	100	23.8	9	15.4
	97	20.7	4	12.1

**Table 2**

Frequency (%) of blood ark shells in each phase of gonad development in 1- to 3-year-old shells in 1984 (Numaguchi et al. 1985). Stages I-V are phases of gonad development: Stage I, immature or sex unknown; Stage II, early development; Stage III, late development; Stage IV, mature or spawning; and Stage V, after spawning.

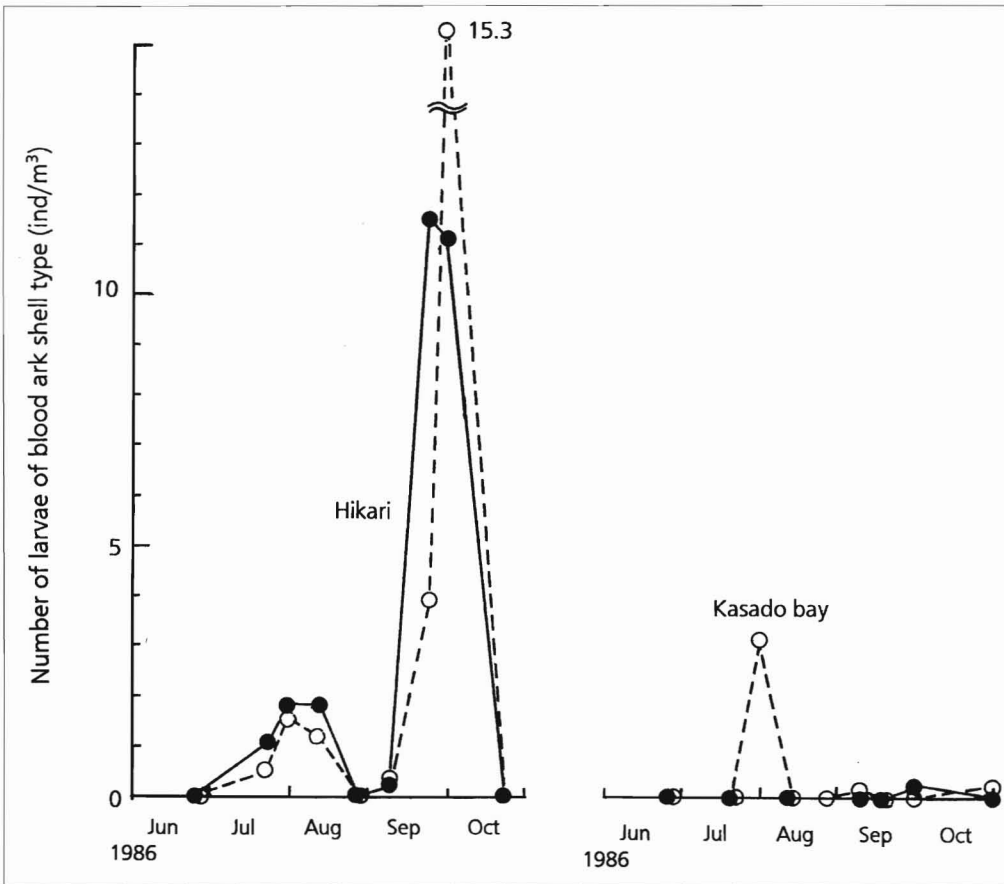
Sampling date	1-yr-old					2-yr-old					3-yr-old						
	I	II	III	IV	V	I	II	III	IV	V	I	II	III	IV	V		
	♂	♀	♂	♀	♂	♀	♂	♀	♂	♀	♂	♀	♂	♀	♂	♀	
May 23	100	0	0	0	0	0	0	0	0	0	0	0	0	0	0	0	0
Jun 5	100	0	0	0	0	0	0	0	0	0	85	15	0	0	0	0	0
Jun 25	100	0	0	0	0	0	0	0	0	0	55	45	0	0	0	0	0
Jul 4	100	0	0	0	0	0	0	0	0	0	55	15	0	15	0	0	0
Jul 24	100	0	0	0	0	0	0	0	0	0	35	55	0	10	0	0	0
Aug 20	100	0	0	0	0	0	0	0	0	0	90	10	0	0	0	0	0
Sep 17	100	0	0	0	0	0	0	0	0	0	55	45	0	0	0	0	0
Oct 31	100	0	0	0	0	0	0	0	0	0	80	0	0	0	0	0	10

**Table 3**

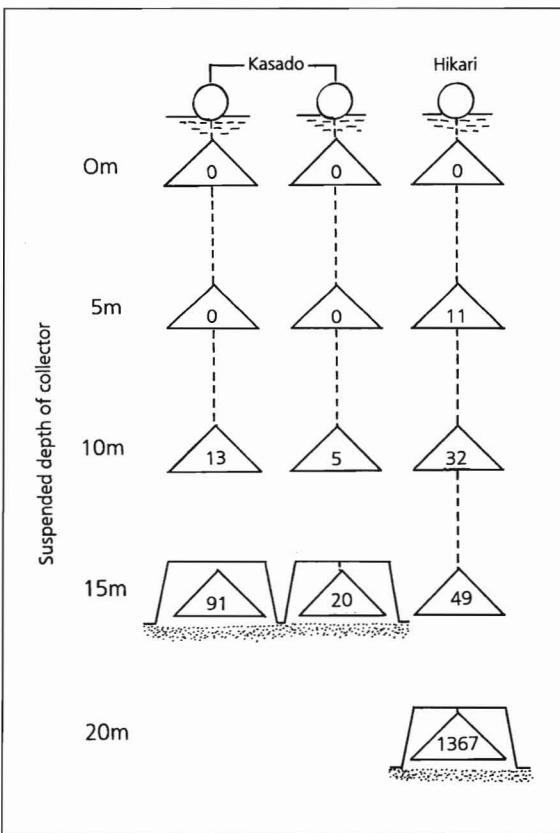
Shell length, weight and egg number of 3-year-old blood ark shell (Numaguchi and Tanaka 1987).

Sampling No.	Shell length (mm)	Weight (g)		No. of eggs ( $\times 10^5$ )
		Meat	Gonad	
1	71	78	0.36	5.4
2	77	87	0.86	7.1
3	71	81	1.59	16.1
4	67	70	1.93	54.0
5	70	80	2.89	5.5
6	70	77	3.51	70.6
7	66	86	3.72	76.5
8	65	88	4.09	115.5
9	75	91	5.25	78.9
10	72	86	5.97	119.3
Average	70	82.5	3.02	54.9





**Figure 8**  
 Seasonal distribution of ark shell type larvae at Kasado Bay (water depths are about 15 m) and the coastal waters off Hikari (water depths are about 20 m) as collected with a Norpac net. ○ = mean tows from all depths combined at each of six stations. ● = mean for the middle of water depth to upper layer (Takami and Koumoto 1987).



**Figure 9**  
 Number of blood ark shell spats deposited in seed collectors at different depths in Kasado Bay and off the coast of Hikari. Numbers in the triangles predict the total spat number of 21 hanging cages. Those with frames predict the total spat number of 12 cages located on the bottom (Takami and Koumoto 1987).

- Numaguchi, K., and Y. Tanaka.  
1987. Acceleration technique of maturation and spawning of the ark-shell, *Scapharca broughtonii*, in farming ground. Marine Ranching Project Progress Report, Bay Scallop and Blood Ark Shell 7:55-59. (In Japanese.)
- Numaguchi, K., S. Funakoshi, and K. Wada.  
1985. Maturation and spawning of cultured ark shell, *Scapharca broughtonii*. Marine Ranching Project Progress Report, Bay Scallop and Blood Ark Shell 5:71-75 (In Japanese.)
- Ouhashi, H., and Y. Koumoto.  
1988. Technique for collecting ark-shell seed from artificial broodstock. Marine Ranching Project Progress Report, Bay Scallop and Blood Ark Shell 9:73-83. (In Japanese.)
- Takami, T., and Y. Koumoto.  
1986. Studies on the artificial propagation and control of the predators in the ark shell. Marine Ranching Project Progress Report, Bay Scallop and Blood Ark Shell 6:97-106. (In Japanese.)
1987. Technique for collecting ark-shell seeds from artificial broodstock. Marine Ranching Project Progress Report, Bay Scallop and Blood Ark Shell 7:61-72.
- Umezawa, S., K. Nogami, and O. Fukuhara.  
1984. Relation between high mortality and some environmental conditions for ark shell, *Scapharca broughtonii* in cage culture. Bull of the Nansei Regional Fisheries Research Laboratory 16:231-244. (In Japanese.)
1985. Environmental conditions and releasing density of ark shell in the artificial farming ground. Marine Ranching Project Progress Report 5:57-69. (In Japanese.)
- Umezawa, S., S. Arima, K. Oochi, and O. Fukuhara.  
1987. Farming the broodstock and environmental conditions for natural seeding of ark-shell. Marine Ranching Project Progress Report, Bay Scallop and Blood Ark Shell 7:73-81. (In Japanese.)

# The Marine Ranching System: The Integration of Biology and Engineering Technology

HIROYUKI NAKAHARA

*Research Institute for Ocean Economics  
Marufuji Bldg., 3-1-10 Shinbashi  
Minato-Ku, Tokyo 105, Japan*

## Abstract

This paper discusses a variety of concepts concerning aquaculture, including fish-farming and marine ranching with respect to their purpose, the ownership of the fish, participants, the ability to measure resource production, the technologies introduced to date, and future trends. Approaches to engineering systems, which should be designed to meet with the biological aspects, are also examined along with some examples. Aquaculture, which used to be deployed in rather small, calm and protected bay areas, needs improved hardware and techniques in order to be performed in more offshore areas on a larger scale. The expansion of fish farming should be accompanied with new environmental control technologies: technologies designed to enhance primary production and other related engineering capabilities. To integrate the efforts of biologists and engineers is the best way to create a successful marine ranching system. Some of the experiences reported in this paper are based upon research and development activities. For example, seabed improvement efforts have been made which make use of civil engineering and water quality improvement to fit the needs of a target species during a certain stage of its growth to enhance feeding. This was done by making use of water movement control technologies and by introducing new materials and structures for the attachment of food organisms.

## Introduction

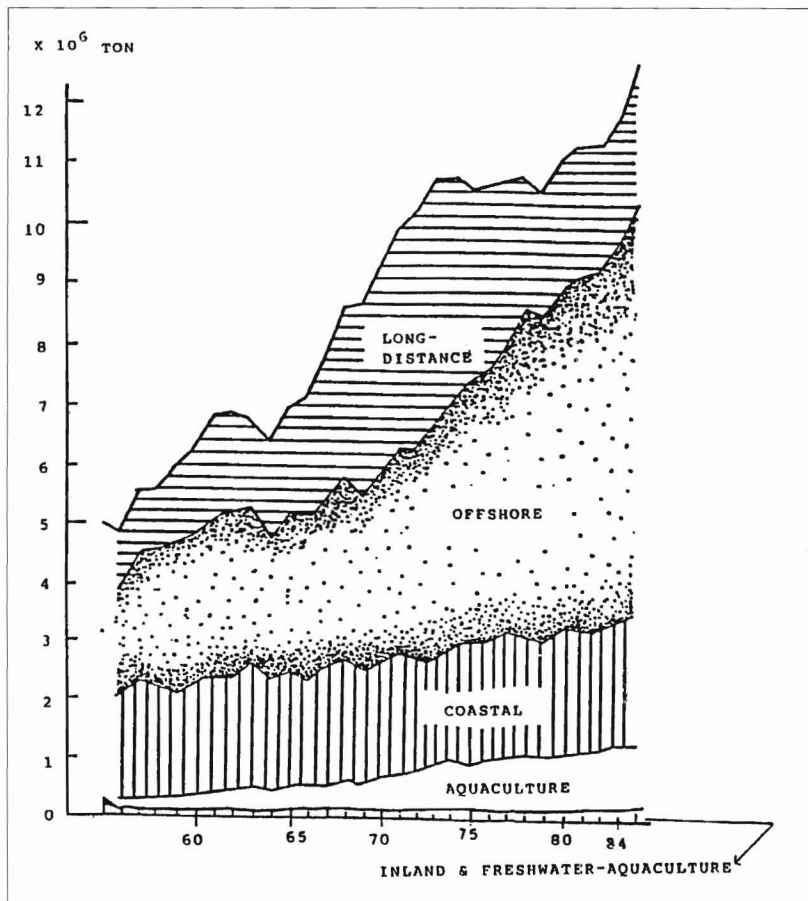
---

Japan is the largest fishing nation in the world with a total catch in 1985 of 12.2 million tons (JFA 1987; MAFF 1987). Additional fishery products valued at about five billion dollars were imported while exports totalled one billion dollars. Because the local offshore fishery in the waters around Japan consists mainly of sardines and because growing international constraints are making contributions from long-distance fishing harder to maintain, efforts are focusing on coastal fishery production to keep up with the growing demand for high-quality fishery products.

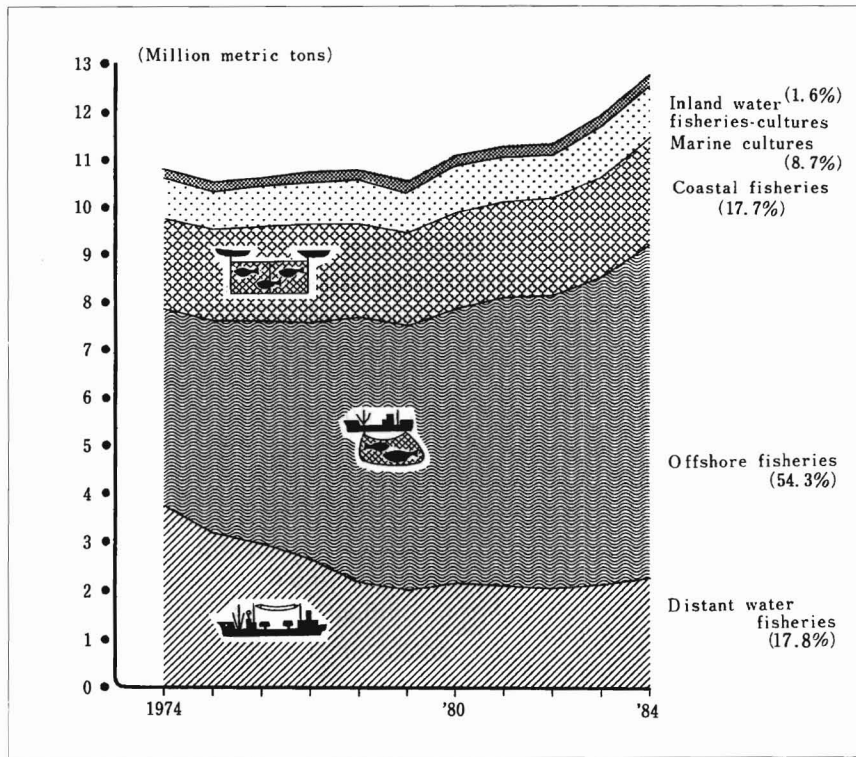
The coastal fishery production increased from 2.24 million tons in 1965 to 2.71 million tons in 1975, and to 3.36 million tons in 1985. However, within these totals, the percentage from fishing boats, the traditional style of harvest, remained constant at around 2 million tons during these twenty years. The increases were realized by the marine net-pen fishery and aquaculture. (Figs. 1 and 2; DSI 1984) The contribu-

tion from aquaculture has risen five times during this period. Sea-farming, which refers primarily to the propagation of cultured seed that are released into the natural environment, has been performed for more than twenty years. Typical of this effort is the release of two billion chum salmon (*Oncorhynchus keta*). The mass production of other seed is now possible with kuruma prawn (*Penaeus japonicus*), blue crab (*Portunus trituberculatus*), scallop (*Patinopecten yessoensis*), abalone (*Haliotis discus hannai*), and others.

Based upon these cultivation activities, the new concept of The Marine Ranching System has been developed in recent years, which makes use of industrial engineering technologies (RIOE 1981-88). Some of them are in a very conceptual stage while others are being experimentally executed on-site. This paper described the status quo of these efforts in Japan, which are combining biological knowledge with engineering technologies.



**Figure 1**  
Trends of fishery production in Japan (Fisheries Statistics of Japan, Ministry of Agriculture, Forestry, and Fisheries 1984).



**Figure 2**  
Total catch by type of fishery, 1974-84 (Fisheries Statistics of Japan, Ministry of Agriculture, Forestry, and Fisheries 1984).

## Definition of Aquaculture, Sea-farming, and Marine Ranching

Throughout the long history of mankind, fishing has meant the taking of live fish from the sea in a manner analogous to hunting on land. In the past, we caught more fish from the sea by sailing all over the world using high-tech electronic instrumentation. Conversely, we are now developing aquaculture techniques that are analogous to cattle breeding. In Japan, both freshwater and marine aquaculture have been developed for a long time. Carp (*Cyprinus carpio*), eel (*Anguilla japonica*), chum salmon (*O. keta*), rainbow trout (*O. mykiss*), and sweetfish or Ayu (*Plecoglossus altivelis*) are the major species cultured in freshwater. Marine aquaculture mainly covers laver (*Porphyra*), oyster (*Crassostrea gigas*), yellowtail (*Seriola quinqueradiata*), sea mustard (*Undaria*), scallop (*Patinopecten yessoensis*), and red seabream (*Pagrus major*).

## Aquaculture

The term "aquaculture" generally means the cultivation of fish in the protected sea area and is frequently symbolized by the net-cage (Fig. 2). This process usually starts with the collection of eggs from either natural or artificial environments, then rearing the juveniles, usually with feeding until harvest time. The most important characteristics of aquaculture are 1) that the ownership of fish is quite clear, 2) that human control is possible throughout the whole life of the fish although conditions within the net cages are supported by nature, and 3) that the final fruits of the production are countable (Table 1).

## Sea-Farming

Sea-farming involves the propagation of cultured seeds and fry into adults and their release into the

**Table 1**  
Major characteristics of aquaculture and fish-farming in Japan.

	Aquaculture	Fish-farming
Sector	Private	Public
Major species	Laver ( <i>Porphyra</i> ) Oyster ( <i>Crassostrea gigas</i> ) Yellow-tail ( <i>Seriola quinqueradiata</i> ) Scallop ( <i>Patinopecten yessoensis</i> ) Red Seabream ( <i>Pagrus major</i> )	Salmon ( <i>Oncorhynchus keta</i> ) Red seabream ( <i>Pagrus major</i> ) Kuruma prawn ( <i>Penaeus japonicus</i> ) Yezo abalone ( <i>Nordotis discus hannai</i> ) Flounder ( <i>Paralichthys olivaceus</i> )
Area	Protected sea	Open sea
Purpose	Direct production	Resource increase
Human control	Total period (until harvesting)	Until releasing
Ownership	Fish producer Net cage owner	None
Bait	Feedable	Non-feedable (food organism in nature)
Production	Countable	To be included in total catch (by traditional fishing operation)
Technology	Net cage structure Formula feed	Seeding production Tagging Artificial reef
Future trend	Larger Deeper More offshore Biotechnology	Survival rate improvement Environmental control Primary production enlargement Biotechnology

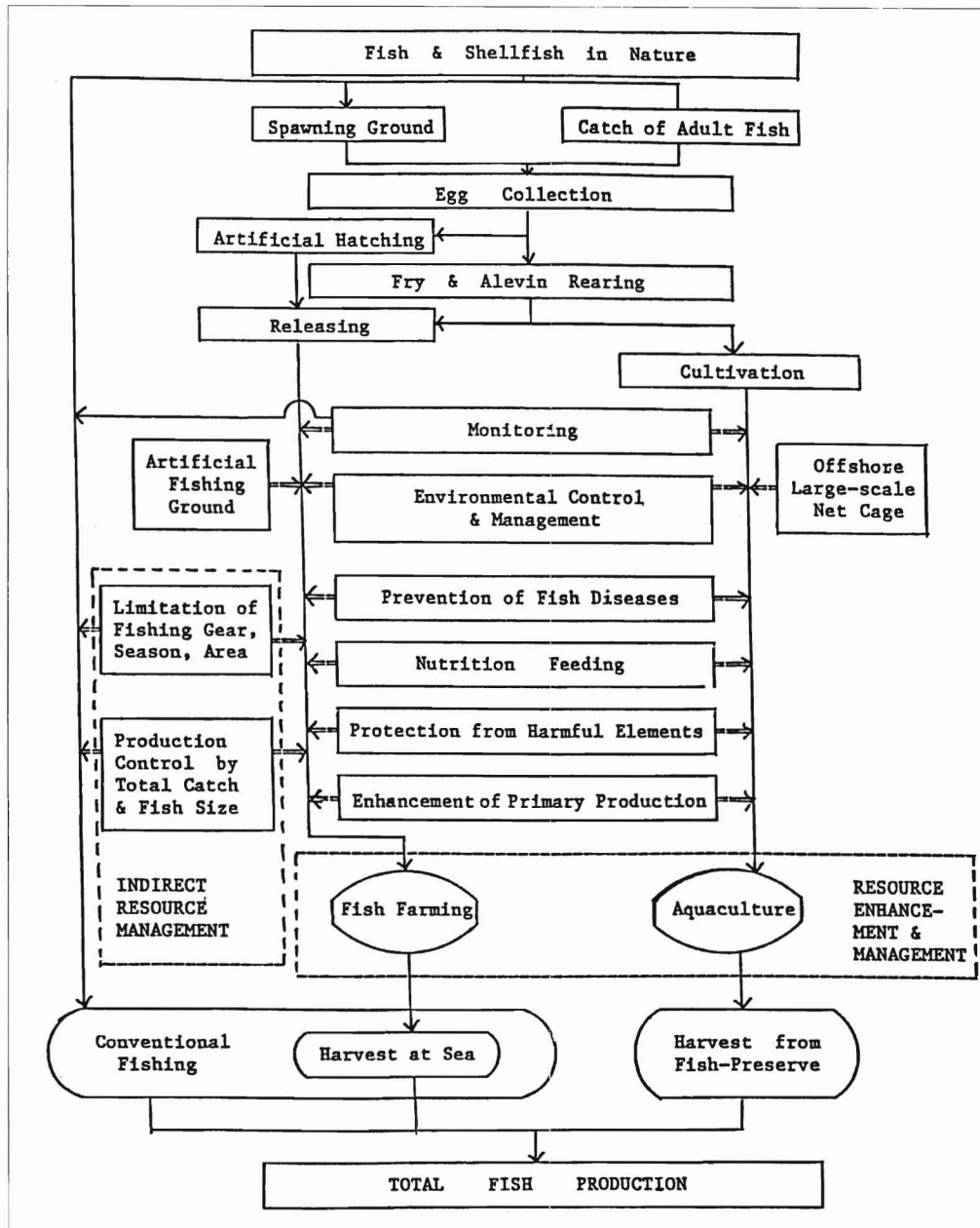


Figure 3  
Concept of the Marine  
Ranching System (Research  
Institute for Ocean Eco-  
nomics).

sea. Obviously they cannot be counted except when they are tagged.

Released fish belong to no one individual, instead they contribute to the increase of the fishery resources and can be harvested by anyone. For this reason, sea-farming is done by the public sector in Japan. This type of cultivation is highly dependent on the carrying capacity of the natural sea itself. Compared with aquaculture, human measures to improve their growth in the natural environment have had a rather limited effectiveness and the artificial reef is almost the only one effective method among them. The final product of sea-farming is included in the total number of fish caught by the traditional fishing operations. In the case of chum salmon, it is easy to detect the contribution of this human effort whereas

in other species it is quite difficult to assess the effectiveness quantitatively.

Both aquaculture and sea-farming are considered vital parts of the marine ranching system, but when we discuss their use in this program, we are speaking of projects that are technically upgraded in various perspectives. In the case of aquaculture for example, the near future may bring the use of a netless caging system, which utilizes acoustic, optical or some other advanced technology. Moreover, large floating structures to hold net cages of required size and numbers, may be used to create offshore preserves which can be moved if necessary.

Sea-farming also needs to step into a new age with various environmental control technologies created for the system. We need multiple technologies from

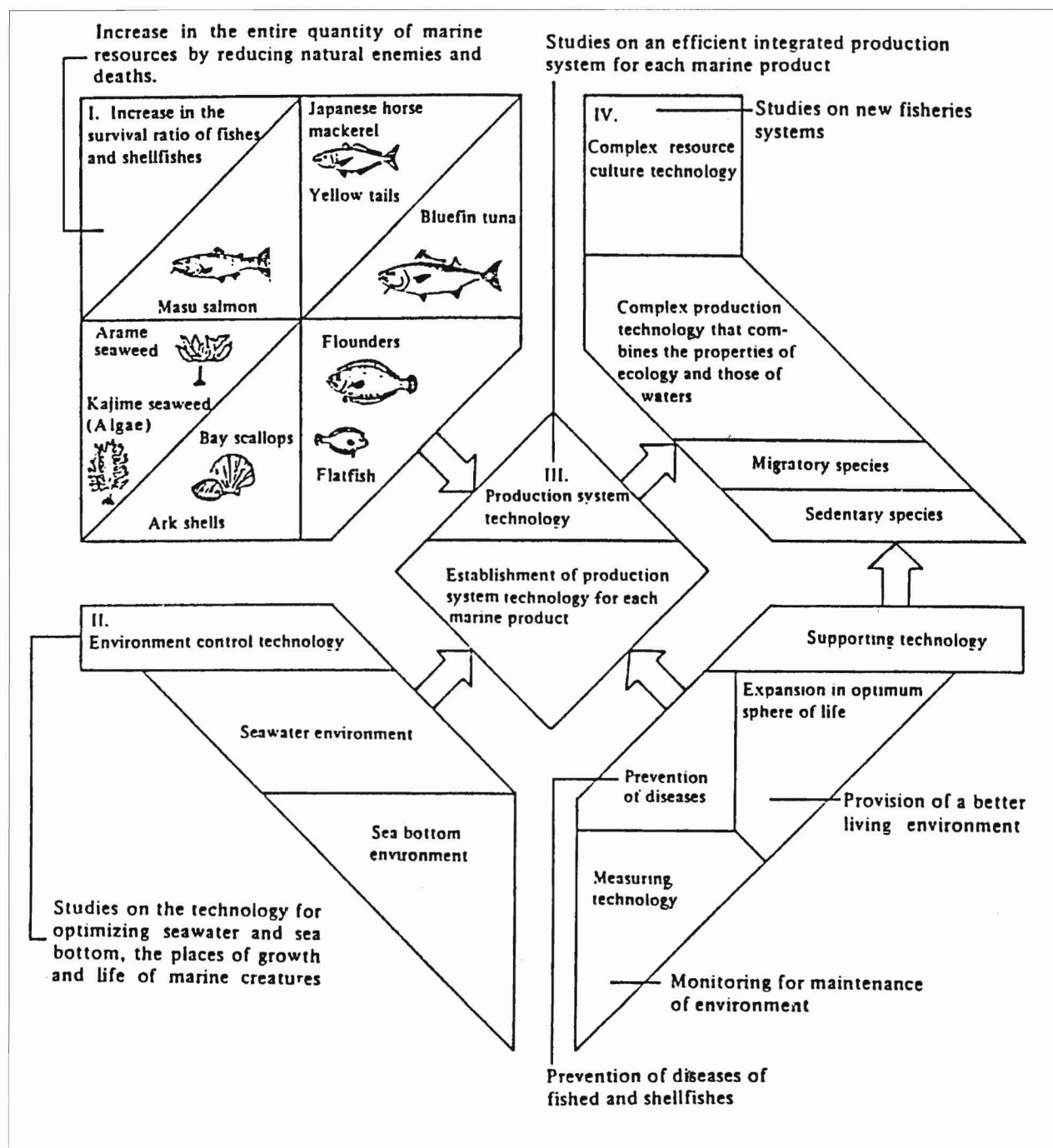


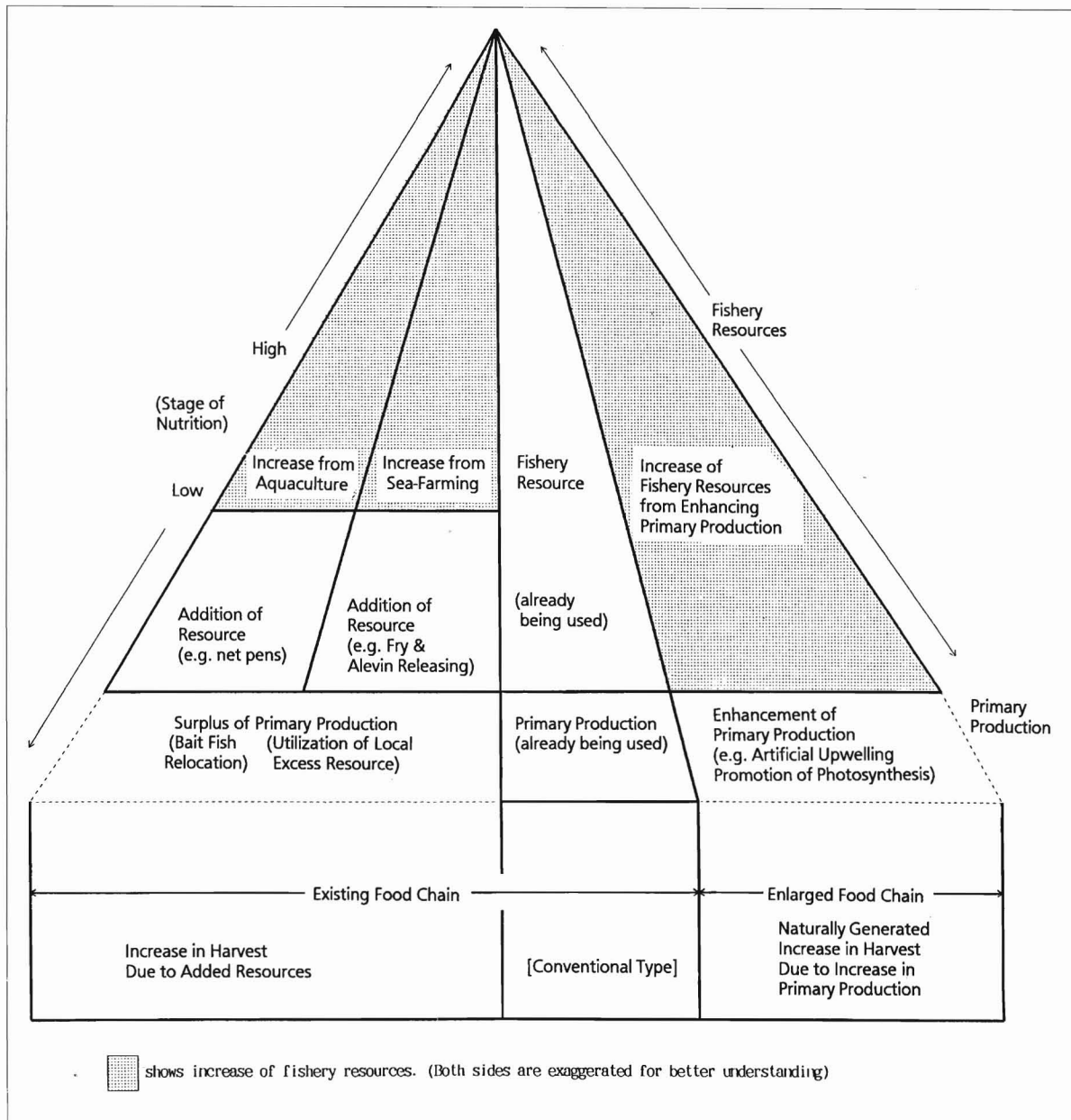
Figure 4

Flowchart illustrating the research of the Marine Ranching Program. (Research Council of Agriculture, Forestry, and Fisheries).

civil, mechanical, electric and other engineering disciplines to be developed by industrial communities outside of fisheries. Furthermore, to increase the seedling survival rates in the sea, biotechnology will be of great help in producing healthier seed than ever before. Of course the total system of marine ranching should be combined within the appropriate legal and social frameworks (Fig. 3).

### Marine Ranching Program

In the government sector, the Research Council of Agriculture, Forestry and Fisheries, collaborating with the Fisheries Agency and its national fishery research institutes, started a 9-year research program, called the "Marine Ranching Program" (MRP), in 1980. During the first 3 years, the ecological study of

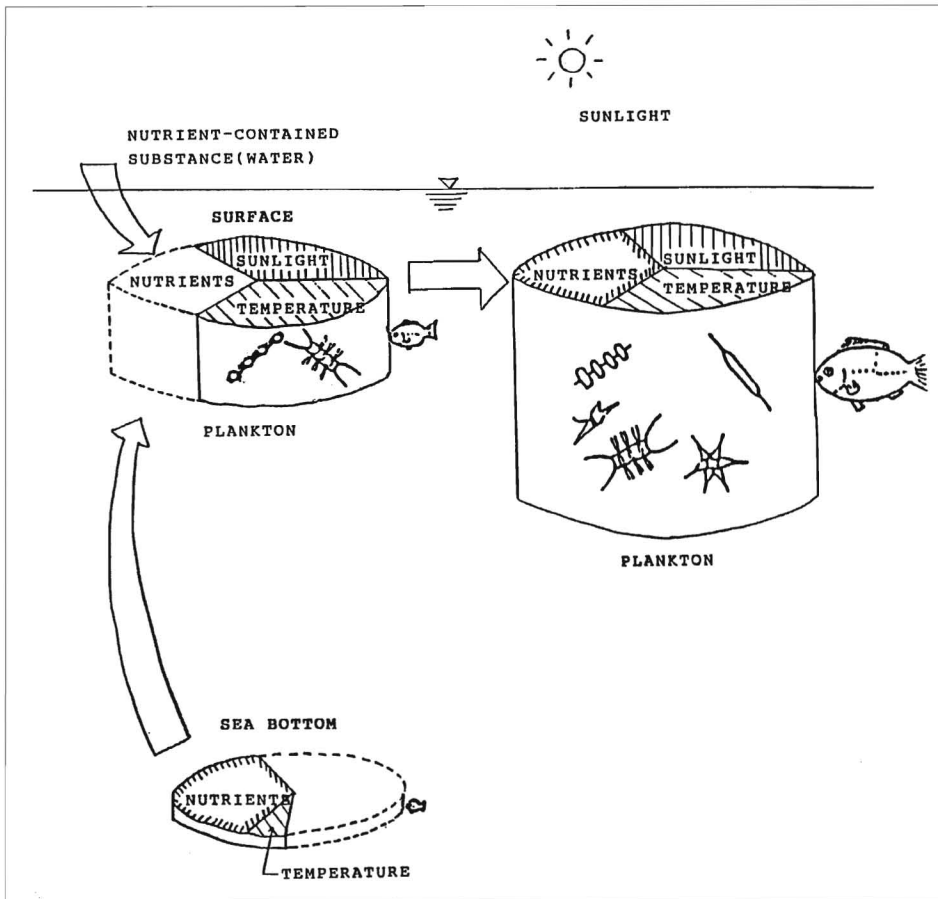


**Figure 5**  
Structure of the marine food chain.

various target species and preliminary study on environmental control and disease prevention were executed. The second 3-year period was devoted to the study of production systems, and the last 3 years to the examination of multiple-species ranching systems. The selected target species were masu salmon (*O. masou*), horse mackerel (*Trachurus japonicus*), bluefin tuna (*Thunnus thynnus*), flounder, bay scallops, and seaweed (along with abalone and others). Each represents a different pattern of life in the sea, thus covering the categories of highly migrating, open-sea migrating, nonmigrating, and sedentary

fish and algae (Fig. 4). This program has been done mainly by considering the biological aspects, but some study to integrate it with engineering technologies has also been done by a group studying the marine ranching system organized within the Research Institute for Ocean Economics (RIOE), a research institution which examines various ocean uses and development and to which the author belongs. The approach used for help identify engineering tasks within the marine ranching system examined by RIOE is described below.





**Figure 6**

Scheme of engineering on the key parameters of the food chain to enhance primary production (Research Council of Agriculture, Forestry, and Fisheries).

## Approach to the Marine Ranching System Engineering

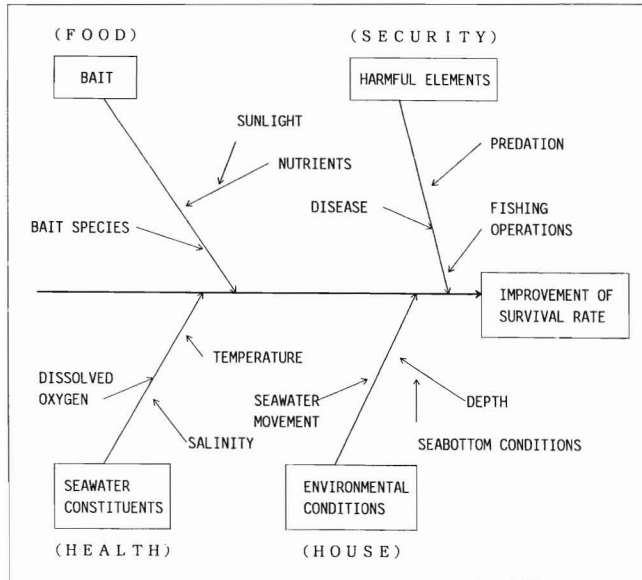
### Food Chain Scheme Approach

When we consider utilizing the sea's potential, or consider the addition of recoverable resources into it, a view from the perspective of the food chain offers us a suggestion. Such an effort involves expanding the pyramid shaped hierarchy of the food chain as shown in Figure 5. To better understand the diagram, it should be kept in mind that both sides of the pyramid structure have been exaggerated somewhat.

The right hand side shows that artificial measures should be taken in order to increase primary production by making use of the unused but potentially valuable resources of the sea. One idea is to pump up nutrient-rich deep-sea water to certain sea areas, such as semiclosed bays and thus form an artificial upwelling system. Another idea is to transmit sunlight into the dark lower layer of the sea to activate photosynthesis. These ideas are creating great challenges which can only be solved with new engineering technologies. They are based upon the basic concept that

the nutrients and the sunlight are among the critical factors which create optimum environmental conditions (Fig. 6) as described in below.

The left hand side of Figure 5 shows a direct approach to increasing resources by adding them directly into the sea. Aquaculture represents this approach of adding the new resource into a manageable sea area so that all the added resource can be harvested. In the case of yellowtail, for example, the feeding bait is sardine which represents the fruits of primary production somewhere else in the sea. In this approach, engineers may focus on the development of large scale structures to support fish cages which must be strong enough to cope with the harsh environment of the deeper, more offshore sea areas. The direct release of resources to the sea is another type of approach. In this case, we expect that a portion of the added resource will be harvested in the future by conventional fishing operations. This represents sea-farming, namely, the propagation and release of juveniles. The natural environment supports this enhancement scheme if we assume that the existing carrying capacity is sufficient. In this case, less effort has been necessary from the engineering community.



**Figure 7**

Critical factors for the improvement of survival of marine resources.

### Critical Factors Approach

When we turn our eyes to the vital elements, or critical factors for fish growth and survival, we find that several important factors can be controlled by human beings to some degree. In the case of chum salmon, a migratory species, the production increases have been made by accumulating fingerling releases over many years without the use of additional specific artificial measures to control environmental factors. This success therefore, must also have been supported by a combination of favorable conditions like the abundance of food sources in the northern Pacific Ocean, the rather small number of harmful elements, and the mobility resulting from the swimming capacity of this species.

However, when we consider nonmigratory and sedentary species, the effect of predators and environmental factors are much more influential on the survival rate, especially during the juvenile stage. The critical factors for the survival of a fishery resource depends upon the species and its stage of growth. In addition, when we discuss engineering approaches, some basic considerations can be given by making analogies with the lives of the human beings. At the very least, we need food to eat, good health to grow, a house in which to sleep, and security to live. The corresponding factors for fish are bait to eat, security from predators, and a comfortable chemical and physical environment (Fig. 7).

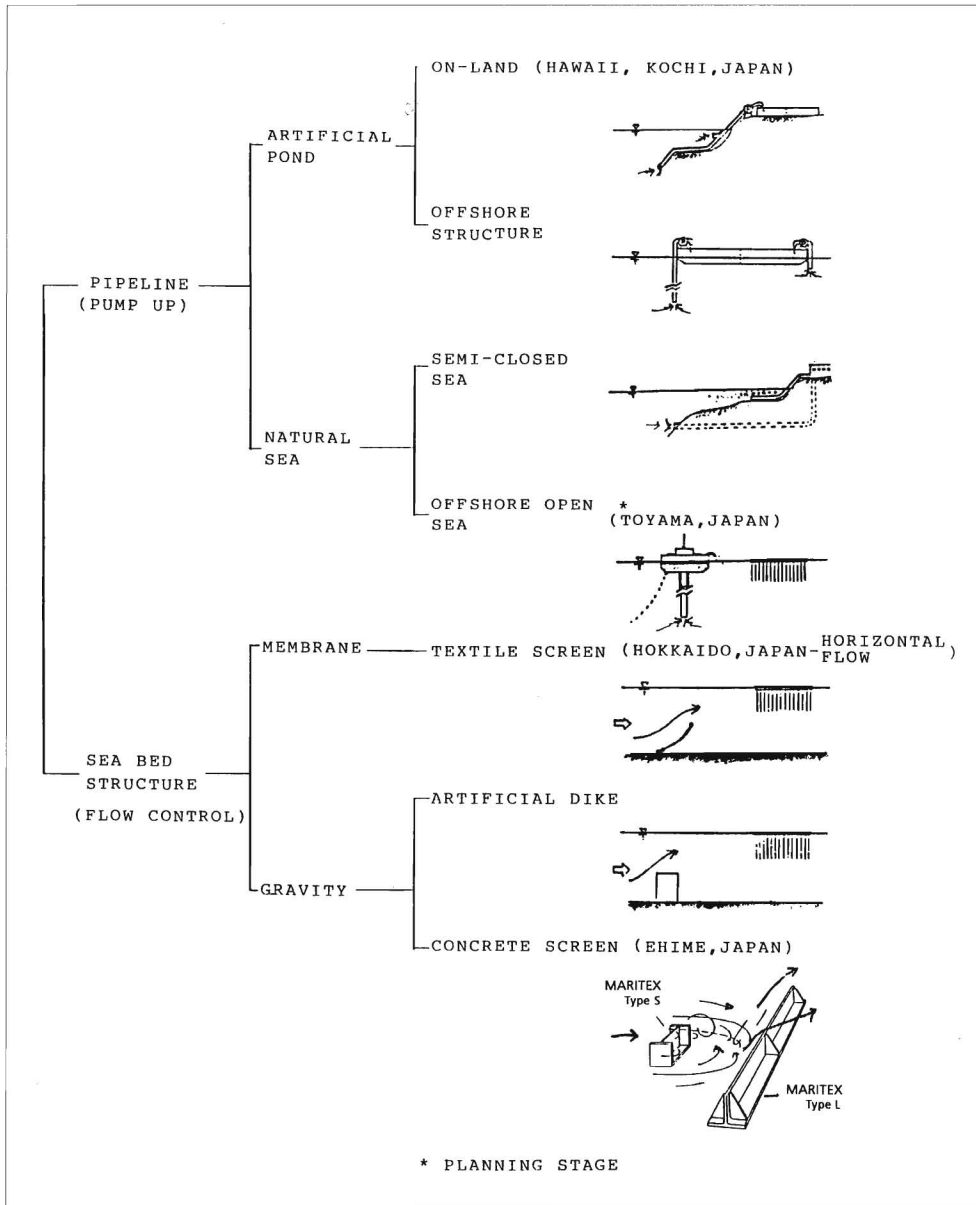
Engineering can control the level of nutrients and sunlight for baitfish. In addition, they can put improve security from predators by controlling environmental conditions or by changing the predators' attention to other attractive things. Environmental conditions such as water movement, and seabottom conditions can be managed by civil and mechanical engineering technologies, to create favorable environmental conditions for juvenile fish.

### Variations of Artificial Upwelling System

Various artificial upwelling technologies are illustrated in Figure 8. Among these is a land-based system using pumped up nutrient-rich, deep seawater, which is already operating in Hawaii. This system is also well known as a part of OTEC (Ocean Thermal Energy Conversion), which generates electricity by using the temperature difference between surface and deep seawater. We can therefore put the deep water not only in the natural sea area but also in artificially made ponds, and land-based tanks as has been done in Hawaii. In Japan, a similar system exclusively for the cultivation of fish will soon start near Cape Muroto in Kochi prefecture.

Another unique system utilizes deep water pumped up to a surface barge. Partly intended for the direct use of the nearby net cages which are attached to the barge, its primary purpose is to supply a sprinkler system which disperses the pumped up water onto the surface to bolster primary productivity and baitfish abundance in the area. Designed to be completed within a couple of years in the Toyama Bay, the system moderates the cold temperature of the pumped deep water taken from the depth of 300 m by mixing it with warm surface water.

Through this field test, the optimum ratio of cold deep water to warm surface water will be surveyed and its effectiveness to increase the fishery production will be estimated. The estimation index is one of the most important items to be examined. The bay has a steep seabed, is halfway closed by Noto Peninsula, and holds cold deep water rich in nutrients. This unique natural condition can only be seen in Toyama Bay along the Sea of Japan coast and in Suruga Bay along the Pacific coast. The Toyama Bay project should be of great interest from both the biological and the engineering point of view, although many difficulties exist, including the method of the assessment of its effectiveness. However, this challenging project is said to be the first attempt at an offshore floating-type upwelling system in the world. Seabed civil engineering systems are approaches un-



**Figure 8**  
Various artificial upwelling systems.

der development to control water movement. A horizontal method of flow control is being deployed experimentarily with a textile screen in the shallow water off Hokkaido. an artificial seabed dike, which makes use of the fly ash, is also under examination. Concrete seabottom structures which channel deepwater flow up to the surface have also been experimentally employed in Aomori prefecture on a small scale. In Ehime Prefecture a greater magnitude of scale was accomplished requiring a budget of hundreds of millions of yen. A rubber dike to create an artificial tideland is also being executed. Furthermore, subsurface structures for the creation of artificial seabeds that employ available sunlight are another idea promoting the multilevel utilization of the water column (Fig. 9). Many new materials previ-

ously unfamiliar to fishery-related people are being introduced among these efforts.

### New Materials

Materials are being introduced in the fishery-related efforts mentioned above, including fly ash, a by-product continuously produced by coal-fired power plants, and rubber, which most people equate with car tires. Quite unique, new materials are also being used for other marine ranching engineering. Two examples are described here. First is "Polyethhtel," which is used to construct a man-made seaweed-like tree. Used in combination with a concrete artificial reef, it upgrades the reef's attractiveness to marine life by

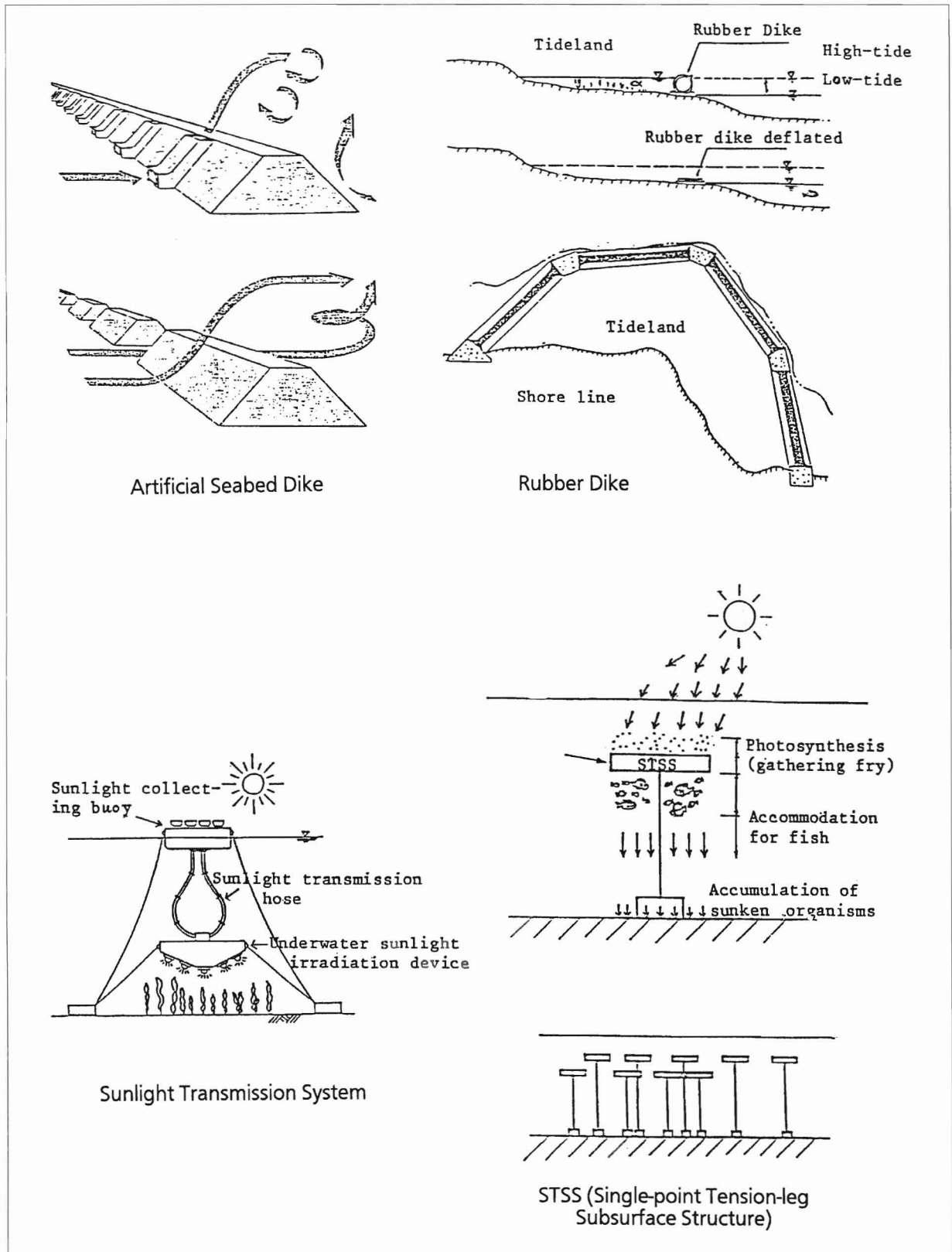
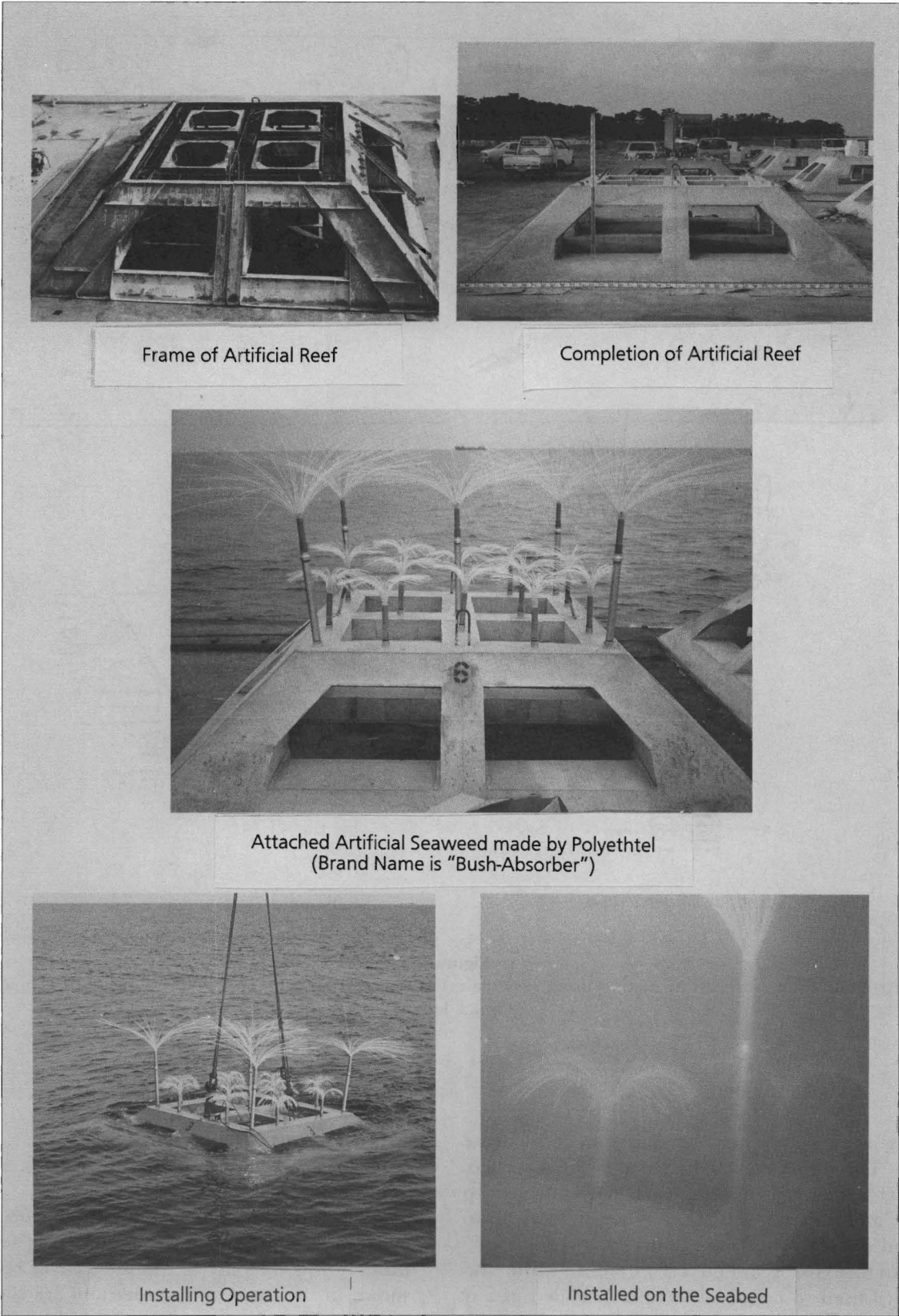


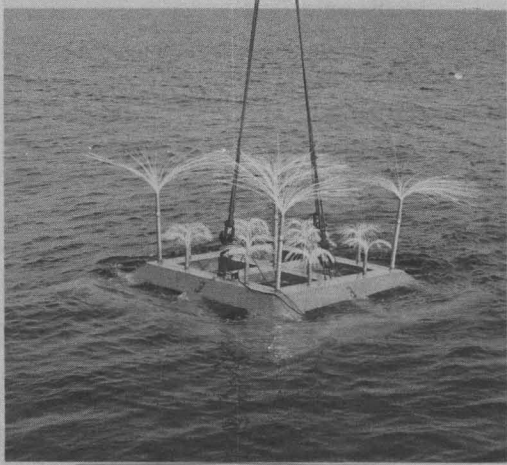
Figure 9  
Examples of marine ranching technologies.



Frame of Artificial Reef

Completion of Artificial Reef

Attached Artificial Seaweed made by Polyethtel (Brand Name is "Bush-Absorber")



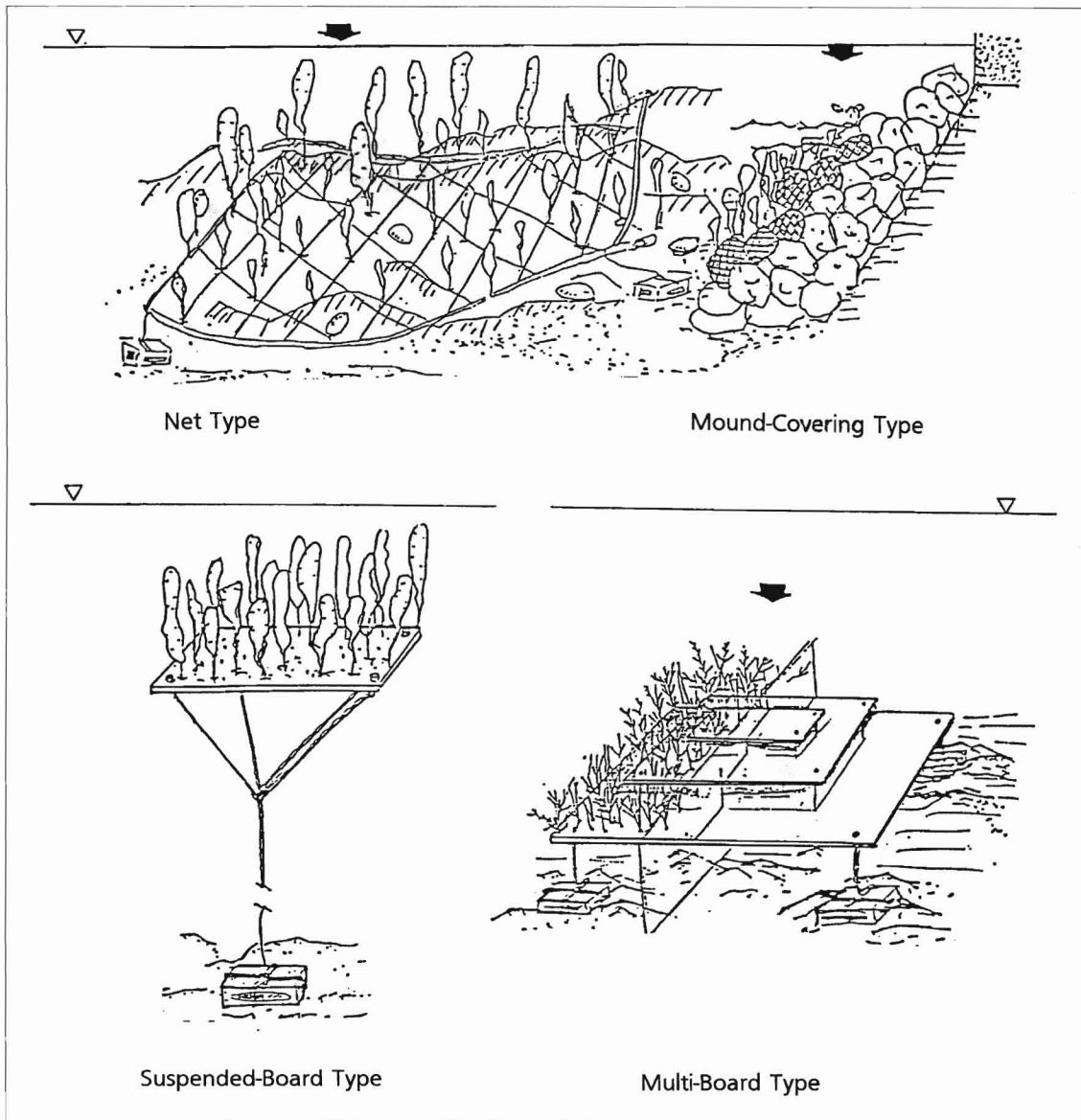
Installing Operation



Installed on the Seabed

Figure 10

Artificial seaweed forest formation using new materials (Wakachiku Construction Co., Ltd., Tokyo, Japan).



**Figure 11**

Artificial seaweed forest formation using new materials (Chateau Marine Survey Co., Ltd., Miyakojima, Osaka, Japan).

providing a substitute for the attachment of algae (Fig. 10). This effort was made five to eight years ago. The other example is a composite material of polyethylene and calcium carbonate that is made into twine and boards. The twine is used to weave a net-type structure for seaweed attachment, while the boards are used to create an artificial seabed at any depth. Any number of decks can be installed in mid-water by anchoring or pile fixing (Fig. 11). This new material was patented recently.

### Engineering Measures Based upon Biological Requirements

Two examples of the examination process used to model the development of engineering technologies which will contribute to the increase of resources are shown in the cases of flounder and ark shells (Tables 2 & 3). The charts seek to identify critical factors which determine survival, growth, and reproductive rates. During the transformation period of flounder

**Table 2**  
Basic idea of engineering measures upon biological requirements  
Flounder (*Paralichthys olivaceus*).

Life stage	Habitat		Flounder ( <i>Paralichthys olivaceus</i> )	Other species
	Seawater	Seabottom		
Larval (floating life)	Prevention of dispersion (by controlling seawater movement)	—	—	—
Juvenile (seabottom life)	(Same as above)	Improvement of seabottom condition	Supply of bait	Protection from predators
Adult	—	(Same as above)	(Same as above)	—
Spawning	—	(Same as above)	(Same as above)	—

**Table 3**  
Basic idea of engineering measures upon biological requirements  
ark shell (*Scapharca broughtonii*).

Life stage	Habitat		Flounder ( <i>Paralichthys olivaceus</i> )	Other species
	Seawater	Seabottom		
Floating	Prevention of dispersion (by controlling seawater movement to accumulate larvae)	—	Supply of bait	—
Attaching and transformation to sedentary type	(Same as above)	Formation of attaching structures	(Same as above)	Protection from predators
Seabottom	—	Improvement of seabottom condition	(Same as above)	—
Spawning	—	(Same as above)	(Same as above)	Protection from predators

from the floating life stage to the seabottom life stage, bait species change and water currents frequently disperse eggs and larvae to unfavorable seabottom conditions. Both are critical situations that affect the mortality of juveniles. These requirements, determined by biological study, suggest that engineering measures should be taken to control the seawater movement in order to prevent egg dispersion and to improve the seabottom condition. In the

case of ark shells, similar approaches could be considered.

## Conclusion

The planning and development of engineering technologies should basically be supported by biological studies, otherwise successful results can not be ex-

pected nor obtained. All aspects of the engineering must have a biological reason and endorsement. Even then, the engineering side must be always humble to accept the demands of nature. Biologists must also keep themselves open-minded to the new technologies in other industrial communities. Making use of industrial engineering capabilities for the development of enhanced fishery resources is of great significance for marine ranching systems.

### Acknowledgment

This paper is based upon an intensive study being done by the research committee on the marine ranching system, which was organized in 1981, and which is still active now. This committee has been working together under a research contract with the Research Council on Agriculture, Forestry, and Fisheries, which consists of some thirty companies among the 120 member firms of the RIOE.

### Citations

DSI (Department of Statistics and Information)

1984. Fisheries statistics of Japan 1984, DSI. Ministry of Agriculture, Forestry, and Fisheries, Government of Japan. (In English.)

JFA (Japan Fisheries Association)

1987. Fisheries of Japan 1987. (In English.)

MAFF (Ministry of Agriculture, Forestry, and Fisheries)

1987. Annual Report on Japan's Fisheries, Fiscal 1986, Summary. (In English.)

Research Committee on marine ranching system (Research Institute for Ocean Economics)

1981. Model study on Environmental Monitoring system for marine ranching. (In Japanese.)

1982. Marine Ranching Program: enlargement method of favorable environmental conditions and monitoring system. (In Japanese.)

1983. Marine Ranching System: a model study. (In Japanese.)

1984. Marine Ranching System: a Preliminary assessment. (In Japanese)

1985. Study on enrichment method of the marine ranching ground. (In Japanese.)

1986. Study on ranching ground use development by cultivation technology (I), with 1) development of data based on marine ranching, 2) examination on the integration of biology and engineering technologies. (In Japanese.)

1987. Study on ranching ground use development by cultivation technology (II) with examination on the integration of biology and engineering technologies. (In Japanese.)

1988. Study on ranching ground use development by cultivation technology (III) with examination on the integration of biology and engineering technologies. (In Japanese.)



# Economic Problems of the Marine Ranching System

KATSUO TAYA

*National Research Institute of Fisheries Science  
5-5-1 Kachidoki, Chuo-ku  
Tokyo 104, Japan*

AKIRA HASEGAWA

*Tokyo University of Fisheries  
4-5-7 Konan, Minato-ku  
Tokyo 108, Japan*

YOSHIO MASUI

*Tokyo University of Agriculture  
1-1-1 Sakuragaoka, Setagaya-ku  
Tokyo 156, Japan*

## ABSTRACT

The major challenge facing the Marine Ranching Project is to increase fishery production in an economically efficient manner. To accomplish this, new technology such as improved seed production methods is required, along with an integrated approach that includes well planned development of local economies as well as total resource management and harvest regulation. This report analyzes the work of the Marine Ranching Project on the production and release of masu salmon (*Oncorhynchus masou*) by examining the relationship between production and release costs and the rate of smoltification. In addition, survey data show that most of the masu salmon taken in Hokkaido from October to March are juveniles under 600 g, and that the economic value of the fishery could be raised considerably if the target fish were allowed to reach an adult size of 1,500 g before harvesting. The report also notes that the masu salmon fishery plays an important role in the regional economies of northern Japan, and that seed release and harvest regulations must be designed to meet the economic and social needs of the various regions and communities that depend heavily on the resource.

## Introduction

The most important tasks now facing the masu salmon (*Oncorhynchus masou*) Marine Ranching Project are the economically efficient production and release of smolt seed. At present, many researchers are developing new seed production methods and studying the ecology and physiology of masu salmon.

This report analyzes three methods of masu salmon seed production and release: autumn release of 1+ year seed obtained from wild fish (hereafter referred to as autumn release); spring release of 1+ year seed obtained from wild fish (spring release); and spring release of 0+ year seed obtained from hatchery-raised fish (hatchery spring release). The economic merits, demerits, and other problems associated with each method are analyzed and discussed.

This report also analyzes the market price mechanism for masu salmon and evaluates the economic benefits of managing the fishery through restrictions on the harvest of undersized immature fish. Finally, the report reviews the role of the masu salmon fishery in the northern prefectures of Hokkaido, Aomori, Iwate, Akita, and Niigata and discusses ways of coordinating the Marine Ranching Project with local variables such as types of fishing gear, level of fishing effort, and fishery production costs. Data on monthly harvest rates and average fish body weights were collected from the Prefectural Fisheries Experimental Stations of these governments.

The research was divided into the following segments: 1) Comparative study of masu salmon seed production costs at the Prefectural Hatchery Stations at Iwate; 2) Economic comparison of autumn release,

**Table 1**  
Seed production cost of masu salmon per fish (in yen). (Iwate Prefecture Office 1974.)

	Autumn release	Spring release	Hatchery spring release
Eggs	2.0	2.0	2.0
Feed (1.5) <sup>a</sup>	4.69	9.38	7.5
(2.5) <sup>a</sup>	7.81	15.63	12.5
Power/fuel	0.75	2.0	1.2
Consumable items	0.75	1.5	1.2
Labor	5.28	6.36	4.2
Transportation	1.25	2.5	2.0
Maintenance	2.0	8.0	3.2
Survival ratio	0.5	0.4	0.6
Total cost per fish			
(1.5)	18.72	34.74	22.63
(2.5)	21.84	40.99	27.63

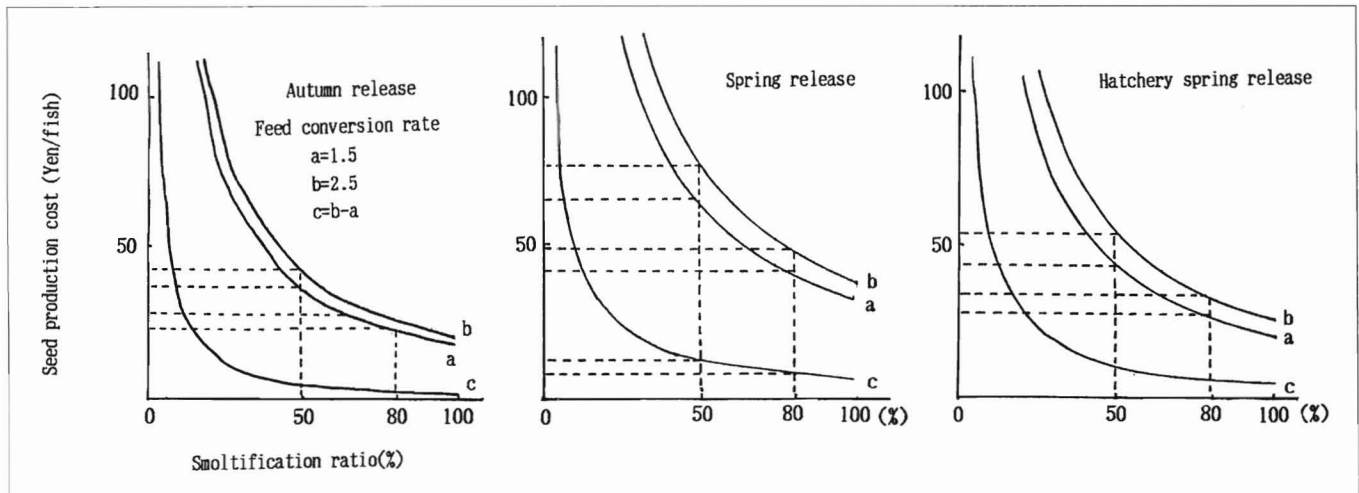
<sup>a</sup>Parentheses contain feed conversion ratios of 1.5 (minimum) and 2.5 (maximum).

$$\text{Conversion ratio} = (A-B)/C \times 100,$$

where A = Final weight (g/fish)

B = Start weight

C = Feed weight.

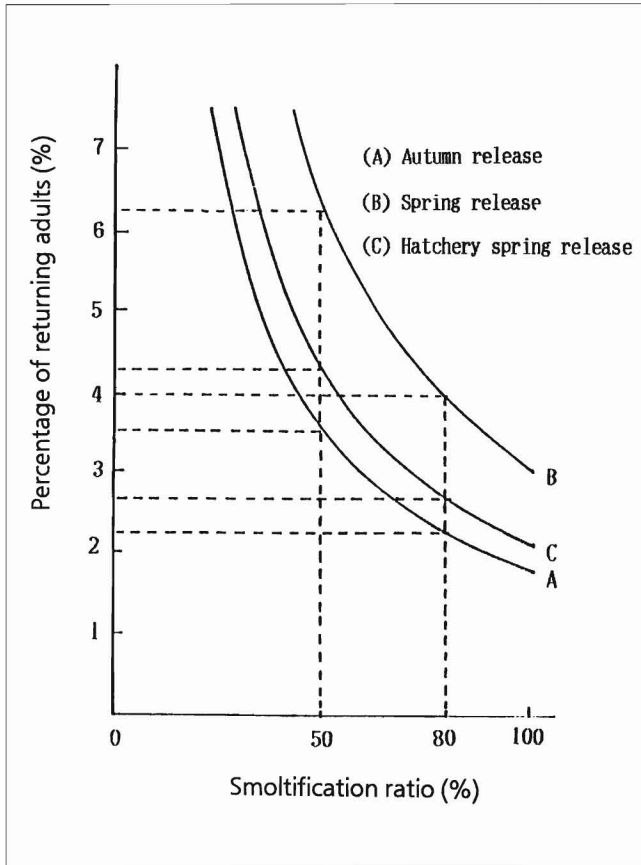


**Figure 1**

Ratio of seed production costs to the smoltification ratio in masu salmon. Solid lines (a and b) represent various feed conversion rates: a = 1.5; b = 2.5. Line c indicates the values for b-a.

spring release, and hatchery spring release methods for the production and release of masu salmon, focusing on smoltification and recapture ratios; 3) Collection of distribution and price data in various

regions with attention paid to fish size and the unit weight market price; and 4) Investigation of fishing gear, fishing effort and fishery production costs for masu salmon in various regions.



**Figure 2**

Percentage of returning adults needed in relation to the smoltification ratio. A=autumn release; B=spring release; and C=hatchery spring release.

## Analysis of Economic Efficiency

The approximate seed production costs expected using each of the three methods are shown in Table 1 (Iwate Prefecture Office 1974). Costs are lowest for the autumn release method and highest for the spring release method. The most important consideration, however, is the combined production and release costs per fish in relation to the smoltification ratio which is graphed for each method in Figure 1, where each curve indicates a different feed conversion rate. If the smoltification ratio ( $x$ ) is assumed to be constant between methods and varies between 50 and 80%, the costs per fish are as follows:

- between  $18.72/x$  and  $21.48/x$  yen for the autumn release method,
- between  $22.63/x$  and  $27.63/x$  for the hatchery spring release method, and
- between  $34.74/x$  and  $40.99/x$  yen for the spring release method.

In actual practice, however, the smoltification ratio tends to be around 50% for the autumn and spring release methods, and around 80% for the hatchery spring release method. When this is taken into consideration, the spring hatchery release method is shown to be the most economically efficient in terms of production and release costs.

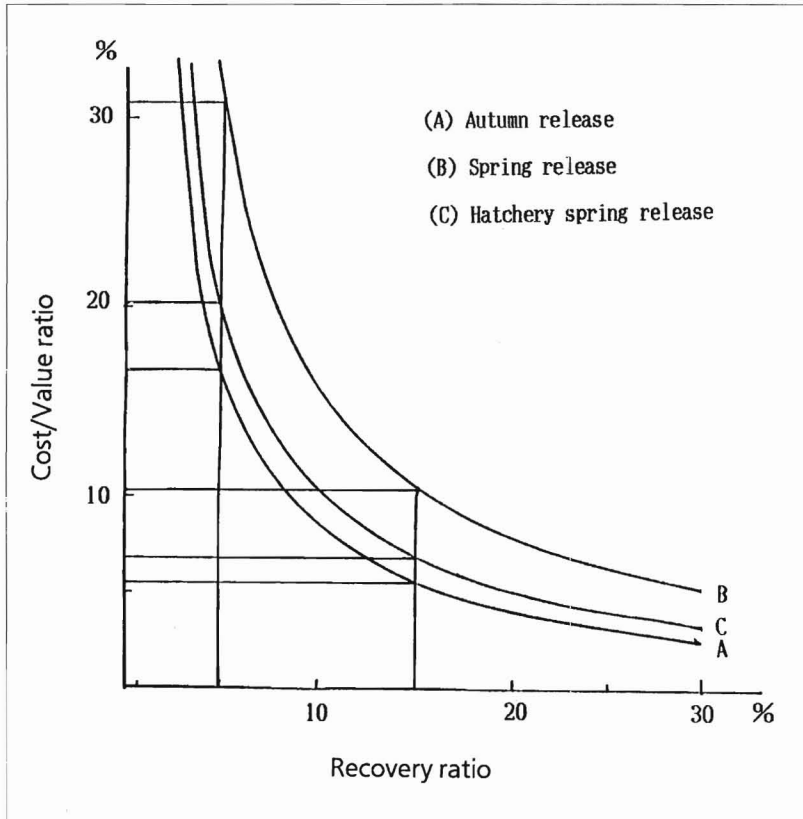
Production and release costs are only one part of the overall economic aspects of the Marine Ranching

**Table 2**  
Fry production cost and value of returning fish for chum salmon.

Year group	Investment salmon ranching (million yen)	Production cost (yen) of salmon fry/fish	Cost of returning salmon (yen)		Market price (yen/kg) of returning salmon	Production cost of returning salmon per kg/market price $\times 100(\%)$
			per fish	per kg		
1962-65	374-540	0.99-1.60	86.7-241.9	24.8-69.1	360-545	5.8-13.1
Average	465	1.35	16.51	47.2	464	9.95
1966-70	476-767	1.34-2.90	70.5-126.0	20.1-36.0	439-725	3.0-6.2
Average	619	1.91	85.7	24.5	586	4.29
1971-75	992-2489	1.72-3.10	76.8-139.6	21.9-36.3	609-1029	2.5-5.76
Average	1455	2.58	111.6	31.9	891	3.72
1976-79	2423-5806	4.02-6.65		3.5 kg/fish		
Average	3698	5.04				

**Table 3**  
Seed production cost and value of returning fish for masu salmon. (Iwate Prefecture Office 1974.)

Type	Production cost (yen) per fish	Return ratio	Cost (yen) of returning masu salmon per fish	Cost (yen) of returning masu salmon per kg	Market price of returning fish (yen/kg)	Cost of return masu salmon/Unit price × 100 (%)
Autumn release	18.72	$x$	$18.72/x$	$12.48/x$	1500	$0.83/x$
Spring release	34.72	$x$	$34.74/x$	$23.16/x$	1500	$1.54/x$
Spring hatchery release	22.63	$x$	$22.63/x$	$15.09/x$	1500	$1.01/x$



**Figure 3**  
Relationship of the recovery ratio to the cost/value ratio for masu salmon (Iwate Prefecture Office 1974.)

System. Recapture ratios also play a vital role. If the market price of recaptured fish is assumed to be 2,250 yen/fish, fishery production costs are assumed to be negligible, the marketing commission rate is assumed to be 5%, and the conversion ratio assumed to be 2.0, then the upper and lower ranges of the recovery ratio ( $y$ ) for each method (as it varies with the smoltification ratio  $x$ ) can be calculated as follows:

- autumn release method  $y = 257.5/x$  and  $y = 94.9/x$ ,
- spring release method  $y = 480.8/x$  and  $y = 177.1/x$ ,  
and
- hatchery spring release method  $y = 319.2/x$  and  $y = 117.6/x$ .

Figure 2 plots smoltification ratio versus recovery ratio for each method. From the data in Figure 1 it appears that the hatchery spring release method, with an 80% smoltification ratio as compared to only 50% for the other two methods, is most efficient. In reality, however, the recovery ratio for this method tends to be lower than for the other two, and thus research is required to improve the recovery ratio for spring hatchery release fish.

One way of evaluating the economic efficiency of the Marine Ranching Project is to compare production and release costs with the value of the recovered fish. Production and release costs as a percentage of the unit weight value of recovered fish for chum salmon (*O. keta*) are shown in Table 2. Because production costs are a small fraction of the value of a

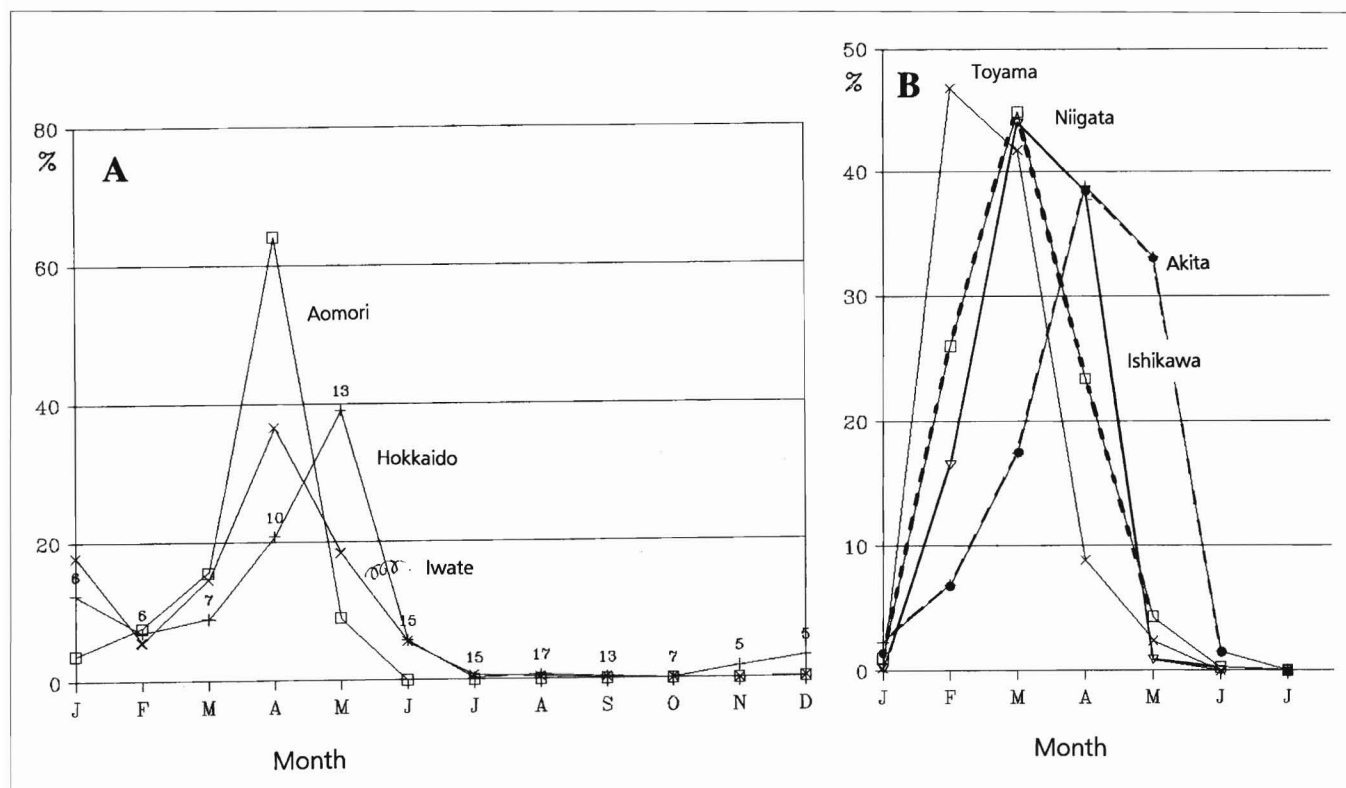


Figure 4

Monthly harvest patterns for masu salmon in 1986. (A) shows average body weight of salmon harvested in Hokkaido and Honshu prefectures ( $\times 100$  g).  $\square$  = Aomori;  $+$  = Hokkaido;  $\times$  = Iwate. (B) shows average body weight of salmon harvested in Honshu prefectures;  $\square$  = Niigata;  $\bullet$  = Akita;  $\times$  = Toyama;  $\nabla$  = Ishikawa.

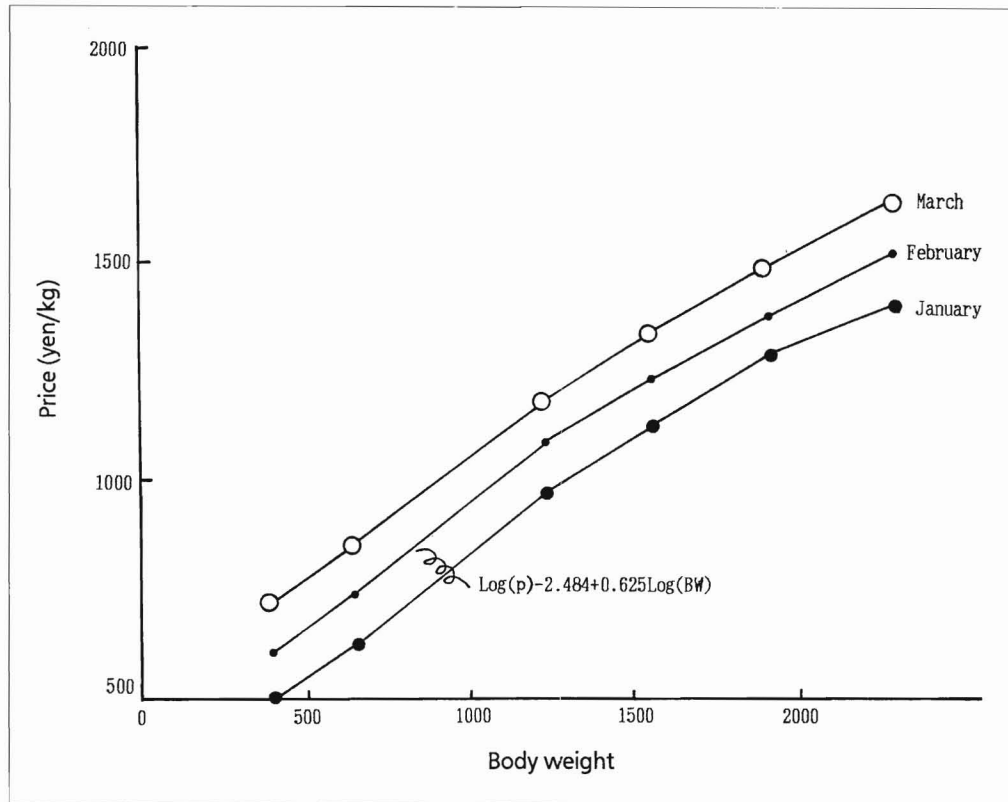
returning salmon, a recovery ratio of even 2% produces an increase in the economic value of the fishery. The same calculations are shown in Table 3 for masu salmon for each release method; these results are graphed in Figure 3. If the target figure of a 15% recovery ratio were achieved for all methods, then the cost/value ratio (cost per returning salmon, value is market price per fish) would vary between 5 and 10%, which is a desirable result. Even if the ratio is calculated at the present recovery rate of 5%, the cost/value ratios would vary from 15–30%, indicating that artificial seed production projects have the potential for contributing to the masu salmon fishery.

Seasonal harvest patterns of masu salmon for selected prefectures in 1986 are shown in Figure 4. In Hokkaido, most of the fish harvested between October and March are juveniles weighing under 600 g. The current market value of such undersized masu salmon is only 500 yen/kg (Fig. 5). The market value of adult fish over 1,500 g, however, rises to 1,500 yen/kg. Thus, if these undersized juveniles are allowed to mature before harvesting, the value per fish will rise from 250 yen (500 g at 500 yen/kg) to 2,250 yen (1,500 g at 1,500 yen/kg). These figures represent a nine-fold increase in value. Obviously, an increase in

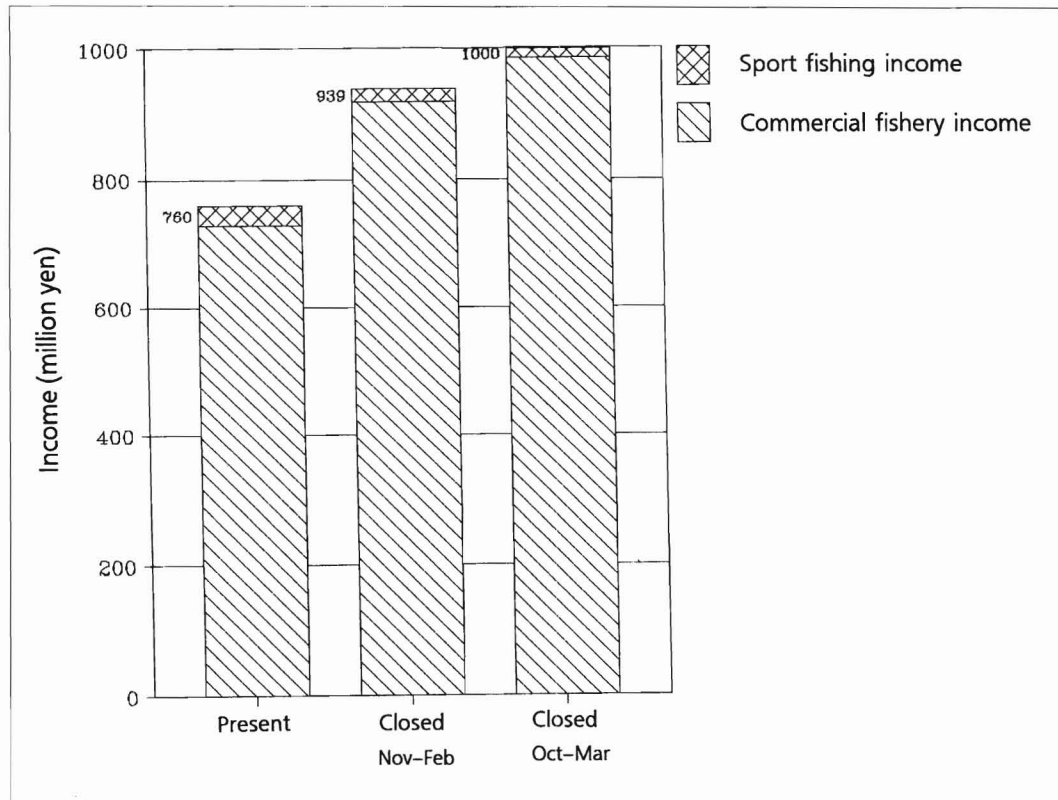
economic value of the fishery can be obtained if the juveniles harvested in Hokkaido are allowed to mature before being harvested elsewhere. Calculations show that if the fishery were closed from November to February, an increase of 23% (from 7.6 billion yen to 9.4 billion yen) could be obtained (Fig. 6). If the closure were extended to include the entire period from October to March, the increase would rise to 31% (from 7.6 billion yen to 10.0 billion yen). A problem arises in that fishermen in Hokkaido and elsewhere depend heavily on income from sport fishing during this period and would certainly oppose any move to close or restrict the fishery. Thus, an integrated plan is required that maximizes the overall economic value of the fishery while protecting the interests of local harvest groups.

### Role of Masu Salmon in Local and Regional Economies

Our investigations showed that although there is a noticeable lack of stability in catch volume, masu salmon play an important role in both the local and regional economies of Hokkaido, Aomori, Iwate, and



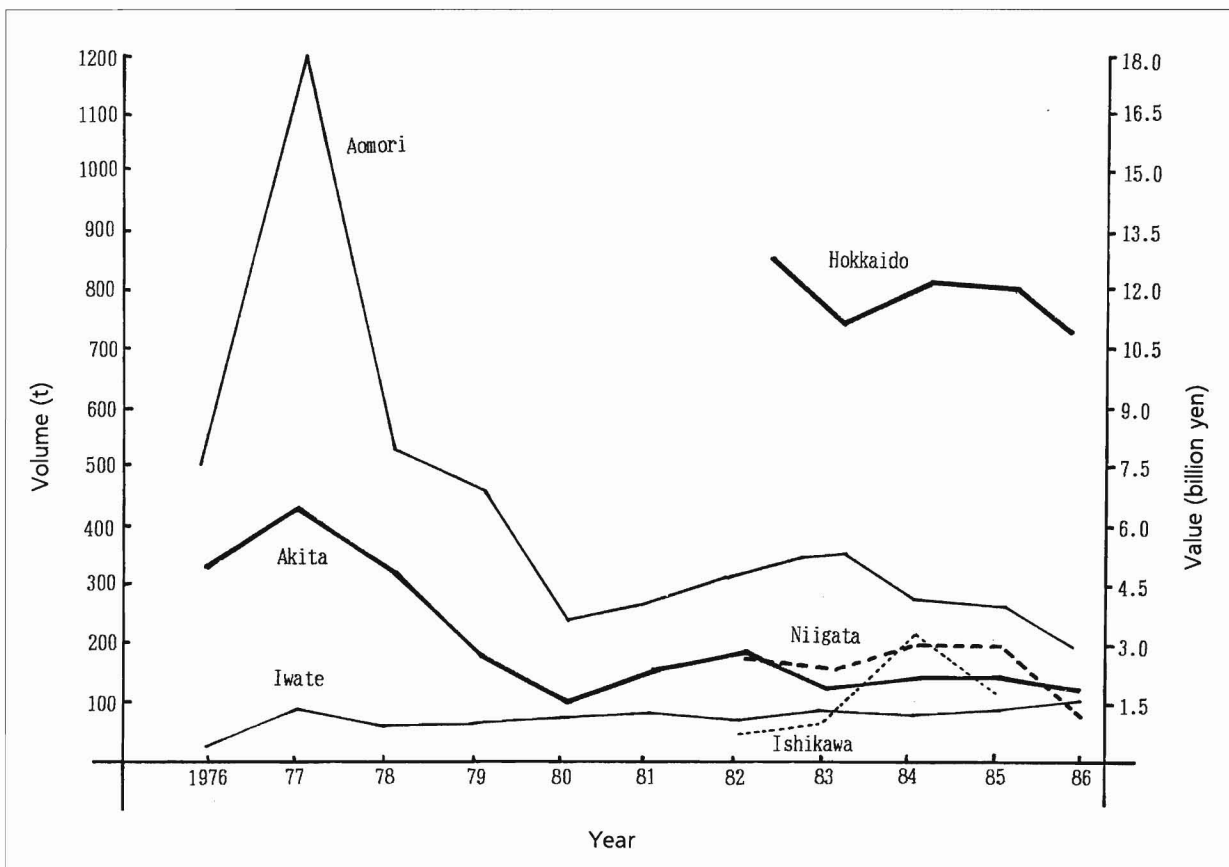
**Figure 5**  
Relationship between price and weight of masu salmon (Kamuena Fisheries Cooperative 1987).



**Figure 6**  
Evaluation of benefits of fishery restrictions in (Hokkaido Salmon Hatchery 1988).

**Table 4**  
Estimated landings of masu salmon in Japan (1984) (in metric tons).

	Japan Sea		Pacific Ocean		Nemuro Straits	Okhotsk Sea	Total	
	Hokkaido	Honshu	Hokkaido	Honshu			Hokkaido	Honshu
Off shore fishing	187.6	744.1	418.3	—	—	—	605.9	744.1
Coastal fishery	562.4	1162.4	224.0	143.4	2.1	43.5	832.0	1305.8
Total landings	750.0	1906.5	642.5	143.4	2.1	43.5	1437.9	2049.9
Each area	2656.5		785.7		2.1	43.5	3487.9	
Percentage (%)	76.17		22.53		0.06	1.25	100.0	



**Figure 7**

Masu salmon landings of the coastal fisheries by weight (metric tons) and value (value assumed at 1,500 yen/kg).

Niigata prefectures. The total annual catch fluctuates between 3,500 and 4,000 metric tons (t), the average price varies from 1,000 to 1,500 yen/kg, and the total value of the fishery ranges from 35 to 60 billion yen/year. The geographical distribution of the catch for 1984 is shown in Table 4.

Hokkaido accounted for 41% (1,438 t) and Honshu for 59% (2,050 t) of the total harvest. Seventy-six percent (2,656 t) of the catch was harvested in the Japan Sea, 22% (785 t) in the Pacific Ocean, 1.2% (43 t) in the Sea of Okhotsk, and 0.06% (2 t) in the Nemuro Straits region. Clearly, the Japan Sea

**Table 5**

Family fishery income 1985 (1,000 yen). t = metric tons. Ministry of Agriculture, Forestry, and Fisheries, government of Japan (1985).

Family fishery	fishing gross income	fishing expenses	fishing net income	net income rate (%)
<b>Japan Sea area</b>				
1 t (under)	1,557	667	890	57.1
1-3 t	3,017	1,641	1,376	45.6
3-5 t	7,208	4,636	2,572	35.6
5-10 t	14,859	11,786	3,073	20.6
Bag net	6,668	4,410	2,258	33.8
Average	4,212	2,680	1,532	36.3
<b>Pacific Ocean area</b>				
1 t (under)	1,859	773	1,076	57.8
1-3 t	3,581	1,301	2,280	63.6
3-5 t	7,470	4,415	3,055	40.8
5-10 t	10,926	7,219	3,707	33.9
Bag net	5,544	2,611	2,933	52.9
Average	4,220	2,241	1,979	46.8

fishery is by far the most important, accounting for 40 billion yen in total value as compared to 8-12 billion yen for the Pacific Ocean fishery.

At the national level, coastal fisheries harvested 39% (1,349 t) and offshore fisheries 61% (2,137 t) of the total catch. The figures for the Pacific Ocean fishery, were 53% (418 t) for coastal and 47% (367 t) for offshore areas; while in the Japan Sea the major percentages were reversed, with coastal yields 35% (931 t) and offshore harvests at 65% (1,724 t). Catch statistics by region and fishery are shown in Table 4, and Figure 7 graphs the volume and value of landings by prefecture for the 10-year period from 1976 to 1986.

Fishing methods for masu salmon were found to vary widely, and include gillnet, bottom trawl, longline, pole and line, and setnet techniques. In the Japan Sea region of Hokkaido (e.g., Shakotan Peninsula area) sportfishing was found to be an important source of income for about 45 vessels. This sportfishing industry harvests a large percentage of undersized juveniles, and as such adversely affects the efficiency of the masu salmon Marine Ranching Project.

Although landings in prefectures such as Yamagata, Ishikawa, and Toyama are relatively small,

masu salmon is none the less a valuable local resource and an important ingredient in many traditional seafood dishes. Family income by vessel size is shown in Table 5 for fishing families in the northern Japan Sea and northern Pacific Ocean regions (MAFF 1985). Net family income from fisheries varies from 0.890 to 3.073 million yen in the Japan Sea, and from 1.076 to 3.707 million yen in the Pacific Ocean. Because the market price of masu salmon is relatively high, this fish represents an important source of income for these fishing families. Thus, investment in masu salmon marine ranching facilities will be a crucial element in developing the local and regional economies in these areas.

## Citations

- Hokkaido Salmon Hatchery.  
1988. Annual report of the Hokkaido salmon hatchery. (In Japanese.)
- Iwate Prefecture Office.  
1974. Exploitation program of masu salmon, p. 24-25. (In Japanese.)
- Ministry of Agriculture, Forestry, and Fisheries.  
1985. Annual report on fisheries economics (family fishery). (In Japanese.)