

Environmental Quality and Aquaculture Systems

*Proceedings of the Thirteenth
U.S.-Japan Meeting on Aquaculture,
Mie, Japan,
October 24-25, 1984*

Carl J. Sindermann (editor)

NOAA TECHNICAL REPORT NMFS

The major responsibilities of the National Marine Fisheries Service (NMFS) are to monitor and assess the abundance and geographic distribution of fishery resources, to understand and predict fluctuations in the quantity and distribution of these resources, and to establish levels for their optimum use. NMFS is also charged with the development and implementation of policies for managing national fishing grounds, development and enforcement of domestic fisheries regulations, surveillance of foreign fishing off United States coastal waters, and the development and enforcement of international fishery agreements and policies. NMFS also assists the fishing industry through marketing service and economic analysis programs, and mortgage insurance and vessel construction subsidies. It collects, analyzes, and publishes statistics on various phases of the industry.

The NOAA Technical Report NMFS series was established in 1983 to replace two subcategories of the Technical Reports series: "Special Scientific Report—Fisheries" and "Circular." The series contains the following types of reports: Scientific investigations that document long-term continuing programs of NMFS; intensive scientific reports on studies of restricted scope; papers on applied fishery problems; technical reports of general interest intended to aid conservation and management; reports that review in considerable detail and at a high technical level certain broad areas of research; and technical papers originating in economics studies and from management investigations. Since this is a formal series, all submitted papers receive peer review and those accepted receive professional editing before publication.

Copies of NOAA Technical Reports NMFS are available free in limited numbers to governmental agencies, both Federal and State. They are also available in exchange for other scientific and technical publications in the marine sciences. Individual copies may be obtained from: U.S. Department of Commerce, National Technical Information Service, 5285 Port Royal Road, Springfield, VA 22161. Although the contents have not been copyrighted and may be reprinted entirely, reference to source is appreciated.

34. Additions to a revision of the shark genus *Carcharhinus*: Synonymy of *Aprionodon* and *Hypoprion*, and description of a new species of *Carcharhinus* (Carcharhinidae), by J. A. F. Garrick. November 1985, 26 p.
35. Synoptic review of the literature on the Southern oyster drill *Thais haemastoma floridana*, by Philip A. Butler. November 1985, 9 p.
36. An egg production method for estimating spawning biomass of pelagic fish: Application to the northern anchovy, *Engraulis mordax*, by Reuben Lasker (editor). December 1985, 99 p.
37. A histopathologic evaluation of gross lesions excised from commercially important North Atlantic marine fishes, by Robert A. Murchelano, Linda Despres-Patanjo, and John Ziskowski. March 1986, 14 p.
38. Fishery atlas of the northwestern Hawaiian Islands, by Richard N. Uchida and James H. Uchiyama (editors). September 1986, 142 p.
39. Survey of fish protective facilities at water withdrawal sites on the Snake and Columbia Rivers, by George A. Swan, Tommy G. Withrow, and Donn L. Park. April 1986, 34 p.
40. Potential impact of ocean thermal energy conversion (OTEC) on fisheries, by Edward P. Myers, Donald E. Hoss, Walter M. Matsumoto, David S. Peters, Michael P. Seki, Richard N. Uchida, John D. Ditmars, and Robert A. Paddock. June 1986, 33 p.
41. A stationary visual census technique for quantitatively assessing community structure of coral reef fishes, by James A. Bohnsack and Scott P. Bannerot. July 1986, 15 p.
42. Effects of temperature on the biology of the northern shrimp, *Pandalus borealis*, in the Gulf of Maine, by Spencer Apollonio, David K. Stevenson, and Earl E. Dunton, Jr. September 1986, 22 p.
43. Environment and resources of seamounts in the North Pacific, by Richard N. Uchida, Sigeiti Hayasi, and George W. Boehlert (editors). September 1986, 105 p.
44. Synopsis of biological data on the porgies, *Calamus arctifrons* and *C. proridens* (Pisces: Sparidae), by George H. Darcy. September 1986, 19 p.
45. Meristic variation in *Sebastes* (Scorpaenidae), with an analysis of character association and bilateral pattern and their significance in species separation, by Lo-chai Chen. September 1986, 17 p.
46. Distribution and relative abundance of pelagic nonsalmonid nekton off Oregon and Washington 1979-84, by Richard D. Brodeur and William G. Pearcy. December 1986, 85 p.
47. Reproduction, maturation, and seed production of cultured species: Proceedings of the twelfth U.S.-Japan meeting on aquaculture, Baton Rouge, Louisiana, October 25-29, 1983, by Carl J. Sindermann (editor). February 1987, 73 p.
48. Widow rockfish: Proceedings of a workshop, Tiburon, California, December 11-12, 1980, by William H. Lenarz and Donald R. Gunderson (editors). January 1987, 57 p.
49. Reproduction, movements, and population dynamics of the southern kingfish, *Menticirrhus americanus*, in the northwestern Gulf of Mexico, by Stephen M. Harding and Mark E. Chittenden, Jr. March 1987, 21 p.
50. Preparation of acetate peels of valves from the ocean quahog, *Arctica islandica*, for age determinations, by John W. Ropes. March 1987, 5 p.
51. Status, biology, and ecology of fur seals: Proceedings of an international workshop, Cambridge, England, 23-27 April 1984, by John P. Croxall and Roger L. Gentry (editors). June 1987, 212 p.
52. Limited access alternatives for the Pacific groundfish fishery, by Daniel D. Huppert (editor). May 1987, 45 p.
53. Ecology of east Florida sea turtles: Proceedings of the Cape Canaveral, Florida, sea turtle workshop, Miami, Florida, February 26-27, 1985, by Wayne N. Witzell (convener and editor). May 1987, 80 p.
54. Proximate and fatty acid composition of 40 southeastern U.S. finfish species, by Janet A. Gooch, Malcolm B. Hale, Thomas Brown, Jr., James C. Bonnet, Cheryl G. Brand, and Lloyd W. Reiger. June 1987, 23 p.
55. Proximate composition, energy, fatty acid, sodium, and cholesterol content of finfish, shellfish, and their products, by Judith Krzynowek and Jenny Murphy. July 1987, 53 p.
56. Some aspects of the ecology of the leatherback turtle *Dermochelys coriacea* at Laguna Jolova, Costa Rica, by Harold F. Hirth and Larry H. Ogren. July 1987, 14 p.
57. Food habits and dietary variability of pelagic nekton off Oregon and Washington, 1979-1984, by Richard D. Brodeur, Harriet V. Lorz, and William G. Pearcy. July 1987, 32 p.
58. Stock assessment of the Gulf menhaden, *Brevoortia patronus*, fishery, by Douglas S. Vaughan. September 1987, 18 p.
59. Atlantic menhaden, *Brevoortia tyrannus*, purse seine fishery, 1972-84, with a brief discussion of age and size composition of the landings, by Joseph W. Smith, William R. Nicholson, Douglas S. Vaughan, Donnie L. Dudley, and Ethel A. Hall. September 1987, 23 p.
60. Gulf menhaden, *Brevoortia patronus*, purse seine fishery, 1974-85, with a brief discussion of age and size composition of the landings, by Joseph W. Smith, Eldon J. Levi, Douglas S. Vaughan, and Ethen A. Hall. December 1987, 8 p.
61. Manual for starch gel electrophoresis: A method for the detection of genetic variation, by Paul B. Aebersold, Gary A. Winans, David J. Teel, George B. Milner, and Fred M. Utter. December 1987, 19 p.
62. Fishery publication index, 1980-85; Technical memorandum index, 1972-85, by Cynthia S. Martin, Shelley E. Arenas, Jacki A. Guffey, and Joni M. Packard. December 1987, 149 p.
63. Stock assessment of the Atlantic menhaden, *Brevoortia tyrannus*, fishery, by Douglas S. Vaughan and Joseph W. Smith. January 1988, 18 p.
64. Illustrated key to penaeoid shrimps of commerce in the Americas, by Isabel Pérez Farfante. April 1988, 32 p.
65. History of whaling in and near North Carolina, by Randall R. Reeves and Edward Mitchell. March 1988, 28 p.
66. Atlas and zoogeography of common fishes in the Bering Sea and northeastern Pacific, by M. James Allen and Gary B. Smith. April 1988, 151 p.

NOAA Technical Report NMFS 69

Environmental Quality and Aquaculture Systems

*Proceedings of the Thirteenth
U.S.-Japan Meeting on Aquaculture,
Mie, Japan,
October 24-25, 1984*

Carl J. Sindermann (editor)

Panel Chairmen:
Conrad Mahnken, United States
Kaoru Tatara, Japan

*Under the U.S.-Japan Cooperative Program
in Natural Resources (UJNR)*

October 1988

U.S. DEPARTMENT OF COMMERCE

C. William Verity, Jr., Secretary

National Oceanic and Atmospheric Administration

William E. Evans, Under Secretary for Oceans and Atmosphere

National Marine Fisheries Service

James Brennan, Assistant Administrator for Fisheries

PREFACE

The United States and Japanese counterpart panels on aquaculture were formed in 1969 under the United States-Japan Cooperative Program in Natural Resources (UJNR). The panels currently include specialists drawn from the federal departments most concerned with aquaculture. Charged with exploring and developing bilateral cooperation, the panels have focused their efforts on exchanging information related to aquaculture which could be of benefit to both countries.

The UJNR was begun during the Third Cabinet-Level Meeting of the Joint United States-Japan Committee on Trade and Economic Affairs in January 1964. In addition to aquaculture, current subjects in the program include desalination of seawater, toxic microorganisms, air pollution, energy, forage crops, national park management, mycoplasmosis, wind and seismic effects, protein resources, forestry, and several joint panels and committees in marine resources research, development, and utilization.

Accomplishments include: increased communication and cooperation among technical specialists; exchanges of information, data, and research findings; annual meetings of the panels, a policy-coordinative body; administrative staff meetings; exchanges of equipment, materials, and samples; several major technical conferences; and beneficial effects on international relations.

Conrad Mahnken - United States
Kaoru Tatara - Japan

The National Marine Fisheries Service (NMFS) does not approve, recommend or endorse any proprietary product or proprietary material mentioned in this publication. No reference shall be made to NMFS, or to this publication furnished by NMFS, in any advertising or sales promotion which would indicate or imply that NMFS approves, recommends or endorses any proprietary product or proprietary material mentioned herein, or which has as its purpose an intent to cause directly or indirectly the advertised product to be used or purchased because of this NMFS publication.

Contents

Chiba, Kenji

Relationship between fish culture methods and pondwater quality in freshwater fish culture 1

Fukusho, Kunihiko, and Chikara Kitajima

Environmental management of larval rearing of marine fishes—A short history of research to prevent lordosis in red sea bream, *Pagrus major* 9

Funakoshi, Shoji, Tohru Suzuki, and Koji Wada

Salinity tolerances of marine bivalves 15

Furukawa, Astushi, Hiroshi Fukatani, and Shuji Tsuchida

Temperature preference of immature horse mackerel, *Trachurus japonicus*, in a vertical temperature gradient 19

Nakanishi, Takashi

Effects of environment on seedlings of king crab, *Paralithodes camtschaticus* 25

Noma, Toshifumi

Some methods of water-flow control for mariculture 37

Ohwada, Kouichi, and Haruhiko Uemoto

Environmental conditions in pearl oyster culture grounds in Japan 45

Relationship between fish culture methods and pondwater quality in freshwater fish culture

KENJI CHIBA

*Fisheries Laboratory Faculty of Agriculture
University of Tokyo Bentenjima, Hamana
Shizuoka, 431-02 Japan*

Freshwater fish, such as common carp, eel, rainbow trout and ayu, are cultured using various methods. Based on the manner of oxygen supply and waste substance removal, these methods can be divided into three groups: stagnant-water culture, running-water culture, and recirculation-system culture.

The stocking density in ponds is variable depending upon the culture method. Each culture method has its own oxygen-supply capacity, and this capacity limits the total amount of fish to be stocked in each unit. Generally, the running-water culture method allows an extremely high stocking density, whereas stocking density is lowest in the stagnant-water culture method. On the other hand, the necessary water volume for each kilogram of fish weight-gain is extremely high in running-water culture, and is lowest in the recirculation-system culture. In other words, the efficiency of water utilization is best in the recirculation-system culture and lowest in the running-water culture.

As each fish-culture method has its own means of oxygen supply and waste removal, the pattern of water-quality fluctuation is quite simple to understand in running-water ponds but is complicated in stagnant-water ponds. Eel culture in greenhouse ponds is a method recently developed in Japan. Although it had originally been developed from stagnant-water culture methods, the techniques employed for oxygen supply and waste removal in this method are different from those of the stagnant-water culture method. Atmospheric oxygen is dissolved mechanically by water wheels, and waste substances are removed by discharging water frequently. Water-quality fluctuations in greenhouse ponds follow a less complicated dynamic sequence than in stagnant-water ponds. In this method, in which eels are stocked at high density, extraordinarily high concentrations of $\text{NH}_4\text{-N}$, $\text{NO}_2\text{-N}$, $\text{PO}_4\text{-P}$ and organic substances are always observed in pondwater. Under such water-quality conditions, eels still grow very rapidly.

Generally, in each culture method about 20% of the nitrogen supplied with feeds is converted to fish body substance, and the rest is transferred to soluble and particulate substances released into the pondwater and sediments. When fish are stocked at a high density, a large amount of feed is offered daily. Accordingly, those substances accumulate to a high level in the ponds. Especially in ponds without water exchange or with a small inflow rate, these substances will accumulate continuously to remarkable levels. Eel culture in greenhouse ponds is a typical example of such situations. The fact that under such water-quality conditions eels still can be produced on a commercial scale gives several hints about water-quality management strategies in fish-culture ponds, but these are still insufficient for proper adjustment of operational strategies.

An urgent need exists, therefore, to clarify the growth-limiting factors under sufficient dissolved-oxygen conditions. Further, it is also necessary to improve techniques for treating discharged pondwaters and sediments which are highly loaded with inorganic and organic substances, in order to prevent the pollution of rivers, lakes, and the sea, to which aquaculture units release their wastewater.

It seems reasonable to determine the relationship between the fish-culture methods employed and the pondwater quality achieved, for identification of problems concerned with the effective utilization of water resources in fish production. In this paper, water-quality fluctuations observed under various culture methods and the resulting growth-limiting factors are examined.

Fish-culture method and stocking density

The stocking densities per meter² and meter³ employed under various culture methods are shown in Table 1, along with water volumes required to produce 1 kg of fish under various methods. The culture of carp is used here as an example to demonstrate operational conditions (Nakamura 1963, Chiba 1965a). The ratio between harvesting and stocking differs little among the methods described, and it is assumed that growth rates necessary for carp to reach market size were not dependent on culture methods. At harvest, the fish weight per meter² ranged between 0.1 and 0.5 kg in the irrigation pond, between 60 and 190 kg in the running-water pond, between 7 and 68 kg in the floating cage, and between 11 and 33 kg in the recirculation system. The harvest in the running-water pond was about 100 to 400 times greater than in the irrigation pond. On the other hand, the water volume needed to produce 1 kg of carp was estimated at 4-20 m³ in the irrigation pond, 2.5-5.0 m³ in the artificial fish pond, and 1,000-2,000 m³ in the running-water pond. Thus, harvests from a surface area of 1 m² in running-water ponds were extremely high, but the water volume required to produce 1 kg of carp was much higher than in stagnant-water ponds. In the recirculation system, the stocking density was second highest, close to that in running-water ponds, but the water volume needed to harvest 1 kg carp was estimated at only 0.5-1.3 m³. These figures are remarkably small in comparison with those for running-water ponds.

The same relationships between these culture methods were also observed in ayu and eel culture. In the case of ayu, the harvest from a 1-m² pond area and the water volume required to produce 1 kg weight were 10-20 kg and 31.4-145.6 m³, respectively, in ordinary running-water ponds, whereas the necessary water volume was only 2.68-6.93 m³ in the recirculation system (Tokushima Pref. 1978). In the case of eel culture in stagnant-water ponds or with a small water supply, the stocking density was 0.6-4.5 kg/m² and the necessary water volume to produce 1 kg of weight was 24-193 m³. In the recirculation system, the values were 28 kg/m² and 1.2-1.5 m³, respectively (Mie Pref. 1978). In some specific cases, the stocking density in a recirculation system was as high as 50.6 kg/m² (Tanaka 1976).

The main differences between culturing methods lie in the principle of oxygen supply and the removal of waste from the ponds. In running-water ponds, oxygen is supplied with the inflowing water which also dilutes the waste substances produced by fish metabolism and carries them out with outflowing water. In the stagnant-water ponds, oxygen is usually supplied through photosynthesis by the phytoplankton populations, utilizing the nutrients supplied through waste products of fish which have been decomposed by bacteria. In the recirculation system, oxygen is mechanically supplied by waterwheels or blowers and airstones. The waste products are decomposed and oxidized by bacteria in the filter bed. It was thus concluded that the differences are caused by the differences in oxygen supply and waste removal systems.

Fish-culture method and water quality

The cycle of organic and inorganic substances which occur in fish ponds is shown schematically in Figure 1. Food is supplied daily to fish in the ponds. In other words, organic substances are added to the pond water everyday. Almost all food is taken by fish but

Table 1
Fish density using various carp culture methods.

Culture method	Fish pond	Harvest		Water volume required for 1 kg production (m ³)
		(kg/m ²)	(kg/m ³)	
Culture in stagnant water	Irrigation pond*	0.01-0.15	0.005-0.08	12-200
	Irrigation pond (with feeding)	0.1-0.5	0.05-0.25	4-20
	Culture pond	0.4-0.8	0.2-0.4	2.5-5.0
Culture in recirculation system	Recirculation-system pond	11-33	4-15	0.5-1.3
Culture in running water	Floating cage	7-60	3.5-34	—
	Running-water pond	60-190	30-95	1,000-2,000

*no feeding, only fertilizing the pond.

some is scattered into the water and deposited afterwards on the bottom. After digestion, feces are discharged which also settle on the bottom. At the same time, NH₄⁺ and urine are excreted through gills and kidney. Food and feces in the organic bottom sediments are decomposed by bacteria to inorganic substances. In the pondwater, phytoplankton starts to propagate utilizing these inorganic substances as nutrients. Oxygen is produced and CO₂ is utilized by phytoplankton in the process of photosynthesis. In contrast, dissolved oxygen is utilized and CO₂ is excreted by fish. Also, oxygen is consumed by bacteria and other organisms in pondwater and bottom mud.

These substances in the pondwater are diluted by inflowing water and carried away through the outlet. Total amounts of organic substances decomposed in fish ponds differ, depending upon the capacity of bacteria to decompose organic matter and the amount of total organic substances in ponds. The decomposition of organic matter by bacteria is not always at constant speed; the differences are dependent on the activity of the bacteria and the composition of the organic matter. The utilization rates of inorganic substances by phytoplankton, and the rates of oxygen consumption and excretion by fish also differ with their activity patterns, which also depend on the day and night cycle as well as other associated variations of environmental factors such as temperature. Accordingly, the supply and consumption of inorganic substances in the pond differ also with the size of phytoplankton and fish populations.

When the ponds are arranged in sequence along a small stream, it is observed that dissolved oxygen and pH values decrease whereas NH₄-N, NO₂-N, PO₄-P, alkalinity, and chemical oxygen demand increase in downstream ponds, receiving the water coming from upstream ponds (Chiba 1965b, Shirahata 1964).

In recirculation system ponds, where the activity of bacteria in the biofilter is sufficient to cope with the load, it is observed that NH₄-N increases markedly at the beginning of the culture period and then decreases sharply. In contrast to the decreasing NH₄-N concentration, NO₂-N level increases remarkably as a result of nitrification. Later on, the NO₂-N level decreases but at a slower rate. Thereafter, NH₄-N and NO₂-N are stabilized and maintained at nearly constant levels. However, NO₃-N increases gradually, and simultaneously pH values and alkalinity decreases. At the same time, total organic carbon and chemical oxygen demand also increase gradually (Kawai et al. 1964).

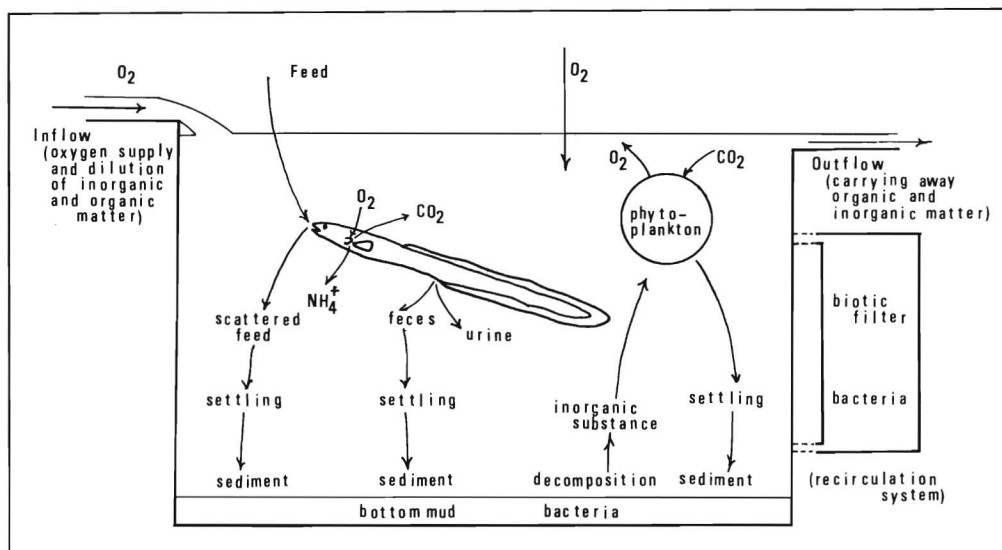

Figure 1
Cycling of organic and inorganic substances in fish-culture pond.

In the stagnant-water ponds, a very low water flowrate is seldom applied. Therefore, dissolved and particulate matter are not diluted continuously. Changes in water quality are mainly caused by the activities of phytoplankton, bacteria, and fish metabolism. Water quality changes are expressed in complicated patterns over long periods, reflecting the dynamics of all the influencing factors (Hirano 1976).

In addition to the long-term water quality changes, different patterns of diurnal water-quality fluctuations are observed in all three culture methods. In running-water ponds, clear diurnal changes in water quality are usually observed. With the commencement of feeding, dissolved oxygen and pH values decrease while $\text{NH}_4\text{-N}$ and chemical oxygen demand increase. After completion of feeding the concentrations of these parameters gradually return to their original values (Shizuoka Prefect. 1978). In recirculation ponds, the pattern of diurnal fluctuation in water quality is similar to that of running-water ponds (Tanaka 1976). In stagnant-water ponds, clear diurnal fluctuations in water quality are also observed. During daytime, the dissolved oxygen level increases through photosynthetic activity of phytoplankton and reaches its highest level in the afternoon. At night the dissolved oxygen level decreases because of respiration of organisms. If the phytoplankton dies or if the dominant species population is reduced and overturns to other species, the water quality of the pondwater changes suddenly. Usually, dissolved oxygen decreases while $\text{NH}_4\text{-N}$, $\text{NO}_2\text{-N}$, and $\text{PO}_4\text{-P}$ increase remarkably. In these cases fish lose their appetite or begin surfacing and sometimes die due to oxygen depletion. Thus, the patterns of water-quality fluctuations in fish ponds over a 24-hour period and over a long-term period are varied, depending on the culture method. The manner of oxygen supply to pondwater and waste removal from it may result in different patterns of water-quality fluctuations.

A new method for eel culture

Recently, a new method for eel culture was developed by eel culturists in Japan. In this method eels are cultured in heated water ponds in greenhouses. Compared with former methods, the sur-

vival rate of the glass eel in greenhouse ponds is quite high. Furthermore, the growth rate is also remarkably high, and the culture period from glass eel to market size is substantially shortened. For these reasons the method was adopted by nearly all the eel culturists in Japan, usually in combination with the conventional method, depending on season.

The pond area under greenhouse culture ranges from 150 to 1,000 m^2 , and water depth varies between 0.6 and 0.8 m. These ponds are constructed in greenhouses which are covered by vinyl chloride sheets. Small ponds are used for glass eel culture, and larger ponds are used to culture the fish to market size. For heating, long pipes connected to a boiler are laid in the ponds. Pondwater is heated with steam or warm water which flows through the pipes. Water wheels are also provided for the purpose of supplying oxygen and removing sediment. These wheels produce a rapid current, which forces feces and food remains to be transported to the center of the ponds, where they can be drained periodically. One-third to one-fifth of the pondwater is drained daily with the sediment through a system located at the center of the pond bottom. Except for the removal of sediments, there is no other special device employed for water treatment. Usually, phytoplankton does not propagate in these ponds. Water temperature is regulated at the desired level ranging between 20 and 32°C. The stocking density is about 6-15 kg/m^2 , which is much higher than that used in conventional stagnant-water culture. The quality of well water and pondwater in greenhouses of fish farms of the Aichi Prefecture is shown in Table 2 (Chiba 1980). Dissolved oxygen levels were rather low in these ponds and were usually below the saturation level, ranging from 40 to 90% saturation. In a few cases phytoplankton populations thrived, causing oxygen supersaturation. Concentrations of $\text{NH}_4\text{-N}$, $\text{NO}_2\text{-N}$, and $\text{PO}_4\text{-P}$ were also extremely high. These water-quality conditions have not been previously observed in the conventional eel culture ponds.

In these greenhouse ponds, however, eels lost their appetite only when the dissolved oxygen levels were very low. On the other hand, it is surprising to note that at remarkably high levels of $\text{NH}_4\text{-N}$, $\text{NO}_2\text{-N}$, or $\text{PO}_4\text{-P}$, eels never showed reduced appetite as long as dissolved oxygen was maintained at high levels. Thus, a decrease in oxygen concentration was more harmful to fish than an increase

Table 2
Water quality of wellwater and pondwater (greenhouse) of fish farms at Aichi Prefecture.

Item	Wellwater source			Pondwater source		
	Max.	Min.	Mean	Max.	Min.	Mean
Water temperature (°C)	21.8	17.1	19.40	27.5	20.0	25.49
pH	7.4	6.3	7.01	7.07	7.1	7.37
DO (%)	61.4	18.8	39.43	156.7	26.1	72.04
NH ₄ -N ppm	2.750	ND	1.4450	26.400	0.080	6.3050
NO ₂ -N ppm	0.080	ND	0.0141	6.000	0.020	1.2400
NO ₃ -N ppm	8.40	0.94	4.701	24.00	5.60	11.26
PO ₄ -P ppm	0.132	ND	0.0811	2.575	0.150	0.8767
COD ppm	0.54	0	0.066	7.48	1.34	6.300
COD ppm*	—	—	—	3.92	0.65	2.101
Alkalinity (mg/L)	3.750	0.682	1.6716	3.364	0.682	1.3689
Ca ppm	630	61	268.1	452	199	183.9
Mg ppm	210	43	139.9	222	18	106.5
Fe ppm	6.56	0.04	1.556	0.40	0.10	0.203
So ppm	314	19	163.9	274	18	106.9
Cl ppm	3082	228	1678.0	2340	190	1093.0
Na ppm	970	65	444.4	—	—	—
K ppm	22.0	6.5	14.90	—	—	—

COD = chemical oxygen demand.

DO = dissolved oxygen.

*Sample was filtered by 0.1- μ filter.

of NH₄-N, NO₂-N, and PO₄-P. It is important to maintain a high oxygen concentration at all times while using this culture method. Examples of production conditions and results of eel culture in heated greenhouse water ponds are shown in Table 3 (Chiba 1980). Fish grown to table size are usually harvested intermittently, and young fish are restocked or transferred between ponds several times during the culture period. Therefore, it is very difficult to correctly evaluate the production results of fish culture. In general, the feed conversion efficiency can serve as a reasonable indicator of system performance under practical culture conditions. Feed conversion efficiency is calculated as follows: weight gain multiplied by 100 and divided by amount of food given. In general, the average feed conversion efficiency in conventional stagnant-water culture is estimated to be about 60-70%. As the figures obtained in greenhouse ponds surveyed ranged between 58.7 and 71.4%, results in these ponds were not different from those in conventional stagnant-water ponds. Therefore, it seems reasonable to assume that the extremely high concentrations of several water quality factors in greenhouse ponds might not have appreciably influenced feeding or growth of eels.

However, for further development of this culture method, it is necessary to clarify the effect of the most important water quality factors, not only on fish appetite and growth but also on the physiological condition of the fish. Also, effective removal of sediment seems to be an important technique in pond management using this culture method. Therefore, the effect of sediment removal on water quality, fish growth, and appetite should be studied in detail.

Growth-limiting factors

There are many reports on the effects of organic and inorganic substances on aquatic animals; however, most are from the standpoint of pollution problems. Only a few studies have tried to clarify the effects of various water-quality parameters on fish appetite and growth. Dissolved oxygen, waste products (Kawamoto 1957),

Table 3
Examples of results of eel culture in heated-water pond (greenhouse).

		Fish pond			
		0 - 1*	0 - 2	K _A	F
Pond area	(m ²)	297	396	496	264
Water temperature	(°C)	21	24	26	24
Culturing period 1977-78		10/28	10/27	10/18	11/2
(calendar month)		3/6	6/23	1/10	6/21
Amount of fish stocked	(kg)	670	1,570	2,000	2,625
(initial)					
Amount of fish restocked	(kg)	454	2,100	0	0
Total amount of fish stocked	(kg)	1,124	3,670	2,000	2,625
Initial stocking density	(kg/m ²)	2.26	3.96	4.33	9.94
Harvest of marketable sized fishes	(kg)	0	5,942	2,985	2,547
Fish left in ponds**	(kg)	1,300	1,860	828	2,970
Dead fishes	(kg)	43	110	—	—
Weight increase	(kg)	219	4,242	1,813	2,829
Amount of feeding	(kg)	627	7,222	2,540	4,700
Feed efficiency***	(%)	35.0	58.7	71.4	61.5

*Seedling culture of eel.

**Fishes too small to be harvested.

***Feed efficiency was estimated from 35 to 71.4%, no different from those of ordinary cultured method.

NH₄-N, NO₂-N, and NO₃-N have been reported as limiting factors for fish growth. Their effective concentration ranges are shown in Table 4.

Growth rate, feeding rate, and feed conversion efficiency in many fish species decreases with a decrease of dissolved oxygen. These effects were found to occur in common carp when the oxygen concentration decreases to values less than 3 mL/L (20-23°C, or 50% of air saturation) (Chiba 1965c), for coho salmon at less than 4 ppm

Table 4
Toxic factors affecting aquatic animal life.

	Fish	Critical value	Observation	Author
Dissolved oxygen	common carp	50%	Decrease in growth rate feeding rate feed conversion efficiency	Chiba 1965c
	coho salmon	45%		Herrmann et al. 1962
	largemouth bass	49%		Stewart et al. 1967
	northern pike	32 - 43%		Adelman and Smith 1970
	eel	54%		Yamagata et al. 1983
NH ₄ -N	eel	20 ppm (NH ₃ -N 0.067-0.124 ppm)	Decrease in growth rate	Yamagata and Niwa 1982
	ayu-fish	5 ppm (NH ₃ -N 0.13 ppm)	Decrease in growth rate	Tokushima Pref. 1977
	channel catfish	30 ppm (NH ₃ -N 0.58-7.48 ppm)	Stop feeding	Knepp and Arkin 1973
NO ₂ -N	rainbow trout	0.15 ppm	Mortality 58% within 48 hr methemoglobinemia	Smith and Williams 1974
	rainbow trout	0.55 ppm	Mortality 40% within 24 hr methemoglobinemia	Smith and Williams 1974
	chinook salmon	5.0 ppm	Mortality 100% in 7 days	Westin 1974
	eel	30 ppm 30 ppm	Decrease in growth rate methemoglobinemia	Yamagata and Niwa 1979 Amano et al. 1981
NO ₃ -N	chinook salmon	4,000 ppm in freshwater 4,800 ppm in seawater	Mortality 100% in 7 days	Westin 1974
	rainbow trout	4,000 ppm in freshwater 4,700 ppm in seawater		

(20°C, 45%) (Herrmann et al. 1962), for largemouth bass at less than 4 ppm (26°C, 49%) (Stewart et al. 1967), for northern pike at less than 3-4 ppm (18.7°C, 32-43%) (Adelman and Smith 1970), and for eel at less than 4.5 ppm (25°C, 54%) (Yamagata et al. 1983). Itazawa (1971) reported that low ambient dissolved oxygen can cause a decrease in the oxygen level of arterial blood, starting at 63% saturation in rainbow trout, 50% saturation in carp, and 31% saturation in eels. Such dissolved oxygen levels were almost identical with those that reduced growth rates in rainbow trout, carp, and eels. It was assumed that fish failed to acquire a satisfactory amount of oxygen from the ambient water to meet their requirements. This caused poor appetite and a decrease in growth rate.

There are many reports of toxicity of ammonia to aquatic animal life (EIFAC 1973). It is generally believed that un-ionized ammonia is toxic and the toxicity of total ammonia changes remarkably with pH and temperature, because of an increase in the un-ionized fraction. However, there are few reports on the effect of un-ionized ammonia on fish growth. Yamagata and Niwa (1982) reported that a decrease in growth rate was observed in eels at 20-40 ppm NH₄-N (25°C, pH 6.6-6.7). Based on water temperature and pH value, the un-ionized ammonia fraction of this total ammonia concentration was calculated to be 0.067-0.121 ppm as NH₃-N. For ayu, a decrease in growth rate was observed at 5 ppm NH₄-N (25°C, pH 7.6-7.8), resulting in an un-ionized ammonia concentration of 0.13 ppm as NH₃-N (Tokushima Prefect. 1977). For channel catfish, feeding stopped at 27.3-32.0 ppm NH₄-N (21.1-22.8°C, pH 7.7-8.8) which resulted in NH₃-N values of 0.58-7.48 ppm (Knepp and Arkin 1973).

Concerning nitrite, rainbow trout developed methemoglobinemia at concentrations below 0.15 and 0.55 ppm NO₂-N, and mortality of 58% and 40% occurred after 48 hours and 24 hours, respectively (Smith and Williams 1974). It was also reported that chinook salmon died in 7 days at concentrations of NO₂-N of 5.0 ppm

(Westin 1974). When eels were kept in water at a 20-ppm concentration of NO₂-N, all fish developed methemoglobinemia (Amano et al. 1981). Regarding nitrate, it was reported that chinook salmon died within 7 days at a concentration of about 4,000-4,800 ppm NO₃-N in seawater and freshwater, and rainbow trout died at a concentration of about 4,000-4,700 ppm NO₃-N (Westin 1974).

Besides the water-quality parameters mentioned above, there are several other growth-limiting factors, such as stocking density, competition for food and space, cannibalism, size hierarchy, light conditions, and water temperature. However, some of these factors can be controlled artificially. Sometimes it is observed that even though the concentrations of these water-quality parameters are within the favorable range, fish lose appetite. This often occurs in stagnant-water eel culture ponds. There might be other unknown factors affecting fish growth and appetite. For the development of adequate water-quality management in fish culture ponds, much effort is needed in the future to find out those unknown factors.

Cycles of nitrogen, carbon, and phosphorus in fish ponds

The elements in feeds, such as nitrogen, carbon, and phosphorus, are recycled in ponds by the processes of decomposition and utilization, through activities of bacteria and phytoplankton. However, studies on the cycles of these elements in fish culture ponds are scarce. Experimental work was carried out by the present author to clarify the cycles of nitrogen, carbon, and phosphorus in eel ponds. It was found that about 14-25% of total nitrogen contained in feeds was converted by the fish (Table 5) (Chiba 1983). The percentages of crude protein contained in whole fish and in commercial feed used in this experiment were both about 50% on a dry weight basis. Eel culturists generally believe that the conver-

Table 5
Increment of nitrogen, carbon, and phosphorus in each item (gr) and percentages (in parentheses) of those in given feed.

Item	Tank P - 1			Tank P - 2			Tank P - 3		
	N	C	P	N	C	P	N	C	P
Food given	1,375 (100)	7,300 (100)	404 (100)	624 (100)	3,315 (100)	183 (100)	489 (100)	2,596 (100)	144 (100)
Eel	304 (20.1)	1,562 (21.4)	80 (19.8)	158 (25.3)	780 (23.5)	36 (19.7)	70 (14.3)	344 (13.3)	16 (11.1)
Sediment	107 (7.8)	670 (9.2)	200 (49.5)	81 (13.0)	542 (16.4)	87 (47.5)	49 (10.0)	319 (12.3)	57 (39.6)
Particulate	92 (6.7)	595 (8.2)	22 (5.3)	188 (30.1)	986 (29.7)	9 (4.9)	60 (12.3)	376 (14.5)	12 (8.6)
Soluble	207 (15.1)	312 (4.3)	12 (2.9)	159 (25.5)	281 (8.5)	10 (5.5)	140 (28.6)	168 (6.5)	6 (4.1)
Total	710 (51.6)	3,139 (43.0)	314 (77.6)	586 (93.9)	2,589 (78.1)	142 (77.7)	319 (65.2)	1,207 (46.5)	91 (63.4)

sion efficiency of commercial feeds is between 60 and 70%. Therefore, when these values are calculated on a dry weight basis, 20 to 25% of the nitrogen can be converted to fish body from feeds. The figures obtained from this experiment were nearly identical to those of eel farmers. Therefore, 75-86% of the nitrogen is transformed to other forms such as soluble substances, particulate suspended matter, and organic sediments. The percentages of nitrogen which were converted from feed to soluble substances ranged between 15 and 29%, between 7 and 30% to particulate matter, and between 8 and 10% to sediments. As for carbon and phosphorus, similar results were obtained. Only 13-24% of total carbon and 11-20% of phosphorus in the given feeds were converted to fish, but the major part of these elements was transferred to soluble and particulate matter, and to bottom sediment.

In running-water ponds, the soluble and particulate matter and organic sediments are carried away by the outflowing water. In stagnant-water ponds and recirculation-system ponds, they accumulate in the pondwater, at the pond bottom, and/or in the filter bed. When fish are stocked at high density, the accumulation rate of these substances will be extremely accelerated.

It can be concluded from these results that only 20-25% of elements such as nitrogen, carbon, and phosphorus in feeds supplied to fish were converted into fish body, and the rest was not utilized, but was accumulated in the ponds. These figures, however, were obtained from three experiments lasting less than one month. The conversion figures from feed to fish are believed to be nearly constant over a wide range of fish sizes and also independent of the experimental period, since feed-conversion efficiency is usually at the same level. However, the other figures, such as the percentages transferred from feeds to soluble fractions or to particulate suspended solids and to sediments, can vary substantially depending on the experimental period. These figures can also be influenced by bacterial activity, fish density, amount of daily feed offered, and fish culture methods employed.

In order to improve existing methods and to develop new water-quality management strategies for eel pond culture in the future, further detailed studies are needed on nutrient budgets and element cycling in the ponds.

Conclusions

In order to increase fish-pond production, a number of management efforts must be made to increase stocking density in all fish-culture methods practiced today. When the stocking density is increased, dissolved oxygen level decreases, whereas concentrations of $\text{NH}_4\text{-N}$, $\text{NO}_2\text{-N}$, and organic substances increase and the value of chemical oxygen demand elevates. To counteract dissolved oxygen depletion, water wheels or other aeration systems with blowers must be used to accelerate the transfer of oxygen from the atmosphere. However, against the accumulation of $\text{NH}_4\text{-N}$, $\text{NO}_2\text{-N}$, and organic substances and the elevation of the chemical-oxygen-demand value, no particular countermeasures are presently undertaken, except dilution through the introduction of fresh-water. Special attention should be paid to the pollution load and subsequent water quality deterioration in greenhouse ponds which are highly loaded with inorganic and organic substances. However, the fact that eels still can be produced on a commercial scale under such water-quality conditions provides several suggestions for water-quality management in these fish ponds. On one hand, eels may be relatively tolerant to water that contains appreciable concentrations of $\text{NH}_4\text{-N}$, $\text{NO}_2\text{-N}$, and organic substances. However, in order to maximize production, it will be necessary to clarify the importance of factors that affect feeding and growth of all fish species cultured, when oxygen concentrations are kept above critical levels.

In conclusion, further studies as described below are necessary to improve pondwater-quality management in order to effectively utilize water in fish culture:

1. Improvement of methods for effective oxygen transfer into water;
2. Clarification of factors which have negative effects on fish production under sufficient oxygen conditions, including their critical values for normal growth and feeding;
3. Development of treatment procedures for culture effluents which contain highly enriched organic matter, in order to avoid water pollution in rivers, lakes, and the sea.

Citations

- Adelman, L.R., and L.L. Smith.**
1970. Effect of oxygen on growth and food conversion efficiency of northern pike. *Prog. Fish Cult.* 32:93-96.
- Amano, H., T. Miyazaki, M. Ichikawa, M. Niwa, and S.S. Kubota.**
1981. Occurrence of nitrite-induced methemoglobinemia in cultured eels. *Bull. Jpn. Soc. Sci. Fish.* 47:823.
- Chiba, K.**
1965a. Freshwater fish culture from the viewpoint of stocking density. *Aquiculture (Sendai)* 4:43-47 (in Jpn.). See *Suisan Zoshoku (Fish. Cult.)*.
1965b. Studies on the carp culture in running water pond - I. Fish production and its environmental condition in a certain fish farm in Gumma Prefecture. *Bull. Freshwater Fish. Res. Lab. (Tokyo)* 15:13-33.
1965c. A study on the influence of oxygen concentration on the growth of juvenile common carp. *Bull. Freshwater Fish. Res. Lab. (Tokyo)* 15:35-47.
1980. Water quality as an environmental factor and growth of fish - V. Water quality and eel production in the heated culture pond in greenhouse. *Aquiculture (Sendai)* 28:39-45 (in Jpn.). See *Suisan Zoshoku (Fish. Cult.)*.
1983. Cycle of nitrogen, carbon and phosphorus in stagnant water eel pond. *In Proceedings, 12th annual meeting of eel culture research conference*, p. 141-148 (in Jpn.).
- EIFAC (Eur. Inland Fish. Advis. Comm.)**
1973. Water quality criteria for European freshwater fish. Report on ammonia and inland fisheries. *Water Res.* 7:1011-1022.
- Herrmann, R.B., C.E. Warren, and P. Doudoroff.**
1962. Influence of oxygen concentration on the growth of coho salmon. *Trans. Am. Fish. Soc.* 91:155-167.
- Hirano, R.**
1967. Environmental condition in freshwater fish culture pond - I. *Dohyaku-Kenkyu* 4, p. 12-16 (in Jpn.).
- Itazawa, Y.**
1971. An estimation of the minimum level of dissolved oxygen in the water required for normal life of fish. *Bull. Jpn. Soc. Sci. Fish.* 37:237-276.
- Kawai, A., Y. Yoshida, and M. Kimata.**
1964. Biochemical studies on the bacteria in aquarium with circulating system - I. Changes of the qualities of breeding water and bacterial population of the aquarium during fish cultivation. *Bull. Jpn. Soc. Sci. Fish.* 30:55-62.
- Kawamoto, N.**
1957. On the productivity of intensive carp culture pond. *Suisangakushusei*: 717-720. Tokyo Daigaku Shuppankai, Tokyo (in Jpn.).
- Knepp, G.L., and G.F. Arkin.**
1973. Ammonia toxicity levels and nitrate tolerance of channel catfish. *Prog. Fish. Cult.* 35:221-224.
- Mie Prefectural Inland Fisheries Experiment Station.**
1978. Survey of present eel culture situation. Report of effective water utilization for aquaculture, p. 1-26 (in Jpn.).
- Nakamura, N.**
1963. General problem of carp. *Proceedings, Zenkoku kosho kasen yoshoku kenkyu kai*, No. 36, p. 25-41 (in Jpn.).
- Shirahata, S.**
1964. Problems of water quality in food trout production. *Bull. Fac. Fish. Nagasaki Univ.* 17:68-82.
- Shizuoka Prefectural Fisheries Experiment Station, Hamanako Branch.**
1978. Diurnal changes of water quality in "ayu-fish" culture pond. *Proceedings, Ayu yogyo yosui kodo riyo kenkyukai*, No. 2, p. 23-27 (in Jpn.).
- Smith, C.G., and W.G. Williams.**
1974. Experimental nitrate toxicity in rainbow trout and chinook salmon. *Trans. Am. Fish. Soc.* 103:389-390.
- Stewart, N.E., D.L. Shumway, and P. Doudoroff.**
1967. Influence of oxygen concentration on the growth of juvenile largemouth bass. *J. Fish. Res. Board Can.* 24:475-495.
- Tanaka, S.**
1976. Studies on the recirculation system for fish culture - VI. Culture experiment with European eel. *Saitamaken Suisan Shikenjo Kenkyu Hokoku*, no. 35, p. 62-64 (in Jpn.).
- Tokushima Prefectural Fisheries Experiment Station, Naruto Branch.**
1977. Effect of ammonium-nitrogen on the growth of ayu-fish. *Proceedings, Ayu yogyo yosui kodoriyo kenkyukai*, no. 1, p. 26-28 (in Jpn.).
1978. Present situation of "ayu-fish" culture. *Proceedings, Ayu yogyo yosui kodoriyo kenkyukai*, no. 3, p. 32-35 (in Jpn.).
- Westin, D.T.**
1974. Nitrate and nitrite toxicity to salmonid fishes. *Prog. Fish Cult.* 36:86-89.
- Yamagata, Y., and M. Niwa.**
1979. The toxicity of nitrite to eel. *Aquiculture (Sendai)* 27:5-11 (in Jpn.). See *Suisan Zoshoku (Fish. Cult.)*.
1982. Acute and chronic toxicity of ammonia to eel *Anguilla japonica*. *Bull. Jpn. Soc. Sci. Fish.* 48:171-176.
- Yamagata, Y., S. Oonaka, M. Harada, and M. Niwa.**
1983. Influence of concentration of dissolved oxygen on the growth of Japanese eel *Anguilla japonica*. *Bull. Jpn. Soc. Sci. Fish.* 49:1335-1339.

Environmental management of larval rearing of marine fishes—A short history of research to prevent lordosis in red sea bream, *Pagrus major*

KUNIIHIKO FUKUSHO

National Research Institute of Aquaculture
Fisheries Agency
Nansei, Mie, 516-01 Japan

CHIKARA KITAJIMA¹

Laboratory of Aquaculture
Nagasaki Prefectural Institute of Fisheries
Nomozaki, Nagasaki, 851-05 Japan

The technology for mass larval rearing of marine fishes has developed remarkably over the last 15 years. For example, 6.3×10^6 juvenile red sea bream, *Pagrus major*, and porgy, *Acanthopagrus schlegeli*, 12.1-16.0 mm TL, were produced in a hatchery within a three-month period (Fushimi 1984). There have been several reasons for the rapid and successful development of these techniques. One of the most important is the introduction of the rotifer *Brachionus plicatilis* as a food organism, and the development of its culture (Fushimi 1984). Establishment of natural spawning in tanks is another important factor. A female red sea bream of 1-1.5 kg spawns $2-3.5 \times 10^6$ eggs during a period of 1.5 months (Kitajima 1978, 1983). Furthermore, special attention to improving environmental management for larval rearing and mass culture of the rotifer promoted development of fry production techniques. Thus, it has become possible to rear fry in large-scale 100-ton tanks, with a harvest of 10^6 juveniles of 10 mm TL, and mass culture rotifers in 40-ton tanks, with a harvest of 152.4×10^8 rotifers, or 45 kg for 18 days (Fukusho 1979). This paper deals with the importance of environmental management in larval rearing of marine fishes, illustrating the serious problem of lordosis in red sea bream and the history of research aimed at its solution as an example of successful environmental management.

Lordosis, a vertebral abnormality frequently observed (30-50%) in hatchery-reared red sea bream and other species such as the porgy, *A. schlegeli*, and silver bream, *Sparus sarba*, is the most serious of several kinds of deformities, i.e., scoliosis, incomplete development of opercle bones, and pug head (Sumita 1977, Kitajima 1978, Takashima 1978, Fujita 1979, Fujita and Kitajima 1978). Lordosis, causing a V-shaped vertebral column, is known to be induced in fish and uninflated swim bladders (Kitajima et al. 1977, Paperna 1978, Takashima et al. 1980, Iseda 1982). External characteristics of lordosis will gradually appear in adults during growth, although it is actually induced in the early larval stages. Subsequently, the abnormal features of lordosis reduce the commercial value of red sea bream, despite the long-term farming efforts of the aquaculturists.

In a search for the cause of lordosis, three fields of study were explored: 1) genetics, 2) nutrition, and 3) environmental improvement.

Genetic problems

For the investigation of genetic factors, eggs were sent from one hatchery to a second hatchery where lordosis had rarely been observed, and newly-hatched larvae from the same spawning were reared at the two hatcheries (Fujita and Kitajima 1978, Kitajima 1978). Deformed individuals never appeared at the second hatchery, while lordosis was found at the first hatchery at a rate of 14.1-35.4% (Fujita and Kitajima 1978). The percentage of lordosis varied among experimental tanks with eggs from the same parent fish. Lordosis has occurred in almost all hatcheries in Japan, with a few exceptions. Thus, a genetic cause of lordosis might be ruled out, although there are data to suggest that the deformity may be caused by prehatching factors, such as physiological condition of the eggs and brood stock (Taniguchi et al. 1984).

¹Current address: Fisheries Research Laboratory, Kyushu University, Tsuyazaki, Munakata-gun, Fukuoka, 811-33 Japan.

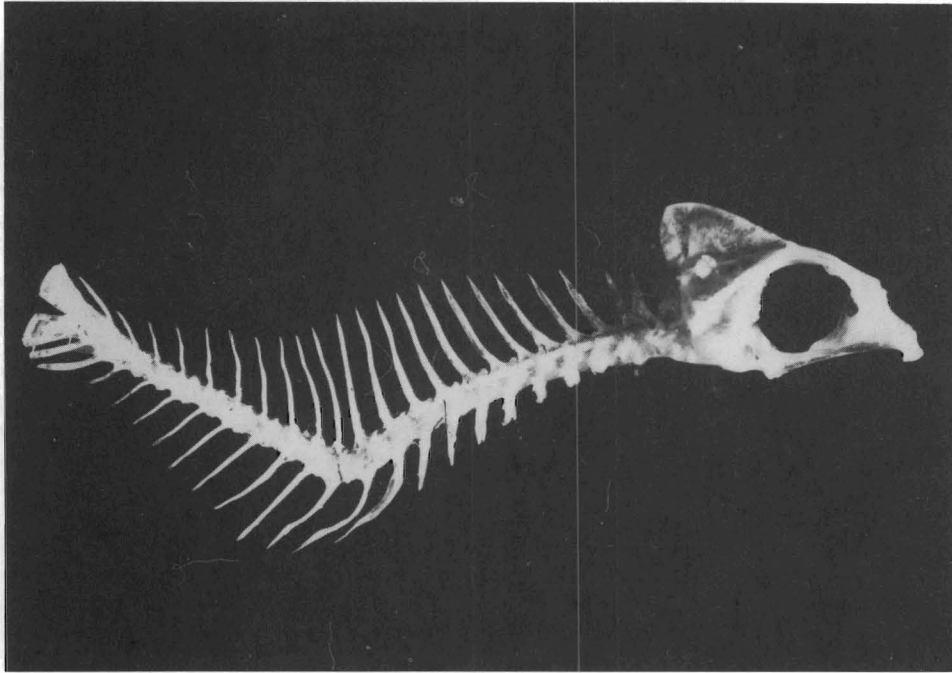
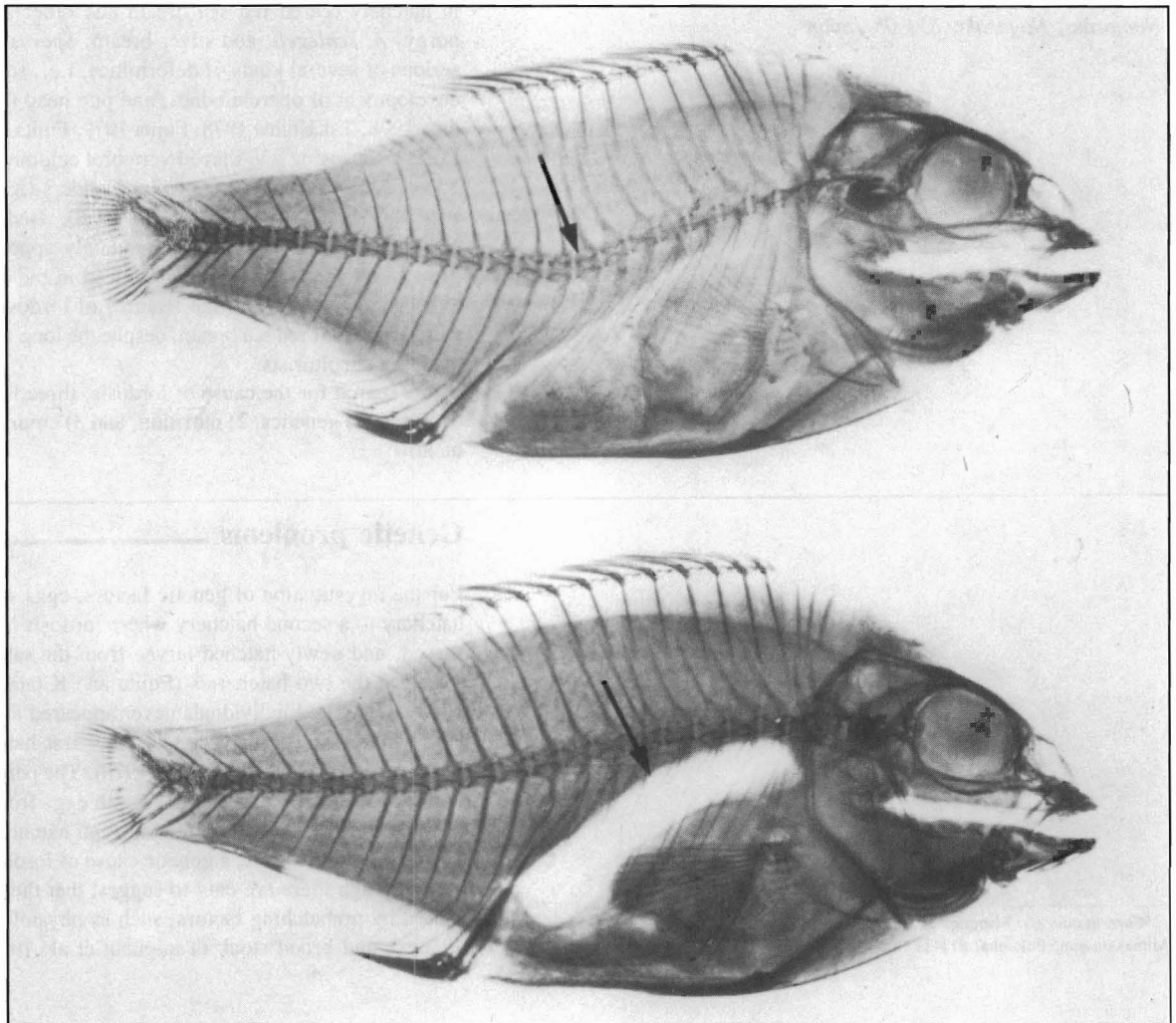

Figure 1
Deformed backbone (lordosis) of cultured red sea bream, *Pagrus major*.

Figure 2
Lordosis in hatchery-reared red sea bream well correlated with development of a swim bladder. (Top) A deformed backbone with undeveloped swim bladder. (Bottom) A normal backbone with a well inflated swim bladder.



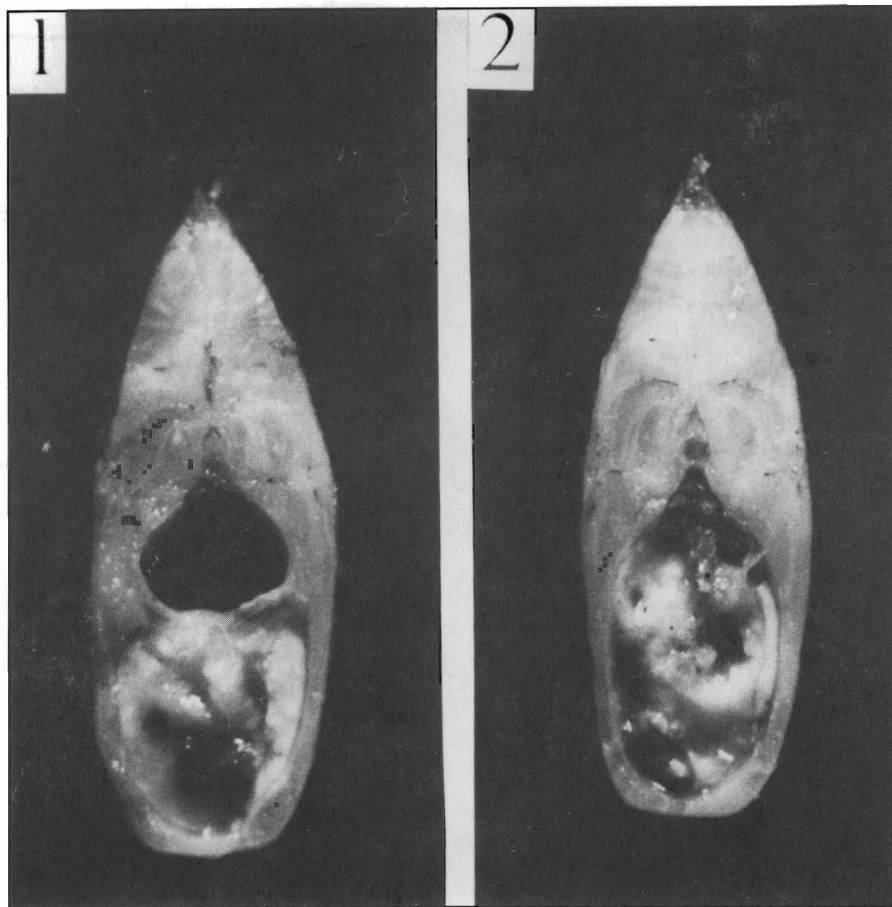

Figure 3

Cross section of trunk in red sea bream. (Left) A normal fish with a well inflated swim bladder; (Right) An abnormal fish with undeveloped swim bladder.

Nutritional value of initial larval feeds

Omega-3 highly unsaturated fatty acids (ω -3HUFA) such as 20:5 ω -3 are important for survival and growth of marine fish larvae (Watanabe et al. 1983). Some rearing experiments suggest that development of the swim bladder is affected by the quality of initial feeds (Fujita and Kitajima 1978, Watanabe 1978). Rearing groups fed on rotifers cultured with baker's yeast (ω -3HUFA deficient) have a tendency to exhibit a higher ratio of juveniles with uninflated swim bladders. On the contrary, groups fed on rotifers cultured with *Chlorella*, or special yeast with assimilated ω -3HUFA, have lower ratios on abnormal swim bladders. Thus nutritional improvement may reduce the deformations (Fujita and Kitajima 1978, Watanabe 1978). However, the percentage of lordosis varies among fish groups given the same feeds.

Agricultural chemicals and phosphorus

The influence of agricultural chemicals and other poisonous substances in the rearing water (Seikai 1982) and in food organisms such as *Artemia salina* (Bookhout and Costlow 1970, Fujita and Kitajima 1978) were suspected of inducing lordosis, but precise

investigation of their influence has not been conducted. The content of phosphorus in seawater was pointed out as an important factor in bone formation. Larvae have been reared in various concentrations of phosphorus, but consistent results were not obtained.

Handling of larvae and depth of rearing water

Seed production of finfish can be divided into two phases: 1) larval or primary rearing (3-10 mm TL fed mainly live food organisms and held in concrete tanks), and 2) juvenile or secondary rearing (10-30 mm TL fed mainly minced fish and held in fine-mesh net cages hanging from rafts). Transfer of larvae into net cages from concrete tanks is hard and troublesome work sometimes involving a siphoning method. Shocks to larvae during the siphoning process have been considered a cause of deformations; however, no difference in occurrence of deformity was found among fish subjected to siphoning, provided there was careful handling with buckets and continuous rearing in concrete tanks up to the juvenile stage without transfer. Thus, shock through handling was ruled out as a cause of lordosis (Fujita and Kitajima 1978). The influence of depth of the rearing tank was also examined, and a lower incidence of lordosis was obtained in shallow water (18 cm) compared with deeper water (87 cm) (Kitajima and Tsukashima 1982).

Relationship between aeration and deformation

Optimal amounts of aeration for larval rearing were examined in 1-ton circular tanks. Lordosis was rarely found in fish groups reared at an aeration rate of 50-100 mL/minute, while a high percentage of deformity appeared in non-aerated tanks and with aeration greater than 500 mL/minute (Iseda et al. 1982). Moderate and uniform water currents led to lower percentages of lordosis and higher survival rates, even without aeration; while survival rates and percentages of fishes with inflated swim bladders were low in tanks without aeration and current. Thus, it was found that moderate current, suitable aeration, and weak sprinkling of water on the surface of rearing water during the stage of mouth opening (4-6 days after hatching) were effective methods of reducing the incidence of lordosis (Iseda 1982).

Demonstration of air gulping theory

Rhythmical movements toward the surface by larvae at the mouth-opening stage were observed by Yamashita (1963, 1982) and the significance of this behavior was evaluated in view of normal organogenesis. Also, the swim bladder was found to be inflated for short periods at the size of 3.5 mm TL, 5-6 days after hatching at a temperature of 18-22°C (Kitajima et al. 1981). According to these facts, it was considered that the abnormally developed swim bladder of larvae was due to a failure to gulp air at the surface during this early stage.

Rearing experiments were conducted to examine this hypothesis (Kitajima et al. 1981). One tank was sealed with a layer of liquid paraffin and the other left open as a control. Over 90% of the larvae had normal swim bladders at about 7 days after initial feeding (4.2 mm TL) in the control tank, whereas none were inflated in the sealed tank. Thus, it has been shown that gulping air at the surface is essential for initial swim bladder inflation (Kitajima et al. 1981). This hypothesis was proved by histological observations during the development of the swim bladder (physostomous to physoclistous stages) (Takashima et al. 1980). The importance of air gulping during the physostomous stage was also demonstrated in other species (Doroshev and Cornacchia 1979, Doroshev et al. 1981).

Larval rearing procedures for prevention of lordosis

Lordosis is rarely found in hatchery-reared red sea bream at present, since environmental conditions in larval rearing tanks have been well managed, with the application of information and techniques obtained through previous research, i.e., to (1) supply a moderate current and aeration (50-100 mL/min·ton), (2) clean the surface so that air will penetrate into the rearing water, (3) supply water with a sprinkler on the surface of rearing water, (4) introduce newly hatched larvae at fairly low stocking densities ($1-2 \times 10^4$ individuals/m³), (5) select individuals with well developed swim bladders by the method of specific gravity (Nagaike and Sasaki 1981) or phototaxis (Iseda 1982), and (6) feed the larvae with rotifers of good nutritional value.

Acknowledgments

We wish to express our sincere thanks to Warren D. Nagata and Ryo Suzuki for their critical reading of this manuscript.

Citations

- Bookhout, C.G., and J.D. Costlow, Jr.
1970. Nutritional effect of *Artemia salina* from different locations on larval development of crabs. *Helgol. Wiss. Meeresunters* 20:435-442.
- Doroshev, S.I., and J.W. Cornacchia.
1979. Initial swimbladder inflation in the larvae of *Tilapia mossambica* and *Morone saxatilis*. *Aquaculture* 16:57-66.
- Doroshev, S.I., J.W. Cornacchia, and K. Hogan.
1982. Initial swim bladder inflation in the larvae of physoclistous fishes and its importance for larval culture. *Rapp. P.-V. Reun. Cons. Int. Explor. Mer* 178:495-500.
- Fujita, S.
1979. Culture of red sea bream, *Pagrus major*, and its food. In Styczynska-Jurewicz, E., T. Backiel, E. Jaspers, and G. Persoone. (eds.), *Cultivation of Fish and Its Live Food*. Spec. publ. 4, p. 183-197. Eur. Maricult. Soc., Belgium.
- Fujita, S., and C. Kitajima.
1978. Occurrence of the lordotic deformity in larvae and juveniles of red sea bream. *Kaiyou-Kagaku (Mar. Sci. Monthly)* 107:721-727 (in Jpn.).
- Fukusho, K.
1979. Studies on fry production of Japanese striped knifejaw *Oplegnathus fasciatus*, with special reference to feeding ecology and mass culture of food organisms. Spec. rep. 6, Nagasaki Prefect. Inst. Fish., 173 p. (in Jpn., Engl. summ.).
- Fushimi, T.
1984. The present status of seedlings technology for red sea bream and black sea bream, and mechanization for their mass production. In Inoue, H., (ed.), *The Present Status of Development and Researches in Technology of Fisheries*, p. 68-79. Guzyutu Joho-Center, Osaka, Japan (in Jpn.).
- Iseda, A.
1982. Prevention of lordosis in the juvenile of red sea bream, *Pagrus major* reared in ponds - III. Relationship between the initial conditions of rearing environment and gas content. *Bull. Kumamoto Prefect. Inst. Fish.* 2:25-45 (in Jpn.).
- Iseda, H., M. Ishihara, S. Sumita, M. Owaki, and S. Tabata.
1982. Prevention of lordosis in the juvenile of red sea bream, *Pagrus major* reared in ponds - II. Relationship between the initial rearing-conditions and the lordotic deformity. *Bull. Kumamoto Prefect. Inst. Fish.* 1:9-17 (in Jpn.).
- Kitajima, C.
1978. Acquisition of fertilized eggs and mass-culture of juveniles of red sea bream, *Pagrus major*. Spec. rep. 5, Nagasaki Prefect. Inst. Fish., 92 p. (in Jpn., Engl. summ.).
1983. The present status of marine fish seed producing technique in Japan. In Fuentes, H.R., J.G. Gastilloa, and L.H. Disalbo (eds.), *International Symposium on Advances and Perspectives of Aquaculture in Chile*, p. 375-390. Universidad del Norte, Coquimbo, Chile.
- Kitajima, C., H. Iwamoto, and S. Fujita.
1977. Relationship between curvature of vertebral column and hatchery-reared undeveloped swimbladder in red sea bream, *Pagrus major*. *Bull. Nagasaki Prefect. Inst. Fish.* 8:137-140 (in Jpn.).
- Kitajima, C., Y. Tsukashima, S. Fujita, T. Watanabe, and Y. Yone.
1981. Relationship between uninflated swim bladders and lordosis deformity in hatchery-reared red sea bream *Pagrus major*. *Bull. Jpn. Soc. Sci. Fish.* 47:1289-1294 (in Jpn., Engl. summ.).
- Kitajima, C., and Y. Tsukashima.
1982. Effects of depth of the rearing tank on the incidence of swim bladder inflation of larval red sea bream, *Pagrus major*. *Bull. Nagasaki Prefect. Inst. Fish.* 8:137-140 (in Jpn.).
- Nagaike, N., and Y. Sasaki.
1981. The mass production and breeding in hatchery reared red sea bream, *Pagrus major* (Temminck and Schlegel) - I. Mass selection of fish with abnormal airbladder. *Aquiculture (Sendai)* 28:196-201 (in Jpn.). See Suisan Zoshoku (Fish. Cult.).
- Paperna, I.
1978. Swimbladder and skeletal deformation in hatchery bred *Sparus surata*. *J. Fish. Biol.* 12:109-114.

- Seikai, T.**
1982. Acute toxicity of organophosphorous insecticides on the developmental stage of eggs, larvae and juveniles of Japanese striped knifejaw, *Oplegnathus fasciatus*. Bull. Jpn. Soc. Sci. Fish. 48:599-603 (in Jpn., Engl. summ.).
- Sumita, S.**
1977. Deformations found in hatchery-reared red sea bream. Spec. rep. 46, Fish. Exp. Stn., Kumamoto Prefect., p. 33-42 (in Jpn., Engl. summ.).
- Takashima, F.**
1978. Vertebral malformation in hatchery-reared red sea bream, *Chrysophrys major*. Bull. Jpn. Soc. Sci. Fish. 44:435-443 (in Jpn., Engl. summ.).
- Takashima, F., Y. Arai, and M. Nomura.**
1980. Abnormal development of the swimbladder in hatchery-reared red sea bream, *Chrysophrys major*. J. Tokyo Univ. Fish. 67:67-73 (in Jpn., Engl. summ.).
- Taniguchi, N., K. Azuma, and S. Umeda.**
1984. Difference due to parents in incidence of vertebral malformation in artificially bred red sea bream. Bull. Jpn. Soc. Sci. Fish. 50:787-792.
- Yamashita, K.**
1963. Fundamental studies on the culture of red sea bream, *Pagrus major* - I. Ethological observation of larvae in tanks. Aquiculture (Sendai) 11:189-209 (in Jpn.). See Suisan Zoshoku (Fish. Cult.).
1982. Differentiation of the swimbladder structure in larvae of the red seabream *Pagrus major*. Jpn. J. Ichthyol. 29:193-202 (in Jpn., Engl. summ.).
- Watanabe, T.**
1978. Nutritional value of food organisms in view of lipids. In Aquaculture and Lipid in Feeds, p. 93-111. Jpn. Soc. Sci. Fish., Koseisha-Koseikaku, Tokyo (in Jpn.).
- Watanabe, T., C. Kitajima, and S. Fujita.**
1983. Nutritional value of live organisms used in Japan for mass propagations of fish: A review. Aquaculture 34:115-143.

Salinity tolerances of marine bivalves

SHOJI FUNAKOSHI
TOHRU SUZUKI
KOJI WADA

National Research Institute of Aquaculture
Fisheries Agency
Nansei, Mie, 516-01 Japan

In Japan, many kinds of bivalves have been used in a variety of recipes. These bivalves are supplied from fishing and aquaculture. The latter is divided into two methods: hanging and sowing. In the hanging method, bivalves are hung from a raft or line, and put into an environment which is different from that of their natural habitat. Thus, the species suitable for the hanging culture method must have an ability to tolerate the change of environment. In the sowing method, the environmental conditions of the culture grounds are also very important for the growth and survival of the planted bivalves. Accordingly, knowledge of the physiological and ecological characteristics of bivalves, and their limits of tolerance for environmental conditions, must be accumulated in more detail for further development of management techniques and culture methods. Previously, the relationship between habitat and osmoregulatory ability of bivalves, with special reference to free amino acids found in body fluids, was reported at the UJNR meeting in 1981 (Wada 1984). The present paper deals with shell-closing behavior of several species of bivalves and their ability to tolerate salinity changes.

Materials and methods

Experiments were carried out with 11 species of bivalves (commercial size) shown in Table 1. After collection, the bivalves were kept in basket nets at Ago bay, Mie Prefecture, for at least 1 week before use. The samples of each species were divided into two groups. One group was used for examining the behavioral response of closing the shell valves tightly after salinity changes. In the second group, a plug was inserted between shell valves to allow the external medium to enter the mantle cavity freely; this group was used for determination of salinity tolerance limits. The bivalves of each group were transferred into five containers filled with 25, 50, 100 (full-strength), 150, and 200% seawater, and maintained for 2 days. All the media were changed every day. Lower salinity media were prepared by diluting seawater with wellwater, and high salinity media by adding instant ocean salts to seawater. The experiments were conducted at water temperatures of 22-24°C with the exception of 14°C for *Patinopecten yessoensis*, which lives in cold seas.

Determination of osmotic pressure

Mantle cavity fluid, hemolymph, and the seawater medium were sampled at 2-4, 24, and 48 hrs of exposure to each medium. Their osmotic pressures were measured with a freezing-point depression osmometer (Advanced Instruments, Inc., Model 3CII).

Determination of survival

Three to five individuals of the plugged group in each medium were removed from the container to the basket net, and suspended from a raft at 2-4, 24, and 48 hrs of exposure. After one week, their survival was determined.

Table 1
Survival (%) and osmotic pressure (mOsM/kg) of hemolymph at the lowest (min.) and highest (max.) concentrations without mortality observed in the plugged bivalves after 48 hrs of exposure to various concentrations of seawater.

Species	Survival						Osmotic pressure of hemolymph	
	Concentration of seawater (osmotic pressure)						Min.	Max.
	25% (240)	50% (480)	75% (730)	100% (960)	150% (1500)	200% (2000)		
<i>Crassostrea gigas</i>	100	100	100	100	100	100	300	2000
<i>Mytilus edulis</i>	100	100	100	100	100	0	310	1460
<i>Meretrix petechialis</i>	100	100	100	100	66	33	420	960
<i>Mytilus coruscus</i>	0	100	100	100	33	0	470	960
<i>Scapharca broughtonii</i>	0	100	100	100	0	0	510	960
<i>Pinctada fucata</i>	0	0	100	100	0	0	710	960
<i>Macra</i> (M) <i>chinensis</i>	0	0	100	100	0	0	720	960
<i>Chlamys</i> (M) <i>nobilis</i>	0	0	100	100	0	0	720	960
<i>Fulvia mutica</i>	0	0	100	100	0	0	720	960
<i>Patinopecten</i> (M) <i>yessoensis</i>	0	0	66	100	0	0	960	960
<i>Pecten</i> (N) <i>albicans</i>	0	0	0	100	0	0	960	960

Results

Salinity tolerance

Table 1 shows the survival at 48 hrs of exposure to the experimental media, and the osmotic pressures of hemolymph at the lowest and highest seawater concentrations which were tolerated. Species in Table 1 are listed in order based on the range of salinity tolerance. When the plugged bivalves were put in the experimental media, their hemolymph and mantle cavity fluid soon reached osmotic equilibrium with the external medium, but the mantle cavity fluid of the oyster, *Crassostrea gigas*, the edible mussel, *Mytilus edulis*, and the clam, *Meretrix petechialis*, in the 25 and 50% seawater remained hyperosmotic to the media to some extent, because the animals prevented the medium from entering the mantle cavity by loosely closing the edges of the mantle palps.

Crassostrea gigas withstood the full range of the 25, 50, 75, 150, and 200% seawater for 48 hrs. *Mytilus edulis* survived 48 hrs of exposure to the 25, 50, 75, and 150% seawater, but all individuals had died at 24 hrs in the 200% seawater. *Meretrix petechialis* survived for 48 hrs in the 25, 50, and 75% seawater. The pearl oyster, *Pinctada fucata*, the surf clam, *Macra chinensis*, the scallop, *Chlamys nobilis*, and the cockle, *Fulvia mutica*, withstood only 75% seawater for 48 hrs, and all of them had died at 48 hrs in the 25, 50, 150, and 200% seawater. But the occurrence of mortality with time in the 50% seawater was different interspecifically. At 24 hrs exposure to 50% seawater, *P. fucata* showed 33% mortality, and *C. nobilis*, *M. chinensis*, and *F. mutica* showed 100% mortality. The scallop, *Pecten albicans*, could not withstand either diluted or concentrated seawater even for 24 hrs.

Shell-closing

Some bivalves can isolate themselves from unfavorable conditions of the environmental medium by closing their valves. This behavior was examined by measuring the osmotic pressures of the hemolymph, mantle cavity fluid, and external medium. Hemolymph was usually at osmoequilibrium with mantle cavity fluid, with exceptions observed in some species at 2-4 hrs in the 25 or 200% seawater. The results clearly indicated that the bivalves with a wide range

of salinity tolerance could isolate themselves from the external medium by tightly closing their valves for a longer time than those with a narrow range of salinity tolerance. Figure 1 indicates the results of tests with bivalves with wide (*Meretrix petechialis*), moderate (*Macra chinensis*), and narrow (*Pecten albicans*) range of salinity tolerance.

Meretrix petechialis—At 2-4 hrs of exposure to the 25, 50, 75, 150, and 200% seawater, the clams isolated themselves from the medium by closing their valves tightly, and the osmotic pressures of mantle cavity fluids were maintained at 940-960 mOsM/kg, similar to that of 100% seawater (950 mOsM/kg), regardless of the osmotic pressure of the external medium. At 48 hrs, the mantle cavity fluids became almost isotonic to the external medium in the 50 and 75% seawater; however, both in the 25 and 200% seawater, the mantle cavity fluids were still kept hyperosmotic and hypotonic to each external medium by closing the valves tightly.

Macra chinensis—In the 150 and 200% seawater, the mantle cavity fluids became isosmotic to each external medium at 2-4 hrs. The animals did not isolate themselves from these high-salinity media even for 2-4 hrs by closing their valves. After 2-4 hrs of exposure to the 75% seawater, in which the clams could survive for at least 48 hrs, the mantle cavity fluids became also isosmotic to the 75% seawater. However, in the 25 and 50% seawater, the mantle cavity fluids were hyperosmotic to the media at that time. The mantle cavity fluids at 24 hrs of exposure to the experimental media were isosmotic to each medium, with the exception of a slightly hyperosmotic state observed in 25% seawater.

Pecten albicans—In the 25, 50, 75, 150, and 200% seawater, the mantle cavity fluids were isosmotic to the external media at 2-4 hrs of exposure, with one exception out of three scallops which maintained a hyperosmotic state in the 50% seawater. Most scallops could not close their valves tightly even for 2-4 hrs with the sudden salinity changes.

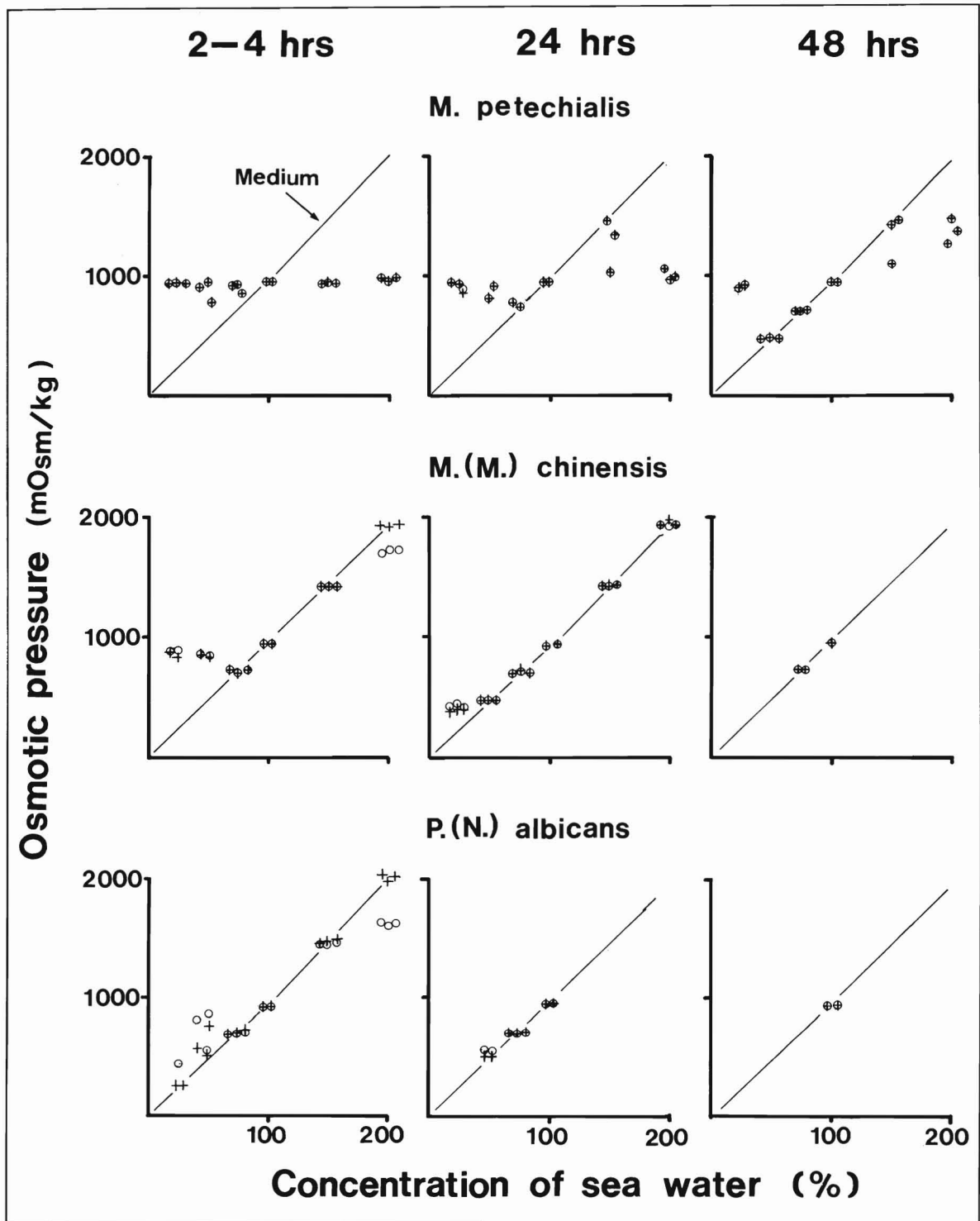

Figure 1

Changes in the osmotic pressure of the hemolymph (o) and the mantle cavity (+) of *Meretrix petechialis*, *Maetra (M.) chinensis*, and *Pecten (N.) albicans* at 2-4, 24, and 48 hrs of exposure to 25, 50, 75, 100, 150, and 200% seawater.

Discussion

Marine bivalves are osmoconformers. Their hemolymph is in osmo-equilibrium with the external medium. They can adapt to environmental salinity changes by regulating the concentrations of ions and intracellular free amino acids (Robertson 1964, Somero and Bowlus 1983). The range of salinity tolerance, however, is different among species and affected mainly by the size of the free amino-acid pool available for intracellular volume regulation (Gainey and Greenberg 1977).

When salinity changes occur in the environmental medium, besides the adjustment by metabolic regulation mentioned above, bivalves can also close their valves tightly, retreat into burrows, or escape from unfavorable salinity by swimming, depending on their capabilities for movement.

The habitats of the bivalves used in this experiment are as follows. *Crassostrea gigas* is common in the intertidal zone and attaches to rocks. *Mytilus edulis* and *Meretrix petechialis* live from the intertidal zone to the upper part of the infralittoral zone where the salinity is changeable. The former is an attached surface-dweller and the latter a sandybottom burrower. *Mytilus coruscus* and *Pinctada fucata* live in the upper part of the infralittoral zone and are surface dwellers. *Chlamys nobilis* is found in the upper part of the infralittoral zone and lives freely or attaches only weakly to the bottom surface by byssus threads. *Macra chinensis*, *Scapharca broughtonii*, and *Fulvia mutica* are bottom burrowers in the upper to middle part of the infralittoral zone. *Patinopecten yessoensis* and *Pecten albicans* live freely on the bottom surface in the middle to lower part of the infralittoral zone.

Crassostrea gigas, *M. petechialis*, and *M. edulis* live in the intertidal zone or shallow water with changeable salinity. They can withstand a wide range of salinity, and were found to be able to close the shell valves tightly for a long time. On the contrary, *P. yessoensis* and *P. albicans* were found to withstand diluted or concentrated seawater media poorly, due to lack of ability to close their valves tightly and continuously for a long time. Consequently, the following conclusions were reached. Bivalves living in the intertidal zone and shallow water with changeable salinity can wait for recovery of salinity by closing their valves tightly after sudden salinity change of ambient water, and can also adapt themselves to a wide range of salinity by metabolic regulation. The bivalves, which live in the lower part of the infralittoral zone and can also swim with well developed adductor muscle and mantle palps, have poor metabolic abilities for osmoregulation, but they can escape from unfavorable salinity conditions by swimming.

In a long evolutionary history, in which bivalves have dispersed into various habitats, they have adaptively acquired the metabolic function and behavior suitable for these habitats. The knowledge of physiological and ecological characteristics will provide valuable information for the development of culture techniques. For example, the abovementioned knowledge of behavior in the presence of salinity changes could be useful in the search for suitable culture grounds and in the management of culture by the hanging method. The knowledge about shell-closing ability has been used in brine treatment (Waki and Yamaguchi 1964) to exterminate the mud worm, *Polydora*, which penetrates the shells of pearl oysters. An outline of the treatment is as follows: The pearl oyster is first dipped into freshwater for 15 minutes to make shell valves close tightly, and then in 22% brine for 20 minutes. By this treatment *Polydora* is killed without any mortality of the pearl oyster.

Citations

- Gainey, J.F., Jr., and M.J. Greenberg.
1977. Physiological basis of the species abundance-salinity relationship in molluscs: A speculation. *Mar. Biol.* 40:41-49.
- Robertson, J.D.
1964. Osmotic and ionic regulation. *In* *Physiology of Mollusca*, Vol. 1, p. 283-308. Acad. Press, NY.
- Somero, G.N., and R.D. Bowlus.
1983. Osmolytes and metabolic end products of molluscs: The design of compatible solute system. *In* *The Mollusca*, Vol. 2, p. 77-100. Acad. Press, NY.
- Wada, K.
1984. Osmoregulation in marine bivalves. *In* Sindermann, C. J. (ed.), *Proc. 9th/10th U.S.-Japan Meetings on Aquaculture*, p. 89-92. NOAA Tech. Rep. NMFS 16 (Natl. Oceanic Atmos. Adm., Natl. Mar. Fish. Serv.), Seattle, WA 98115.
- Waki, S., and K. Yamaguchi.
1964. Extermination of mud worm, penetrating into the shell of the pearl oyster, by brine treatment. *Kaiho* 64:15-25. Natl. Fed. Pearl Cult. Co-op. Assoc. (in Jpn.).

Temperature preference of immature horse mackerel, *Trachurus japonicus*, in a vertical temperature gradient

ASTUSHI FURUKAWA¹
HIROSHI FUKATAKI
SHUJI TSUCHIDA

Marine Ecology Research Institute
Central Laboratory
Iwawada, Onjuku Isumigun,
Chiba, 299-51 Japan

In the past, there was concern in Japan that heavy mortality of fishes inhabiting coastal waters might occur when large-scale fossil fuel and nuclear power plants were constructed in order to meet the increasing demand for electric power, and huge amounts of thermal effluent would be released into coastal areas. However, mortality of fish caused by the thermal effluent has been found to be negligible in recent years. Therefore, research into thermal effects on fishes has concentrated on behavioral studies.

One of the fish behavioral programs related to thermal effluent from power plants is a study of the temperatures preferred and avoided by various fish species. The Marine Ecology Research Institute is presently conducting studies of this kind using commercially important fishes which inhabit the coastal waters of Japan. The research is conducted under laboratory conditions, with the financial support of the Japanese Government.

In the study reported here, behavior of horse mackerel, *Trachurus japonicus*, an important coastal fish, was examined in a vertical temperature-gradient aquarium.

Materials and methods

Immature horse mackerel, *Trachurus japonicus* (Temminck et Schlegel), used in this study were of culture origin. Fish cultured in fish farms in Shizuoka Prefecture were brought to the laboratory in October 1983. Fish were kept in 0.5 m³ indoor stock tanks with a continuous flow of sand-filtered seawater and fed a moist diet prepared with commercial sea bream feed supplemented by raw fish. Rearing temperature of the fish was not controlled. Holding mortality was negligible.

Prior to the experiment, the fish were randomly divided into three groups. Each group was transferred from indoor stock tanks to acclimation tanks (3 m³) located in a rearing room and acclimated to one of three temperatures (20, 25, and 28°C). Fish were acclimated to these temperature levels at a rate of 1°C per day and held at the final temperature level for at least one week. During this period, the fish were fed twice a day.

The vertical temperature gradient device used in this study has already been reported at the annual meeting of the Japanese Society of Scientific Fisheries by Fukataki and Tsuchida (1986). This device can be divided into three parts: experimental aquarium, temperature control system, and monitoring and recording system. The experimental aquarium (Fig. 1) (183 cm deep, 172 cm long, and 74 cm wide) was situated in a lightproof room. A plexiglass panel was placed in front of it through which the fish were observed by a monitoring video camera. Horizontal lines were drawn on the back panel to delineate observational zones of equal width (15 cm). These were numbered from 1 to 11 in order of decreasing depth. Total seawater volume in the aquarium was approximately 1,485 liters. Light was supplied by three pairs of 40-watt fluorescent lamps suspended over the center of the aquarium.

The temperature-controlled water entered the experimental aquarium through eleven water inflow pipes arranged at intervals of 15 cm vertically on the left side of the aquarium, and flowed out through eleven water outflow pipes on the right side of the aquarium.

The desired thermal gradient in the aquarium was determined by the temperature-control computer system (Fig. 2). Vertical water temperature profiles were measured with a series of eleven platinum

¹Present address: Yokohama-shi, Isogo-ku, Mori, 1-5-21-1036 Japan.

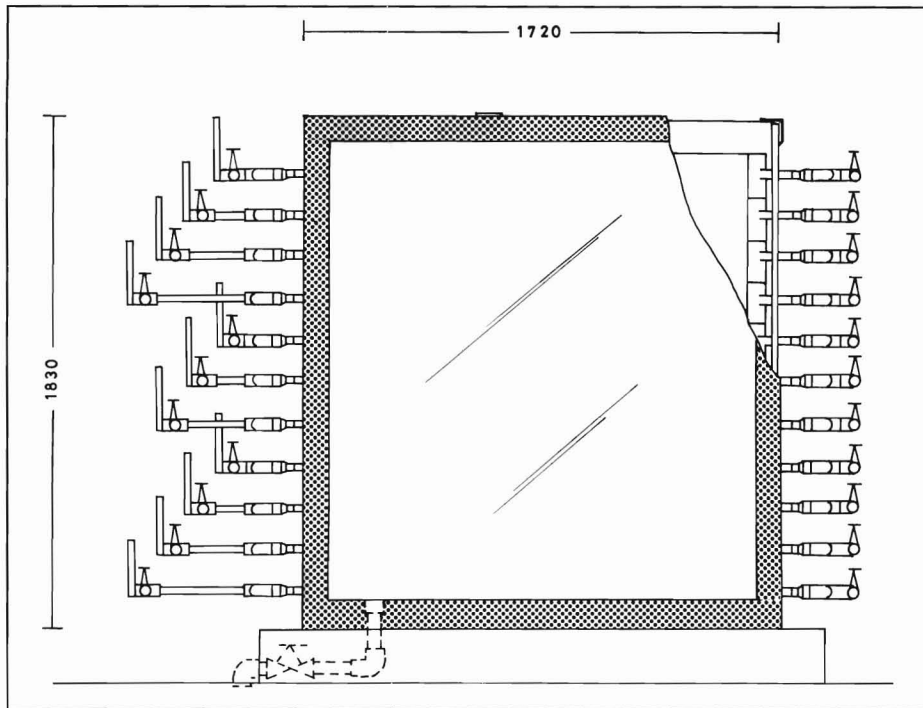

Figure 1
Schematic diagram of vertical temperature-gradient tank.

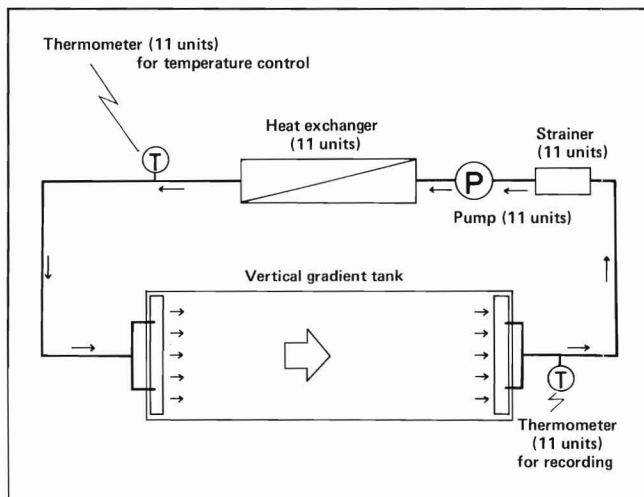

Figure 2
Schematic diagram of temperature-control system and the circulation of seawater.

resistance thermometers set in the eleven water outflow pipes. The temperature data obtained were entered in the computer.

The positions of fish in the aquarium were monitored by video camera set up in front of the aquarium, and data were entered in the computer by means of a digitizer. The thermal gradient in the aquarium could be shifted up or down by adjustment of the temperature-control system.

Procedure

At the beginning of each experiment, the initial water temperature in the experimental aquarium was adjusted to correspond with the acclimation temperatures (20, 25, and 28°C) of the particular test group. Five fish were chosen at random from one of the acclimation tanks, transferred to the experimental aquarium of the same acclimation temperature, and held there for about 24 hours. This acclimating period was necessary for fish to adjust to the new condition.

Control observations were made to evaluate fish response to absence of a temperature gradient. The vertical position of each fish was recorded and put in the computer at 3-minute intervals for 1 hour (designated a "unit"). Then a desired temperature gradient was established by circulating seawater supplied through eleven water inflow pipes of the temperature-control system following the orders of the computer. Two sets of temperature differences (20 and 10°C) between surface and bottom of the aquarium were applied in this study. The temperature gradients set in the experimental aquarium were shown as 20°C/150 cm and 10°C/150 cm, respectively, because the water depth in the aquarium was 150 cm.

A practical process of changing water temperature in the aquarium was shown in Figure 3. This process was repeated in six sets of experiments and was usually divided into eight periods as follows.

Isothermal period (IP)

1st temperature shifting period (TSP)—desired temperature gradient and range were formed.

1st stable temperature gradient period (STGP)—"20°C gradient" and the desired temperature range continued for 1 hour.

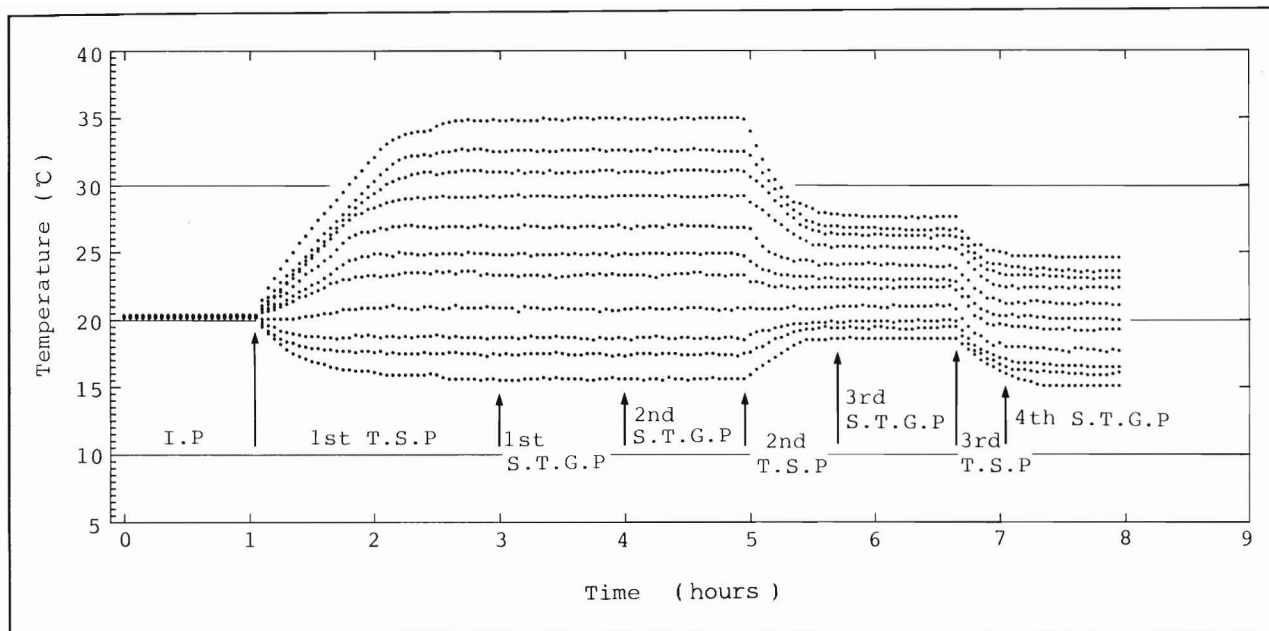

Figure 3

Process of temperature change in each zone. IP = isothermal period; TSP = temperature shifting period; STGP = stable temperature gradient period. Arrows indicate period boundaries.

2nd stable temperature gradient period—same conditions as that of 1st STGP continued for about 1 hour.

2nd temperature shifting period—desired temperature gradient and range were formed.

3rd stable temperature gradient period—“10°C gradient” and the desired temperature range continued during this period.

3rd temperature shifting period—temperature range was shifted to another desired range leaving “10°C gradient.”

4th stable temperature gradient period—desired conditions continued during this period.

In temperature selection experiments, six sets of observations were made to evaluate response to a thermal gradient. The position of each fish and water temperature in the aquarium were recorded at 3-minute intervals throughout the experimental period, but only data obtained from each stable temperature gradient period were used to determine the thermal behavioral response of fish.

The average temperature and its standard deviation in each zone during the stable temperature gradient periods were calculated from 20 temperatures and stored in the computer.

The role of temperature as the main factor controlling the distribution of fish in an aquarium was recognized through the observation of changes of the temperature gradient and shifts in fish distribution. Fish distributions in the aquarium were shown as percentage frequency distribution of the observational zone occupied by fish during a unit (5 fish \times 20 times = 100 observations). These frequency distributions were then compared with the temperature gradient to determine the temperature preferred by the fish. After the experiment, body length and weight of each fish were measured.

Results and discussion

Sizes of fish used in this study are shown in Table 1. During the isothermal period, fish distributions were not consistently symmetrical (Fig. 1). This suggests that the conditions in the aquarium were not homogeneous for all fish groups. As mentioned earlier, three pairs of 40-watt fluorescent lamps were suspended over the center of the aquarium and the light intensity at the water surface was 60-80 lux. It has been reported that rainbow trout, *Salmo gairdneri*, at 220 and 2200 lux displayed a definite affinity for the upper part of the tank during the first 4 months of life (Kwain and McCauley 1978). Although experiments on the effect of illumination on the distribution of horse mackerel in isothermal conditions were not carried out in the present study, no remarkable change in distribution of fish was observed. Based on these results, the overhead illumination was used throughout the experiment without special consideration.

A summary of observations on preferred temperature of horse mackerel at three acclimation temperatures (20, 25, and 28°C) is shown in Table 1. The maximum range of water temperature occupied by fish acclimated to 20°C at the stable temperature gradient period (keeping water temperature at 15-35°C) was 17-30°C; in the case of the 25°C acclimation temperature, the maximum range was 20-31°C; and in the case of 28°C, it was 18-31°C. From these results, the temperature range occupied by immature horse mackerel was thought to be fairly wide. This fact agrees well with the wide distribution of horse mackerel in natural habitats.

Temperature appeared to be the dominant factor influencing fish distributions in a vertical temperature gradient aquarium, since the position of the mode of distributions moved in accord with the location of preferred temperature (Fig. 5).

Usually, preferred temperature has been defined as the temperature most frequently occupied when fish are held in temperature gradient conditions for a long time. On the other hand, Ingersoll

Table 1
Summary of observations on the temperature preferred by horse mackerel at three acclimation temperatures.

Experiment no. (Group no.)	Acclimation temp. (°C)	Body length (cm)		Period no.	Temp. range in aquarium (°C)	Temp. occupied by fish (°C)		
		Mean	SD			Range	Mean	SD
I (1)	20	20.8	1.8	1st	15.6-34.9	18.7-24.8	23.0	1.5
				2nd	15.6-35.0	20.8-26.9	23.6	1.1
				3rd	18.6-27.6	19.9-23.0	22.4	0.8
				4th	15.3-24.7	19.4-22.4	21.3	0.8
II (2)	20	20.4	1.5	1st	15.1-34.7	17.1-27.0	22.9	1.8
				2nd	15.1-34.7	18.6-24.0	23.3	1.2
				3rd	18.3-28.2	21.0-24.1	22.9	0.8
				4th	15.7-24.3	19.5-23.1	21.1	0.8
III (1)	25	19.5	1.0	1st	15.0-35.2	20.9-31.3	25.6	1.5
				2nd	15.1-35.2	20.9-29.4	25.4	1.4
				3rd	18.2-27.9	19.7-26.7	24.5	1.6
				4th	18.2-28.0	19.7-26.7	24.9	1.0
IV (2)	25	20.4	0.7	1st	15.2-34.9	21.0-29.2	25.2	1.7
				2nd	15.1-34.9	23.5-29.2	25.5	1.3
				3rd	18.7-27.5	22.4-26.6	25.2	0.9
				4th	22.5-31.9	23.4-27.3	25.6	1.1
V (1)	28	20.8	1.0	1st	15.1-35.0	21.0-27.0	25.5	1.4
				2nd	15.2-35.0	18.8-29.3	25.3	1.5
				3rd	18.2-27.9	21.1-27.0	24.9	1.3
				4th	18.2-28.0	21.0-27.0	24.8	1.2
VI (2)	28	23.2	1.6	1st	15.3-35.0	18.5-31.1	24.4	1.8
				2nd	15.3-35.0	21.1-28.9	24.8	1.3
				3rd	23.2-32.7	24.3-27.9	25.0	0.8
				4th	23.1-32.7	24.3-27.0	24.8	0.7

and Claussen (1984) used two methods to determine preferred temperature of laboratory animals: the acute thermal preferendum (obtained within 2 hours or less after animals have been placed in a gradient) and the final temperature preferendum (obtained after 24-96 hours in a gradient). The preferred temperature was obtained within 1 hour in our study. Therefore the result is considered to show the acute thermal preferendum rather than the final temperature preferendum.

The relationship between acclimation temperature and mean preferred temperature (mean of occupied temperatures in Table 1) is shown in Figure 6. Immature horse mackerel acclimated to 14, 20, or 25°C preferred temperatures higher than the acclimation temperature, while fish acclimated to 26 or 28°C selected temperatures lower than the acclimation temperature. The data were best fitted by the equation

$$Tp = 1.33TA - 0.03TA^2 + 7.37 \quad (R^2 = 0.82),$$

where Tp is preferred temperature, and TA is acclimation temperature. The acute thermal preferendum, the point where $Tp = TA$, was 24.9°C.

The range of all preferred values obtained from three acclimation temperatures was wide (17-31°C) and included the range of temperatures found in coastal area habitats (15-26°C) and fishing grounds for the immature fish (16-25°C) (Yamada 1969).

Acknowledgments

We would like to express appreciation to the Ministry of International Trade and Industry for funding and use of laboratory facilities. We also would like to thank Miss K. Matsumoto for her assistance in preparation of the manuscript.

Citations

- Fukataki, H., and S. Tsuchida.**
1986. Structure and efficiency of the new vertical temperature gradient device. Spec. rep. 1, p. 47-72. Mar. Ecol. Res. Inst., Chiba, Japan.
- Kwain, W., and R.W. McCauley.**
1978. Effects of age and overhead illumination on temperatures preferred by underyearling rainbow trout, *Salmo gairdneri*, in a vertical temperature gradient. J. Fish. Res. Board Can. 35:1430-1433.
- Ingersoll, C.G., and D.L. Claussen.**
1984. Temperature selection and critical thermal maxima of the fantail darter, *Etheostoma flabellare*, and johnny darter, *E. nigrum*, related to habitat and season. Environ. Biol. Fish. 11(2):131-138.
- Yamada, T.**
1969. On the distribution and the fishing ground of horse mackerel in Japan Sea. Bull. Fac. Fish. Nagasaki Univ. (28)111-130.

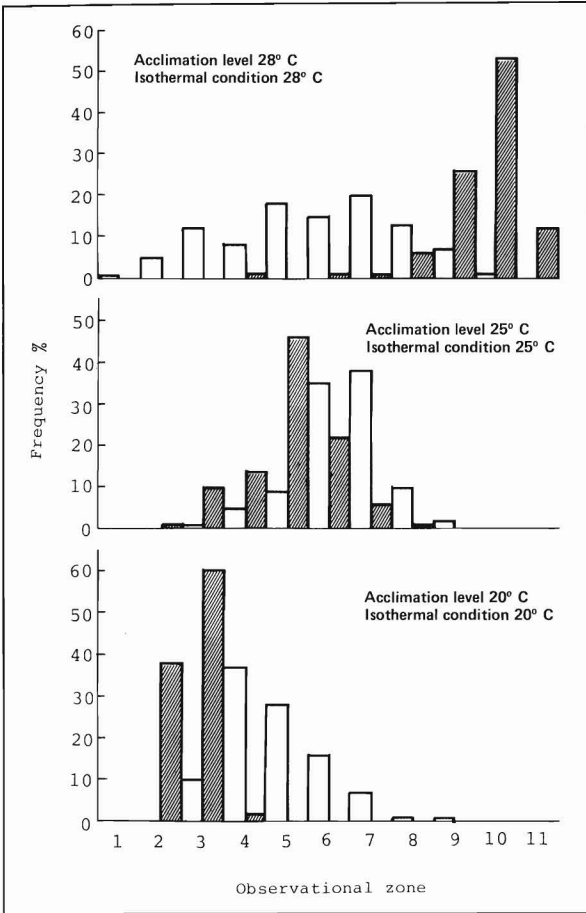

Figure 4

Percentage frequency-distribution of zone occupied by fish in the isothermal period. Unshaded bars are group 1 and shaded bars are group 2.

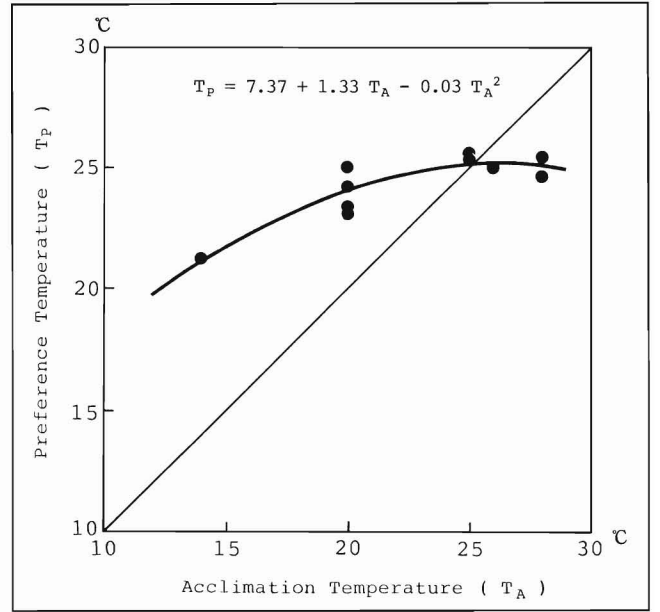

Figure 6

Relation of preference temperature to acclimation temperature in horse mackerel.

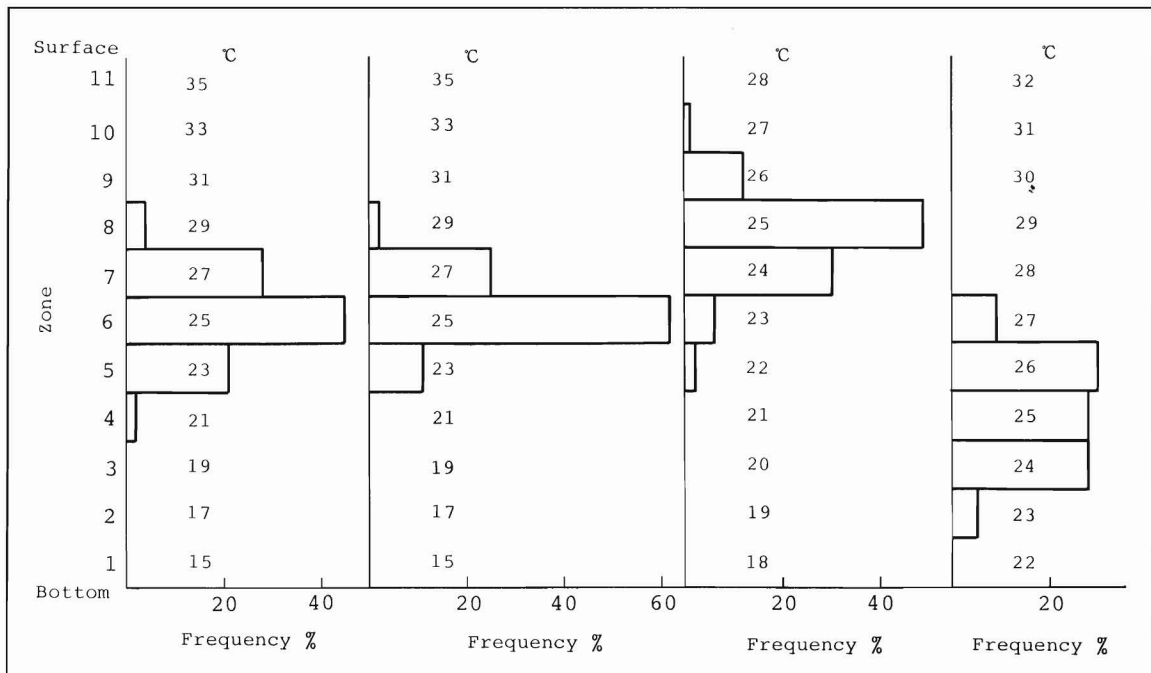

Figure 5

Distribution of horse mackerel corresponding to the temperature shift in aquarium.

Effects of environment on seedlings of the king crab, *Paralithodes camtschaticus*

TAKASHI NAKANISHI

Japan Sea Regional Fisheries Research Laboratory
5939-22, 1 Suido-cho,
Niigata, 951 Japan

ABSTRACT

In order to determine optimum environmental conditions for the mass-cultivation of eggs, the effects of temperature, hypoxia, and salinity on the survival rate, growth, and respiration of king crab larvae and postlarvae were studied. Optimum temperature from fertilization to the zoea egg stage is 3-8°C, and 3°C from this stage to hatching. The optimum temperature for mass-cultivation of larvae and postlarvae is 8°C. The optimum condition of oxygen saturation is more than 80%, and of salinity is 26.8-40.2.

The king crab (*Paralithodes camtschaticus*), Hanasaki crab (*Paralithodes brevipes*), horsehair crab (*Erimacrus isenbeckii*), and snow crab (*Chionoecetes opilio*) are the main species of coldwater crabs for which mass-cultivation of larvae and postlarvae is being studied in Japan. The king crab is one of the most important fisheries in Japan, and studies of techniques of cultivating larvae and propagation have been conducted since 1940 (Kaai 1940, Sato 1958, Kurata 1959, Nakanishi 1976, Omi 1980, Nakanishi and Naryu 1981). The snow crab is also one of the most important fisheries in Japan, and there have been several reports on the fisheries and resources (Ogata 1974, Kon 1980). However, studies on rearing of larvae and propagation of snow crab and other coldwater crabs have been conducted mainly since 1970. Such mass-cultivation is being conducted at Marine Cultivation Centers under prefectural management and with the cooperation of the Japan Sea Farming Association. At present, the numbers of seedlings of king crab and Hanasaki crab exceed 200,000, and there are about 1,000 seedlings of snow crab.

When larvae and postlarvae are cultured, it is important to know the effects of the environment. One of the most important environmental variables affecting marine organisms, especially those living in the cold sea, is temperature. In culturing the larvae of coldwater crabs, it is necessary to maintain the ambient seawater at a low temperature (8°C or lower). But in order to culture these larvae for a rapid growth rate and at low cost, it would appear advantageous to culture them in warm water. However, there is little information about temperature effects on the success of mass-cultivation of crab larvae and postlarvae. Thus, this report mainly concerns the effects of water temperature.

Life history

Eggs adhere to abdominal pleopods of king crabs where they are brooded for about 300 days until they hatch. There are four planktonic zoeal stages. After approximately 30 days at 8°C, zoeae molt to glaucothoe that are able to swim but whose morphology is crab-like. The glaucothoe stage molts to become a young, bottom-dwelling crab that cannot swim. In this discussion, the egg stage is abbreviated as "E" (e.g., the egg stage at 100 days after spawning is shown as E-100), the zoeal stage as "Z," the glaucothoe stage as "G," and the young crab stage as "C."

The change in size from egg stage (the embryo) to the young crab stage is indicated by wet weight (Fig. 1-A). It increased exponentially with time (days). The regression line was bent at C-3, and the gradient of the weight declined. The king crab molts more frequently, but the growth rate is slower than that of the snow crab. At Z-4, G, and C-1, there were large morphological and ecological changes, but the dry weight, wet weight, and carapace length at Z-4, G, and C-1 were nearly the same (Nakanishi et al. 1974); in other words, there may be no growth during these stages.

Oxygen consumption also increased exponentially with time, and the regression line was bent at C-3 (Fig. 1-B). The oxygen consumption at E-300, Z-1, Z-2, G, C-1, and C-2 was under the regression line.

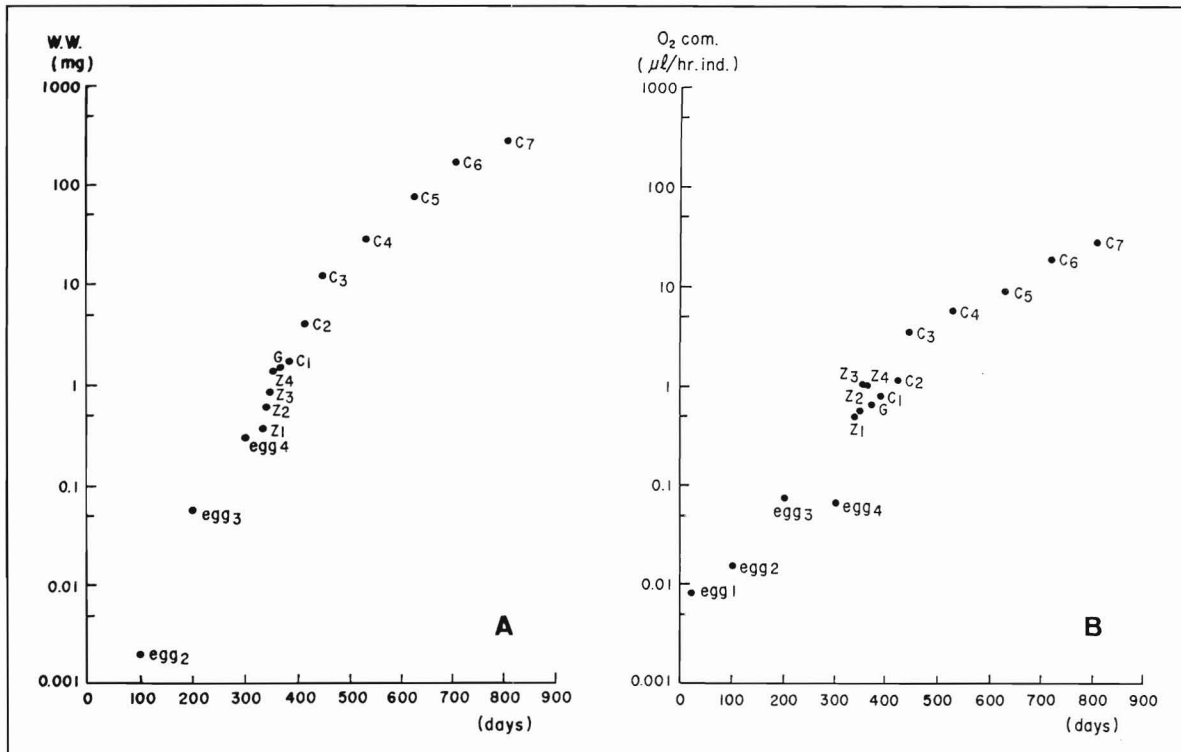

Figure 1

(A) Relationship between wet weight (WW, mg) and the term (days) at 3°C at egg stage and at 8°C at larval stage, and (B) relationship between oxygen consumption ($\mu\text{L}/\text{h}$ per individual) and the term (days) at 8°C.

Egg stage

The effect of water temperature on the survival and development rate at E was studied by cultivating egg-bearing females at approximately 3°C and 8°C in fiberglass flow-through (1 L/min.) tanks with a sand filter. Frozen squid, shrimp, and sardines were supplied for food. The experiment started with four crabs at 3°C and with three crabs at 8°C.

Egg clutch volumes at 8°C decreased rapidly from E-40 and were under 10% at E-70, while egg clutch volumes at 3°C decreased gradually, and were 10-80% when the larvae hatched (Fig. 2-A). The yolk volume at 8°C decreased rapidly from E-120, while that at 3°C decreased slowly from E-150 (Fig. 2-B). The egg-bearing females mated in the laboratory were cultured at 3°C, and the developmental stage of their eggs (Fig. 2-c-d) was regarded as a standard egg development in order to compare with the developmental stages of the eggs between 8°C and 3°C. The developmental stages of eggs at 3°C were the same as the standard. But those at 8°C were faster than the standard, and there were many fluctuations in the morphological development. The egg development of E-170 at 8°C was the same as that of E-270, i.e., E-300 at 3°C (Fig. 2-C).

Survival rate

In order to know the effects of water temperature on development and survival rate at the egg stage, eggs removed from the females' pleopods at E-23, E-57, E-166, and E-258 were cultured at -1.8, 3, 8, 13, and 18°C (Fig. 3). Culturing was done in a bacteria-free petri dish with 30 mL seawater for 5 weeks. At E-23 and E-57,

the survival rate at 5 weeks was 100% at -1.8, 3, and 8°C, 20-70% at 13°C, and 20-30% at 18°C. At E-166, the survival rate at 5 weeks was 100% at -1.8, 3, 8, and 13°C, and 90% at 18°C. At E-258, the survival rate decreased with increasing water temperature. Fifty percent of the eggs died 4 weeks later at 8°C, 3 weeks later at 13°C, and 2 weeks later at 18°C.

Egg development

Comparisons of egg development between experimental and standard groups are discussed in the same way as reported previously for long-term cultivation of egg-bearing females (Fig. 4). Growth rate increased with the increase in water temperature, but at E-23 the growth rate at 13°C was higher than that at 18°C. The size of embryos cultured at higher temperatures at E-23, E-57, and E-166 was smaller than embryos cultured at 3°C. At E-258, there was no morphological change even when the water temperature increased, and many larvae hatched out with the increase in water temperature. However, the survival rate at the larval stage was not satisfactory.

Hatching rate

The effect of water temperature on the hatching rate of eggs was studied. Eggs were removed from females' pleopods at 4 and 18 days before the larvae would have hatched normally at 3°C. These eggs were cultured at -1.8, 3, 8, 13, and 18°C in bacteria-free petri dishes with 30 mL seawater for 6 days, and the hatching rate of eggs at each water-temperature condition was observed daily.

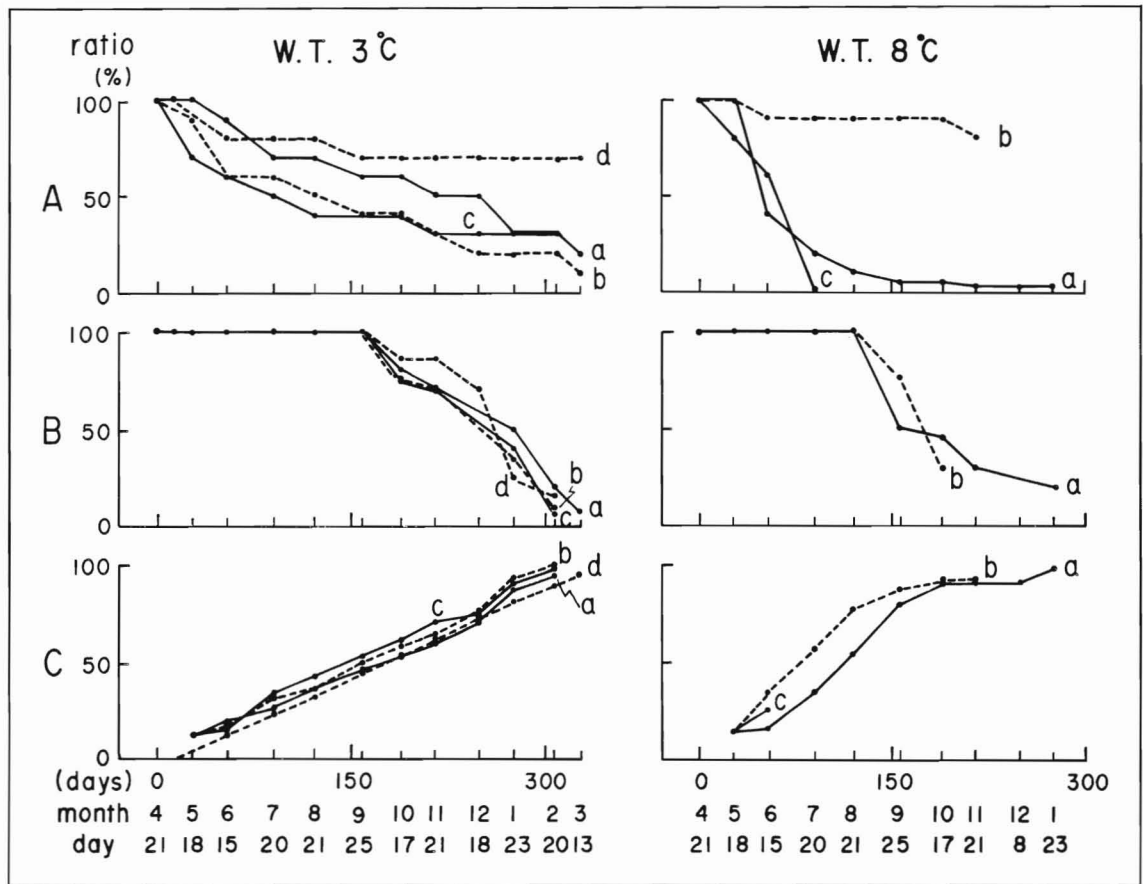

Figure 2

(A) Egg clutch volumes (100% at the start of experiment), (B) ratio of volumes of yolk (by observation of fresh samples), and (C) relationship between egg development at each experimental condition and the standard (c-d) at water temperatures (WT) of 3° and 8°C.

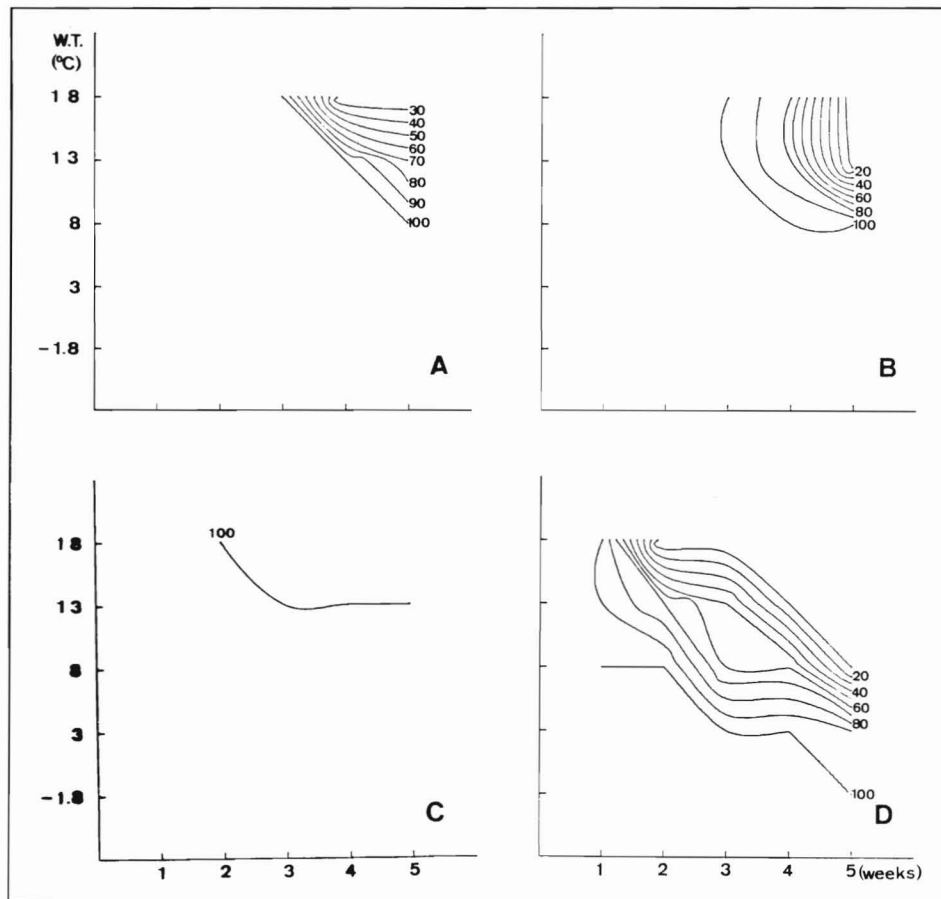

Figure 3

Effect of water temperature on survival rate of eggs. Days post-spawning: (A) 23 days, (B) 57 days, (C) 166 days, and (D) 258 days.

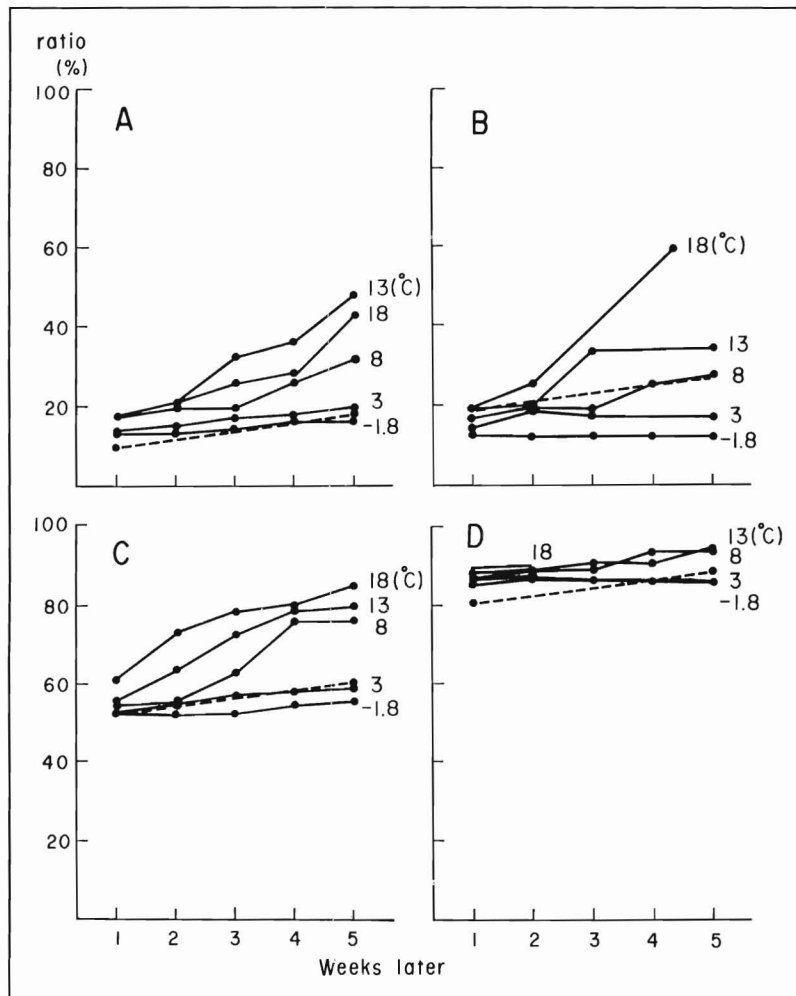

Figure 4

Effect of water temperature on egg development compared with standard development (dotted line). Days post-spawning: (A) 23 days, (B) 57 days, (C) 166 days, (D) 258 days.

In the experiment using eggs removed 18 days before normal hatching, there was no hatch at -1.8 and 3°C for 6 days, but larvae hatched 4-5 days later at 8°C , 3 days later at 13°C , and 2 days later at 18°C (Fig. 5-A). In the experiment using eggs removed 4 days before normal hatching, larvae hatched 3 days later at 8°C and 1-2 days later at 13 and 18°C (Fig. 5-b). Raising the temperature was an easy method of ensuring equal growth rate. However, the survival rate of postlarvae was low; therefore it was dangerous for eggs to be exposed to warmer temperatures just before hatching.

Survival rate in the air

The survival rate of the eggs at E-250 in the air (100% humidity) was conducted at -1 , 3 , 8 , and 13°C (Fig. 6). They survived for over 10 days at -1 and 3°C , but 50% died 32 hours later at 8°C .

Egg-bearing females cultured at $3-8^{\circ}\text{C}$

These data suggest that the temperature from 3 to 8°C represents an optimum temperature for the development to the zoea egg stage (about 200 days after spawning at 3°C), and 3°C represents an optimum temperature after the zoea egg stage. So egg-bearing females were cultured at 8°C and at 6°C from E-120 to the zoea egg stage, and from this stage, the rearing-water temperature was decreased gradually to 3°C . Egg-bearing females were cultured at 3°C until the larvae hatched (Fig. 7). The egg clutch volume was 80% when the larvae hatched, and the survival rate of postlarvae was 20-30%. This rate was similar to survival rates of postlarvae hatched from the egg-bearing females cultured at 3°C . This method of controlling the temperature was more energy-efficient than keeping it at 3°C in summer, and hatching could be advanced by 2 months. Therefore, the same tank could be used twice or three times to culture larvae. The first mass-cultivation was conducted with egg-bearing females cultured at $3-6-8^{\circ}\text{C}$. The second group of larvae hatched from the egg-bearing females cultured at 3°C or caught in the field.

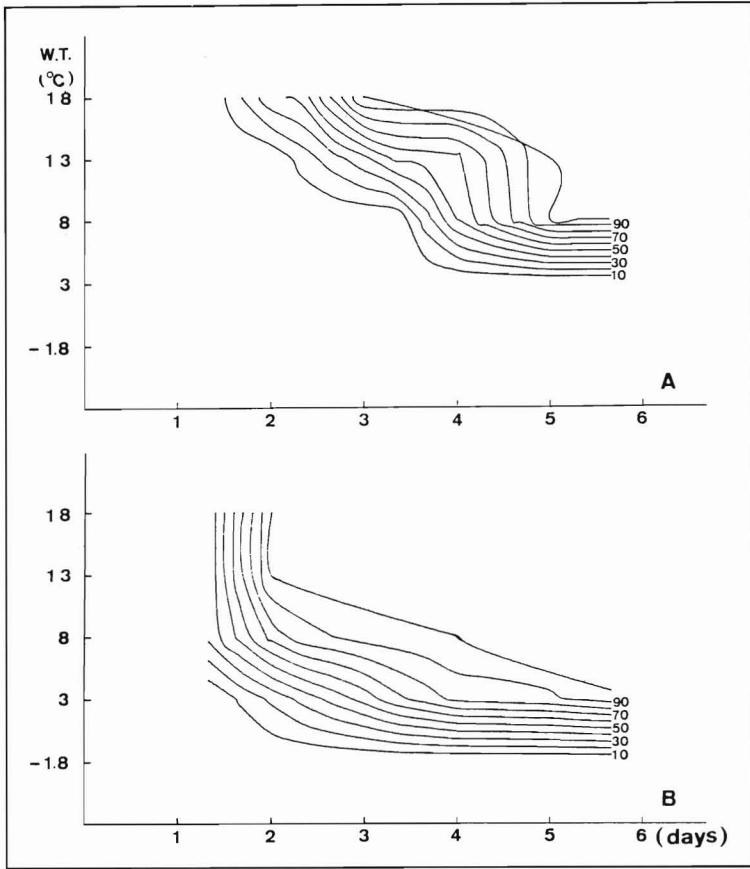

Figure 5
Effect of water temperature on the hatching rate of eggs, 13 to 19 March. (A) Normal hatching at 31 March and 13-19 March; (B) normal hatching at 17 March.

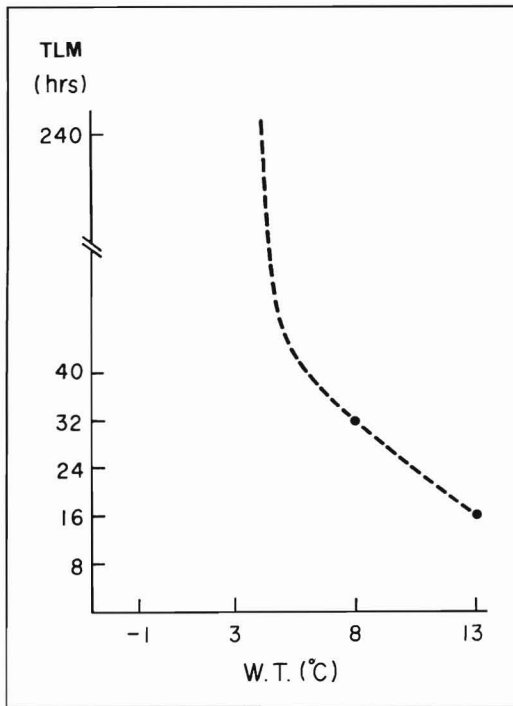

Figure 6
Effect of exposure to air (100% humidity) on the survival rate of eggs at 250 days after spawning.

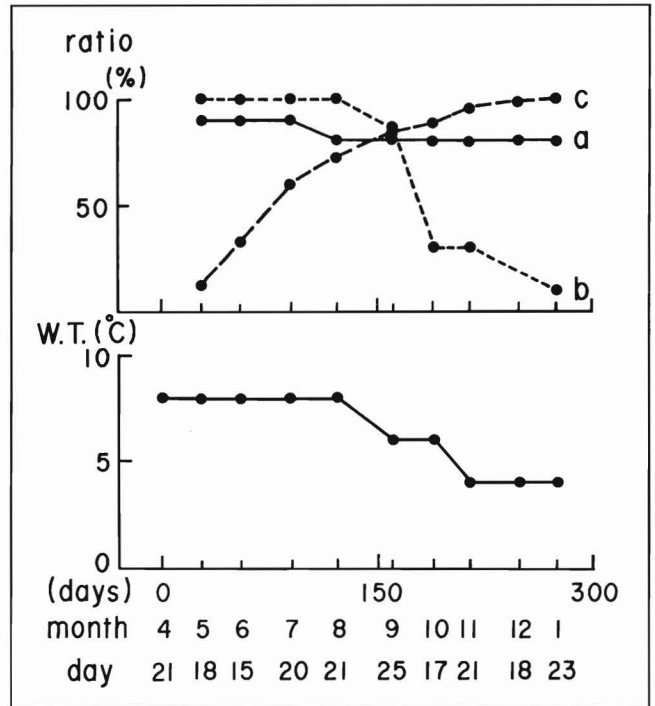

Figure 7
Egg development reared at 8-6-3°C; (a) egg clutch volumes, (b) volumes of yolk, compared with (c) standard development.

Larvae and postlarvae

Survival and growth rate

The experiment to determine the effect of water temperature on the survival and growth rate was conducted in polyethylene tanks (47×30×20 cm depth) with 5 liters seawater at -1.8, 3, 8, 13, and 18°C. Four tanks were used for each temperature: two tanks with 20 zoeae and the other two tanks with 40 zoeae. When 50% of the zoea developed to the next stage, the former stage was regarded as terminated.

The survival rates at Z and G at 8 and 13°C were higher than those at 3 and 18°C (Fig. 8). The glaucothoe molted to C-1 at 8 and 13°C, but all glaucothoe at 3 and 18°C died before molting to C-1. The survival rate from Z-1 to C-1 was 25% at 8°C and 5% at 13°C. It took 40 days from Z-1 to Z-2 at -1.8°C, and all zoeae died before molting to Z-3.

The relationship between the time (days) of each stage and water temperature could be expressed by the formula $\log y = b \log x + a$ (y = time (days) and x = water temperature (°C)) with a high correlation (Fig. 9). The variable b was roughly equal to 1; therefore, these regression formulas were regarded as "the total integrated temperature" ($xy = C$) which was approximately 350°C days at Z.

Carapace length at young crab stage

The relationship between water temperature and growth rate of young king crabs in some reports (Kurata 1961, Nakanishi et al. 1974, Omi 1976 and 1977 in Omi 1980) gave the formula $\log y = a + bx$ (y = carapace length (mm) and x = stage) with a high correlation (Fig. 10). I replaced these regression formulas with the highest value of b (in other words, with the highest growth rate during each stage) (Table 1). The environmental conditions pro-

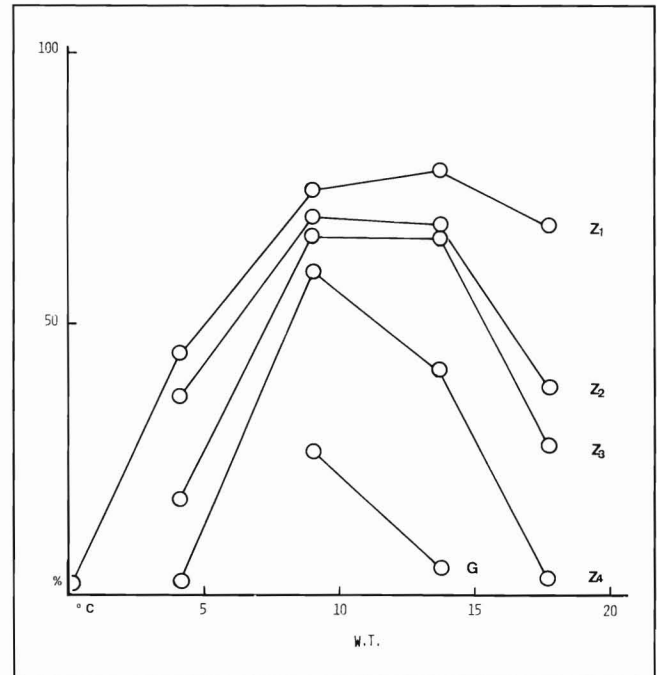

Figure 8

Effect of water temperature on survival rate (%) of larvae.

ducing these results were shown from the highest value of b as follows: more than C-4 at 8-9°C > less than C-5 at 8-9°C > more than C-4 at 3°C. The growth rate was higher for higher water temperature and older crabs.

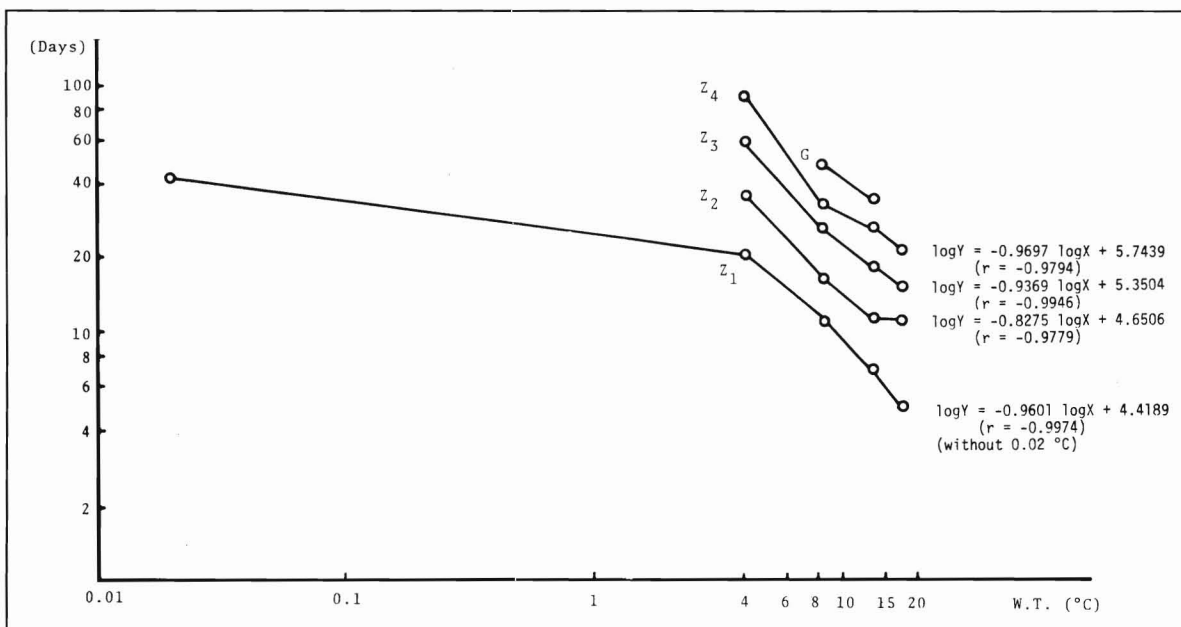

Figure 9

Relationship between water temperature and growth rate (days) of larvae.

Oxygen consumption

Oxygen consumption at E-20, E-100, E-200, and E-300, Z, G, and C-1 was measured at 3, 8, and 13°C (Fig. 11). The specimens were placed in syringes held in a temperature-controlled water bath. Two water samples (about 0.2 mL each) were taken from the syringe at zero time, and two more samples from 30 minutes to 4 hours later depending on the temperature and the developmental stage. Oxygen concentration was calculated from oxygen pressure measured by an oxygen meter (Instrumentation Laboratory Co.). Five syringes were used, each containing 20-100 eggs or a single larva.

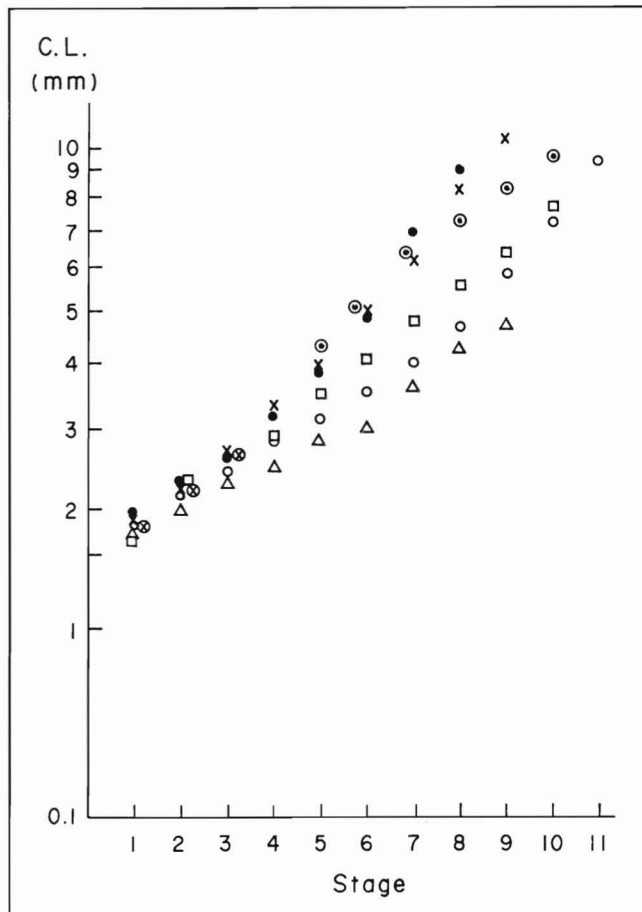

Figure 10

Relationship between stage and carapace length (CL mm) of young king crab. ● (water temp. 8°C); ○ (water temp. 3°C); ○·x (Omi 1980); Δ·□ (Kurata 1961).

From E-20, E-100, and E-200, oxygen consumption ($\dot{V}O_2$) increased, but $\dot{V}O_2$ at E-200 and E-300 was the same. Oxygen consumption at 13°C was the highest, the lowest was at 3°C, and the intermediate at 8°C. Oxygen consumption at Z-1 was about ten times that at E, and from Z-1 to C-1 at 3°C was almost the same. Oxygen consumption at Z-3 peaked at 8°C and then decreased from this stage.

Food consumption

Experiments to determine the effect of water temperature on the number of brine shrimp nauplii eaten was conducted at -1.8, 3, 8, 13, and 18°C from Z-1 to C-1 (Fig. 12). Larvae were put into a petri dish with 100 brine shrimp nauplii in 30 mL of seawater, and the number eaten was counted under a stereoscopic microscope 24 hours later. The number eaten at Z gradually increased with the developmental stage and the increase in water temperature, but its increase at Z-4 stopped at 8°C. The number eaten decreased sharply at G and C-1. Perhaps brine shrimp are not a good prey for postlarvae, since in other experiments with five kinds of food at G, no food could be found in their stomachs. Perhaps the G does not feed.

Movement and activity at young crab stage

When seedlings are released into the field, they are exposed to conditions of rapidly changing temperature. Therefore, the effect of water temperature on the movement at C was studied in an experimental tank (180×40×40 cm depth) that had six partition walls inside the tank to make a wide water-temperature gradient. Warm (16.5°C) and cold (3°C) seawater was put into each corner of this tank (Fig. 13-B). Young crabs at C-4 or C-5 cultured at 3, 8, and 13°C were released into the tank at 3, 8, and 13°C, respectively. The movements of these crabs were observed for 15 minutes at intervals of 30 seconds. In each experimental condition, five crabs were used.

The young crabs that were cultured at 3°C and released at 13°C moved the longest distance 15 minutes after their release (Table 2A). Crabs cultured at 3°C and released at 8°C moved an intermediate distance. The difference between distances moved at 3 and 8°C was large. Young crabs cultured at 13°C and released at 3°C could not move, and seemed paralyzed. Those released at 8 or 13°C moved actively. They had no tendency to move to the same water temperature where they had been cultured, but they distributed themselves throughout locations of various temperatures (Table 2B).

Table 1
Relationship between stage and carapace length of each experiment [$\log (CL=a+b(STAGE))$]. Asterisks indicate $p=0.05$.

No.	Experiment	Stage	(°C)	1	2	3	4	5	6	7	8	9	10	b
1		>=C5	8.0	.	○	*	*	*	*	*	*	*	*	0.1236
2	Omi 1980	>=C5	9.2	○	.	*	○	*	*	*	*	*	*	0.1054
3	Omi 1980	C8-12	9.2	*	*	.	○	*	*	*	*	*	*	0.0991
4	Nakanishi et al. 1974	C1-3	11.4	*	*	○	.	*	*	*	*	*	*	0.0950
5	Omi 1980	=<C4	9.2	*	*	*	*	.	*	*	*	*	*	0.0879
6		=<C4	8.0	*	*	*	*	*	.	○	○	*	*	0.0782
7	Kurata 1961			*	*	*	*	*	*	○	○	*	*	0.0778
8		C5-10	3.0	*	*	*	*	*	○	○	.	*	*	0.0733
9	Omi 1980	<C8	9.0	*	*	*	*	*	*	*	*	.	*	0.0570
10	Kurata 1961		13-17	*	*	*	*	*	*	*	*	*	.	0.0523

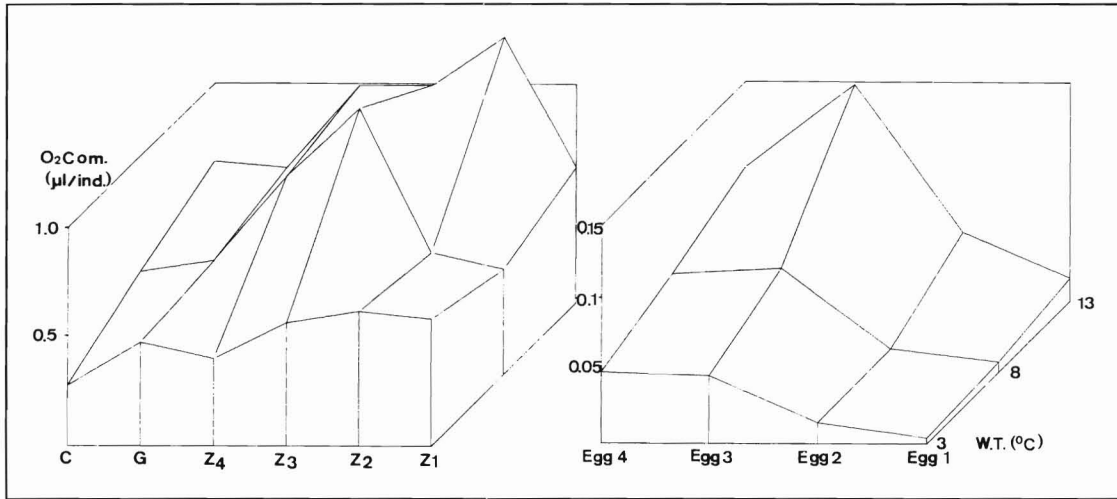

Figure 11

Effect of water temperature on oxygen consumption ($\mu\text{L/h}$ per individual) at egg, larval, and postlarval stage. Days post-spawning: Egg 1, 20 days; Egg 2, 100 days; Egg 3, 200 days; and Egg 4, 300 days.

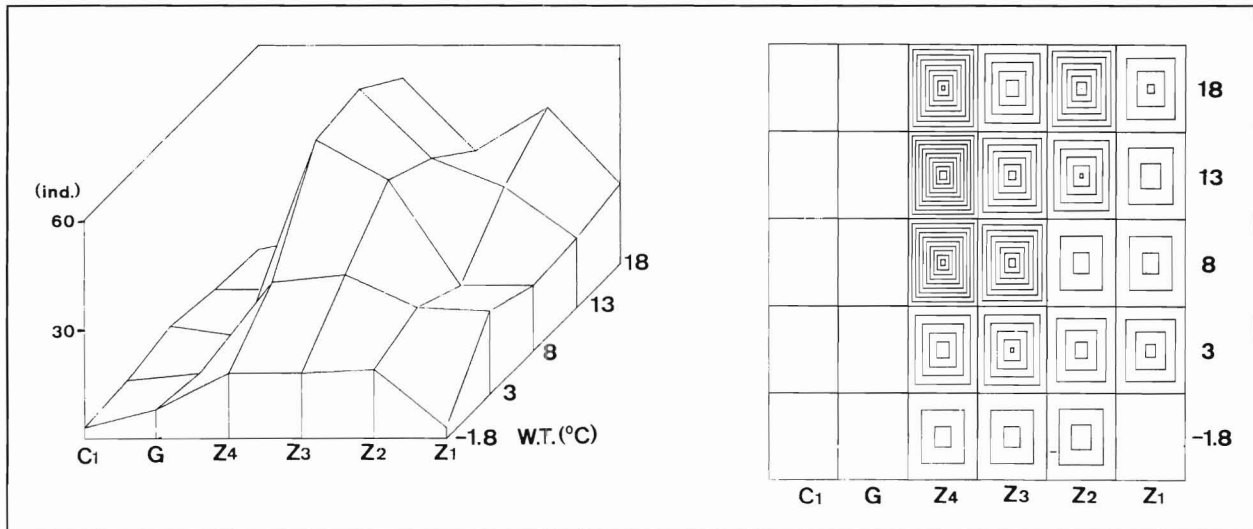

Figure 12

Effect of water temperature on the numbers of brine shrimp nauplii (individuals) eaten by larvae and postlarvae. (Right) birds-eye view of three-dimensional graph (left); denser lines indicate high values in the upper graphs.

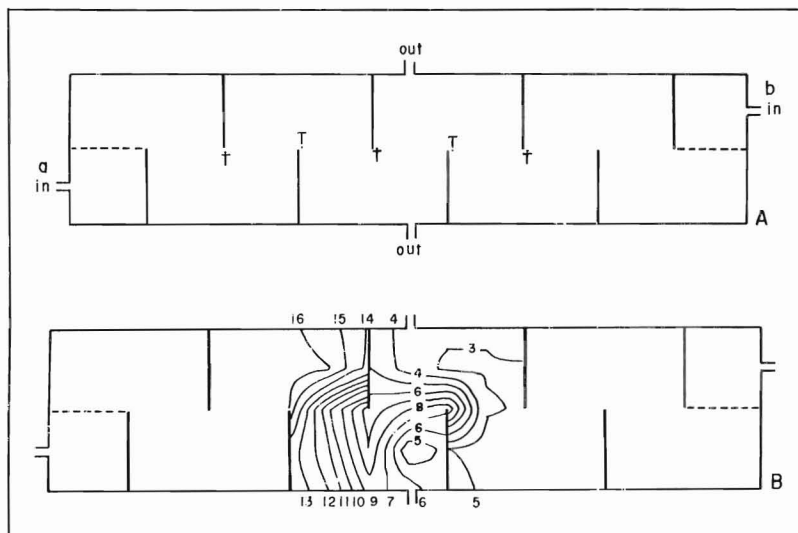

Figure 13

Apparatus to determine the effect of temperature on the movements of young crab. (Aa) warm seawater (16.5°C) flow; (Ab) cold seawater (3°C) flow; (T) thermometer; (B) one example of water temperature in the experimental tank.

Table 2A
Mean and standard deviation (SD) of the total movement (cm) of young king crab for 15 minutes in an experimental tank.

Water temperature (young crab put in)	Rearing water temperature before experiment								
	3°C			8°C			13°C		
	\bar{x}	SD	n	\bar{x}	SD	n	\bar{x}	SD	n
3°C	29.3	13.00	5	16.5	7.68	5	3.7	3.32	5
8°C	30.2	24.03	5	43.8	26.37	5	30.2	24.03	5
13°C	31.7	16.48	4	63.5	30.01	4	36.3	18.57	4

Table 2B
Water temperature (°C) occupied by young king crabs 15 minutes after release in a temperature gradient.

Water temperature (young crab released)	Rearing water temperature before experiment					
	3°C		8°C		13°C	
	\bar{x}	SD	\bar{x}	SD	\bar{x}	SD
3°C	3.8	3.5	3.9	3.6	3.0	3.0
	4.0	4.0	4.0	3.1	3.0	3.0
	4.0		3.0			
8°C	9.8	16.3	7.6	4.8	9.0	9.0
	8.4	8.7	15.3	7.5	8.4	5.0
	8.1		2.7		4.5	
13°C	9.2	11.5	14.5	16.5	12.9	7.1
	13.9	14.0	15.0	16.5	7.9	15.5
	12.0		16.1			

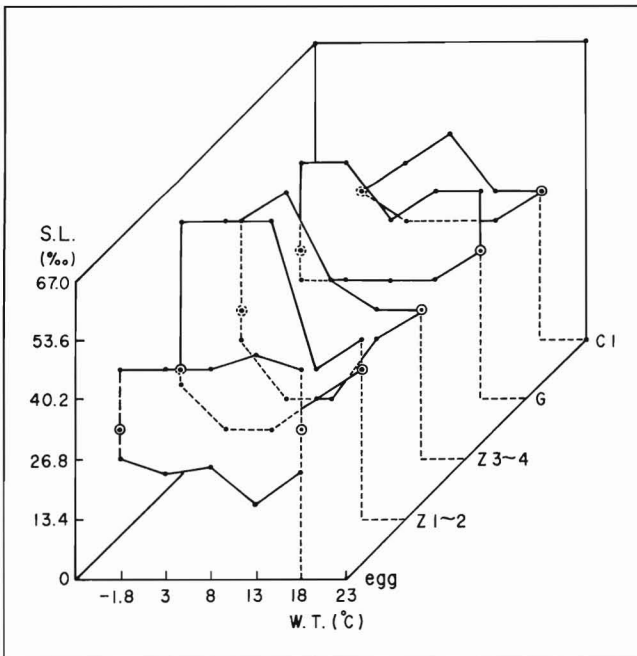

Figure 14

Effect of salinity (SL) and water temperature on the survival rate of egg, larval, and postlarval stages.

Effect of salinity

The effect of water temperature and salinity on survival rate was studied. Eggs that would hatch in about 30 days, Z-1 and Z-2, Z-3 and Z-4, G and C-1, were used in this experiment (Fig. 14). Ten eggs or ten larvae were placed in a 1-liter beaker, and the survival rate after 24 and 48 hours observed. The experimental temperatures were $-1.8, 3, 8, 13, 18,$ and 23°C , and at 11 salinity conditions ranging from 0 to 67, at intervals of 6.7. There were $6 \times 11 = 66$ experiments with paired observations. In Figure 14, the area representing the 100% survival rate at 48 hours was shown from the largest area as follows: Z-1 and Z-2 $>$ Z-3 and Z-4 $>$ G = eggs (about 30 days before hatching) $>$ C-1. The tolerance to the change of water temperature and salinity is the highest at Z, and it is the lowest at C. The thermal tolerance in 33.5 seawater (approximately the same salinity as natural seawater) was between -1.8° and 18°C . The eggs, larvae, and postlarvae have a large short-term thermal tolerance.

Effect of hypoxia on oxygen consumption

The same methods used in the experiment on oxygen consumption ($\dot{V}\text{O}_2$) were used to study the effect of hypoxia on $\dot{V}\text{O}_2$ at 3, 8, and 13°C (Fig. 15). Different degrees of oxygen saturation (PO_2) were obtained by passing nitrogen gas through seawater. At 3°C , value for PO_2 where $\dot{V}\text{O}_2$ was maintained at a level similar to PO_2 of 90-100% was the lowest at E-100 and the highest at G. The normal rate of $\dot{V}\text{O}_2$ at lower PO_2 suggested that there might be a physiological adjustment for taking up oxygen. A homeostasis of oxygen consumption at E was observed at oxygen saturation higher than 50%, and homeostasis of oxygen consumption at Z, G, and C-1 was observed at PO_2 of 70-80%, but the gradient at C-1 was above those at Z and G. The effect of water temperature on oxygen consumption under hypoxia conditions had the same tendency except at G at 3°C .

Discussion

These results suggest that there is little negative effect of 8°C seawater on eggs until the zoea egg stage (about 200 days after spawning at 3°C), and that 8°C water increases growth rate of eggs and reduces the rearing cost (Fig. 16). However, from the zoea egg stage, a temperature of 8°C affected the survival rate, and 3°C was the optimum water temperature.

The zoeae had a large thermal tolerance, but from the viewpoint of growth rate and survival rate, 8°C was the optimum water temperature. Glaucothoe had the same characteristics. The thermal tolerance at C was smaller than that of the larvae, and the growth rate suggested that an optimum water temperature for the cultivation was 8°C . The thermal tolerance of king crab was greater than that of Hanasaki crab (Nakanishi 1981), and the optimum temperature was lower than that of snow crab (Kon 1980). It seemed that this characteristic might be one reason for the limitation of the main distribution of the king crab to more northern parts of Japan than that of the snow crab.

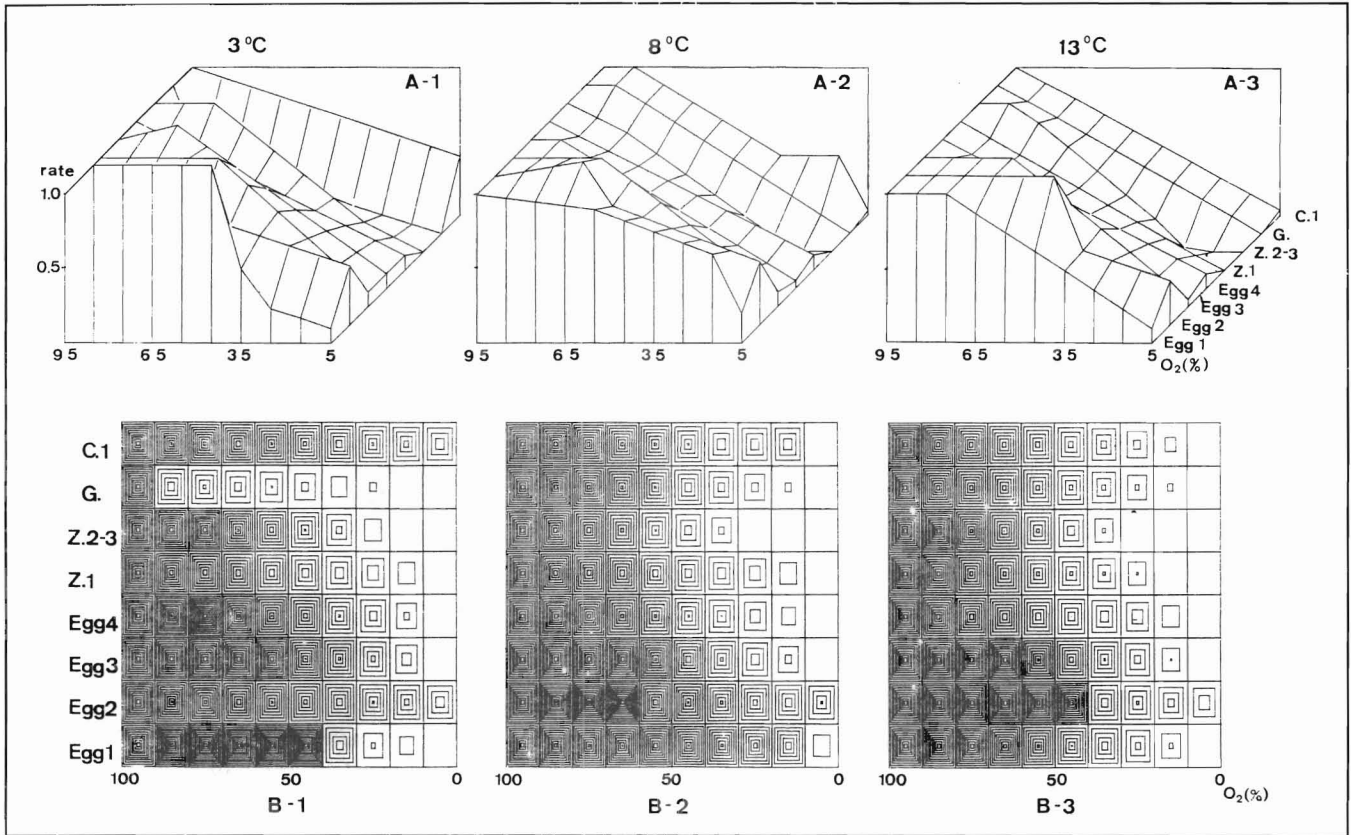

Figure 15

Effects of hypoxia on oxygen consumption at egg, larval, and postlarval stages. (Lower) birds-eye view of upper three-dimensional graphs; denser lines indicate higher values in the the upper graphs. Egg 1, 20 days; Egg 2, 100 days; Egg 3, 200 days; and Egg 4, 300 days after spawning.

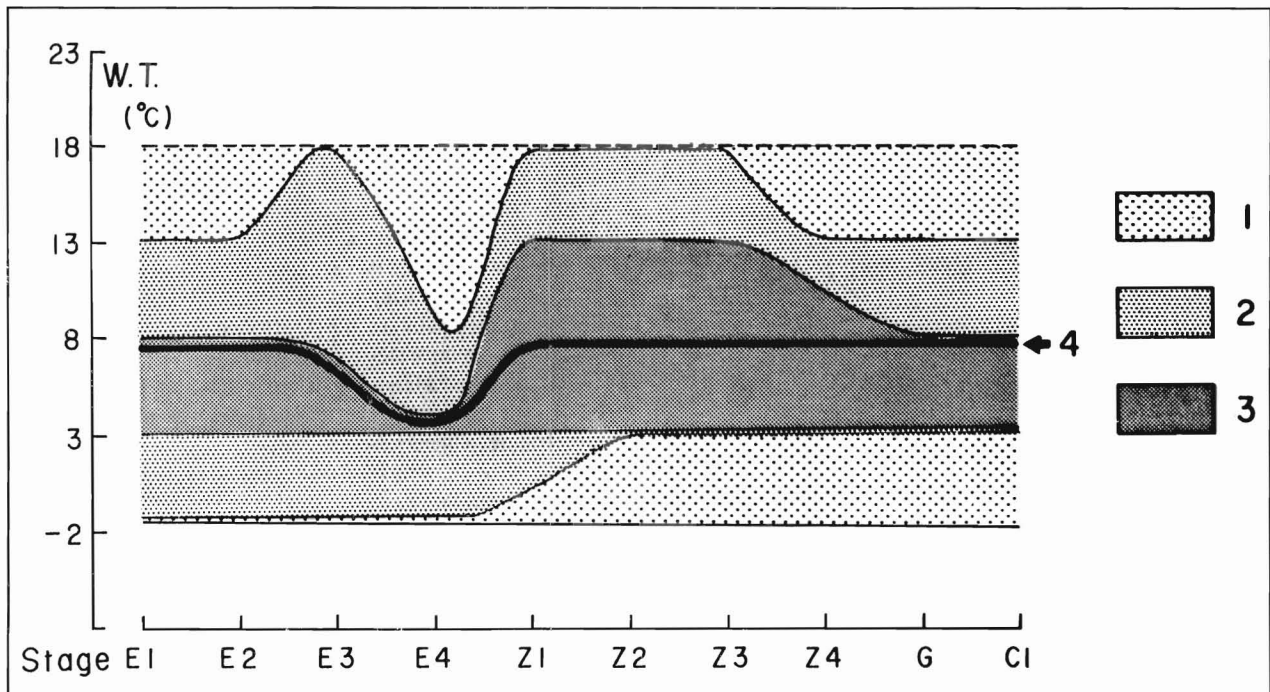

Figure 16

Optimum water temperature for egg, larval, and postlarval stages. (1) Survival rate at 48 hours is 100%; (2) survival rate at 30 days at the egg stage is 100%, and juvenile can molt to the next stage; (3) normal cultivation is possible; (4) optimum temperature for mass-cultivation.

Acknowledgment

I wish to express my thanks to Mrs. Naganuma for preparing the figures.

Citations

Kaai, T.

1940. The culture of young crab of the king crab. Hokkai-shi Junpo 469:3-4 (in Jpn.).

Kon, T.

1980. Studies on the life history of the zuwai crab, (*Chionoecetes opilio*) (O. Fabricius). Spec. Publ. Sado Mar. Biol. Stn. Niigata Univ. 2:1-64 (in Jpn., Engl. summ.).

Kurata, H.

1959. Studies on the larva and post-larva of *Paralithodes camtschatica*. 1. Rearing of the larvae with special reference to the food of the zoea. Bull. Hokkaido Reg. Fish. Res. Lab. 20:76-83 (in Jpn., Engl. summ.).

1961. Studies on the larva and post-larva of *Paralithodes camtschatica*. 4. Growth of the post-larva. J. Hokkaido Fish. Exp. Stn. 18:1-9 (in Jpn., Engl. summ.).

Nakanishi, T.

1976. Rearing larvae and post-larvae of the king crab (*Paralithodes camtschatica*). Proc. FAO Tech. Conf. on Aquaculture, Kyoto, Japan.

1981. The effect of temperature on growth, survival and oxygen consumption of larvae and post-larvae of *Paralithodes brevipes* (Decapoda; Anomura). Bull. Jpn. Sea Reg. Fish. Res. Lab. 32:49-56.

Nakanishi, T., Y. Kuwatani, and H. Kahata.

1974. The relationship between carapace length and body weight of the larva and post-larva of *Paralithodes camtschatica*. Bull. Hokkaido Reg. Fish. Res. Lab. 40:32-37 (in Jpn., Engl. summ.).

Nakanishi, T., and M. Naryu.

1981. Some aspects of large-scale rearing of larvae and post-larvae of the king crab (*Paralithodes camtschatica*). Bull. Jpn. Sea Reg. Fish. Res. Lab. 32:39-47.

Ogata, T.

1974. The studies on the resources of Zuwai crab (*Chionoecetes opilio*) in Japan Sea. Nippon-Suisansigenhogo-Kyokai Tech. Rep. 26, 66 p. (in Jpn.).

Omi, H.

1980. Report on the experiment of aquaculture of king crab, 1975-1979. Tarabagani-zousyokugi jyutu-kaihatushiken-houkoku, 64 p. (in Jpn.).

Sato, S.

1958. Studies on larval development and fishery biology of king crab, *Paralithodes camtschatica* (Tilesius). Bull. Hokkaido Reg. Fish. Res. Lab. 17:1-102 (in Jpn., Engl. summ.).

Some methods of water-flow control for mariculture

TOSHIFUMI NOMA

Aquacultural Engineering Division
National Research Institute of Fisheries Engineering
Ebidai, Hasaki-machi
Ibaraki Mz, 314-04 Japan

It was more than 20 years ago that we heard "toru gyogyo kara tsukuru gyogyo e" (from the hunting to the cultured fishing). At that time, Japan was eager to increase maricultured products such as sea algae (*Porphyra tenera*), oyster, pearl oyster, and yellowtail. Thus, techniques that would increase such production, related to environmental control, have been expected to be developed. An example is increasing seawater exchange to improve the water quality of a farming area in a bay.

Fisheries engineering must concern itself, in the short- or long-term, with the life cycle of marine organisms, from "womb to tomb." It must also be interested in favorable conditions for marine life and dispersion processes of larvae. Engineering problems can be divided as follows: responses of the animals to the physiochemical environment, dispersion control, improvement of water quality, improvement and construction of habitats, and aquacultural facilities.

This paper reviews some of the methods that can control the aquatic environment as it is related to aquaculture.

Water quality control

To rear a marine organism, the existence of seawater is inevitable; however, its mere existence is not sufficient for the life of the organism. Seawater must have a motion that results in an exchange of the seawater for food or nutritious salts, a supply of dissolved oxygen, or removal of animal wastes. Energy such as tidal force, sea current, wave, or in some cases, motor power, is needed to provide proper motion of the seawater.

Improvement of tidal inlets

In Japan, to avoid damage from storm surges, mariculture is performed in a bay well closed by topography. This can result in the deterioration of water quality because of deficiency in seawater interchange. If there is a tidal motion, a less opened basin causes a water level difference or phase difference of tidal level between the outer sea and the inner basin, due to the flow resistance of bottom and side friction of the inlet.

Interchange flow rate q between two waters is expressed by

$$q = \pm CA \sqrt{2g\Delta h} \quad (1)$$

$$C = [1.4 + 0.02 l/D^{4/3}]^{-1/2} \quad (2)$$

where A = cross-sectional area of flow, Δh = water level difference, l, D = length and depth of the inlet, and g = gravitational acceleration. Coefficient of discharge, C , depends on length and shape of the inlet. Changes in the tidal inlet may result in improvement of C . This depends on reducing the length and revising the water depth, D , of the inlet.

Interchange flow, Q_{max} , can be obtained graphically with tidal ranges of outer sea and inner basin, ξ, ξ' , surface area of inner basin, S , tidal period, T , and river flow rate, q_r (Nakamura and Hagino 1977).

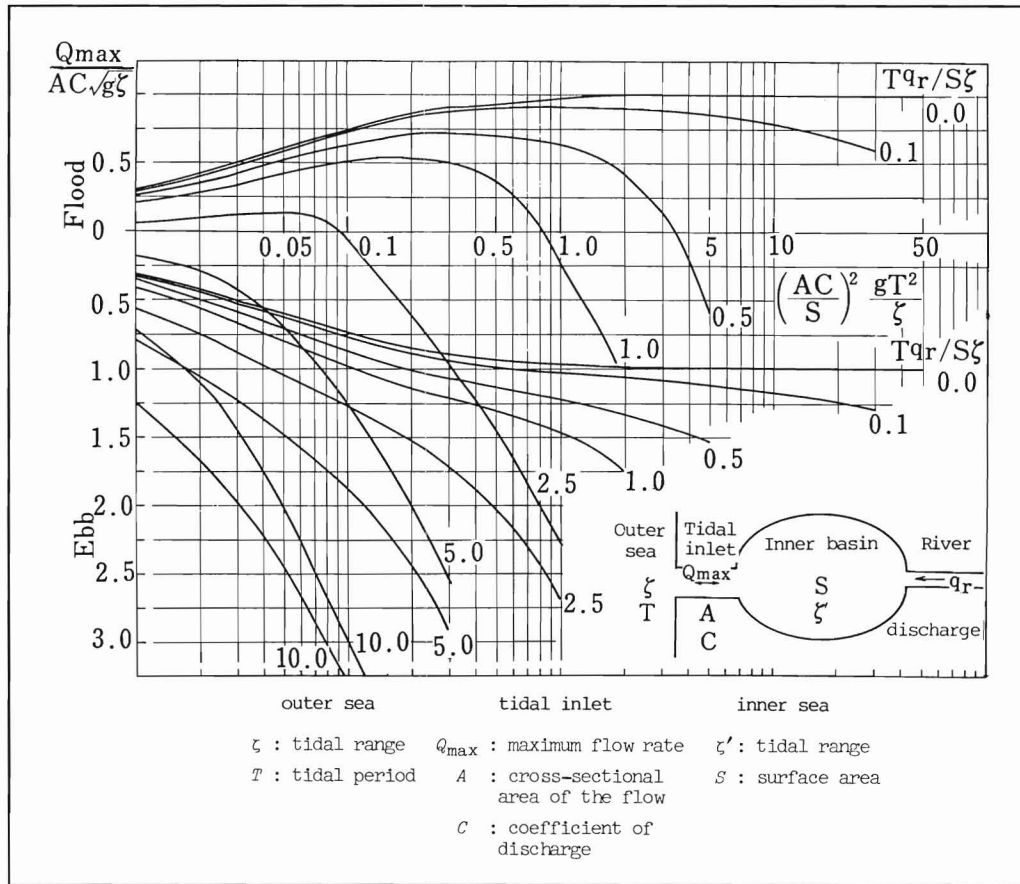

Figure 1
Maximum interchange flow rate.

Interchange by internal tide

In stratified liquid, there can be an internal wave. When an internal wave has a period comparable to a tidal period, it is called an internal tide. The propagating velocity of a long wave of an internal tide is so small that a resonance happens in a bay that has a length of less than 10 km. Propagating velocity of an internal tide, C , and surface tide, C_s , are expressed by

$$C = \sqrt{\varepsilon g \frac{h_1 h_2}{h_1 + h_2}} \quad (3)$$

$$C_s = \sqrt{g(h_1 + h_2)} \quad (4)$$

$$\varepsilon = \frac{\rho_2 - \rho_1}{\rho_2} \quad (5)$$

where h = layer thickness, ρ = water density, and suffix 1 and 2 represent the quantities of upper and lower layer, respectively.

A nondimensional density difference, ε , has an order of less than 0.01, so

$$C_s \gg C \quad (6)$$

that causes the resonance in bays with short lengths (Nakamura and Hagino 1980). The resonance results in increased wave amplitude, so there can be a large amplitude of internal tide. A large amplitude

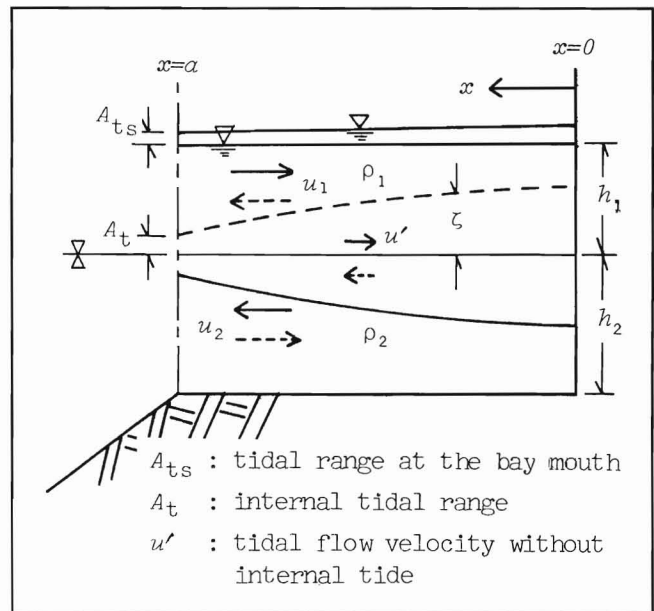

Figure 2
Symbols and synoptic presentation of flows due to internal tide.

of tide induces a large flow velocity in the bay. Flow rates of upper and lower layers q_1 and q_2 are calculated by,

$$q_1 = 4a \sin \sigma t \left[\frac{A_1}{(2n-1)T_1} \cdot \frac{\sin \frac{(2n-1)\pi T_1 x}{2aT}}{\cos \frac{(2n-1)\pi T_1}{2T}} \right. \quad (7)$$

$$\left. - \frac{A_2}{(2m-1)T_2} \frac{\sin \frac{(2m-1)\pi T_2 x}{2aT}}{\cos \frac{(2m-1)\pi T_2}{2T}} \right]$$

$$q_2 = \frac{4aA_2 \sin \sigma t}{(2m-1)T_2} \frac{\sin \frac{(2m-1)\pi T_2 x}{2aT}}{\cos \frac{(2m-1)\pi T_2}{2T}} \quad (8)$$

and the velocities by,

$$u_1 = \frac{q_1}{h_1 + \xi_1 - \xi_2} \quad (9)$$

$$u_2 = \frac{q_2}{h_2 + \xi_2} \quad (10)$$

and

$$\sigma = \frac{2\pi}{T}$$

$$T_1 = \frac{4a}{(2n-1)\sqrt{g(h_1+h_2)}} \quad (11)$$

$$T_2 = \frac{4a}{c_2(2m-1)} \quad (12)$$

where a = length of the bay, T = period of internal tide, A_2, A_1 = amplitudes of internal tide and surface tide at the bay mouth, t = time, and m, n = modes of internal and surface tide. T_1 means a proper oscillation period of the bay by surface tidal wave, and T_2 , by internal tide. For example, in Nomi Bay at Kochi, 20 m deep, 4 km long, the calculated u' by surface tidal range in Figure 2 was about 1 cm/s, but observed upper and lower layer velocities were about 20 cm/s, and they are compatible with the equations. This is a phenomenon accompanied by the internal tide. For application, i.e., locating and setting of the maricultural facilities, this phenomenon should be considered.

Tidal current control by training wall

The training wall, being located in reciprocal tidal currents where the flow energy is sufficient, can control flows (Nakamura et al. 1976). On an inlet where the training walls are located, the coefficient of discharge, C , is changed by flow conditions; the difference of C induces the tidal residual reciprocal flow. Coefficient of discharge, C_n , of the defined normal flow, downward in Figure 3, is larger than C_i , upward.

Flow rate is generally expressed by equation (1), the flow rate in normal flow, q_n , becomes larger than the inverse one, q_i . That causes the flow path at flood tide in Figure 4 to be larger than that at ebb tide.

Utilization of wave energy for mariculture

In deep water, the motion of seawater is circular due to wave action. In a shallow sea, its orbital motion is deformed due to the friction of the sea floor. As the wave nears shore, its height becomes larger and a water particle is transported in the propagating direction (shoaling). Shoaling can be used to raise the mean water level and to induce the water flow (Nakamura and Noma 1977).

Concentrated by the configuration of the intake channel, a wave travels to the upper end of the slope and over the level beyond. The flow rate is related to the configuration of the inlet and the incident wave. Noma (1982) reported the design detail and the deployed example at Taneichi.

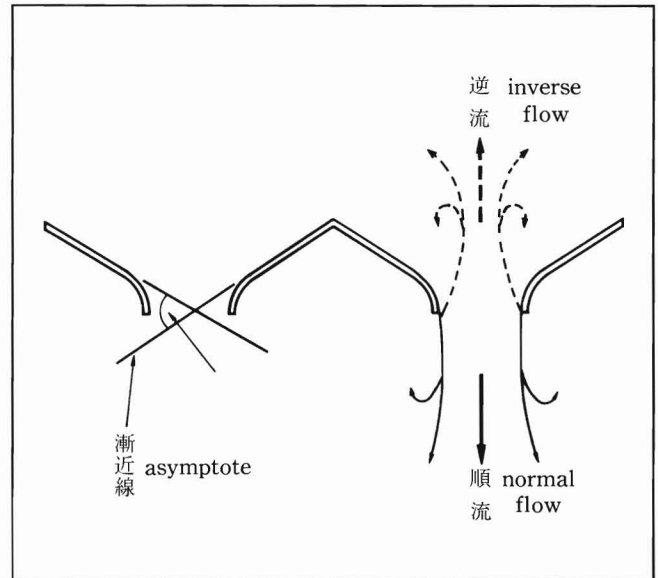

Figure 3
Configuration of training wall.

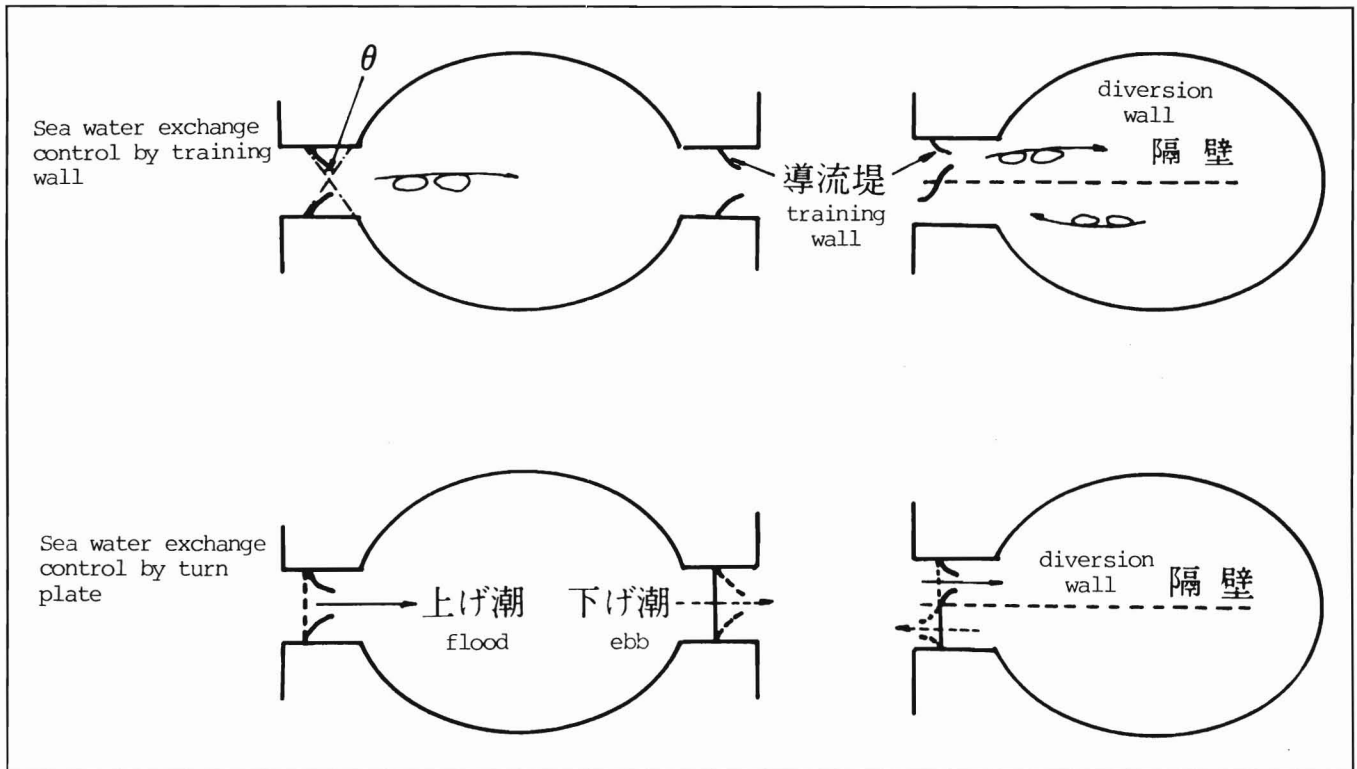

Figure 4
Tidal current control by training wall.

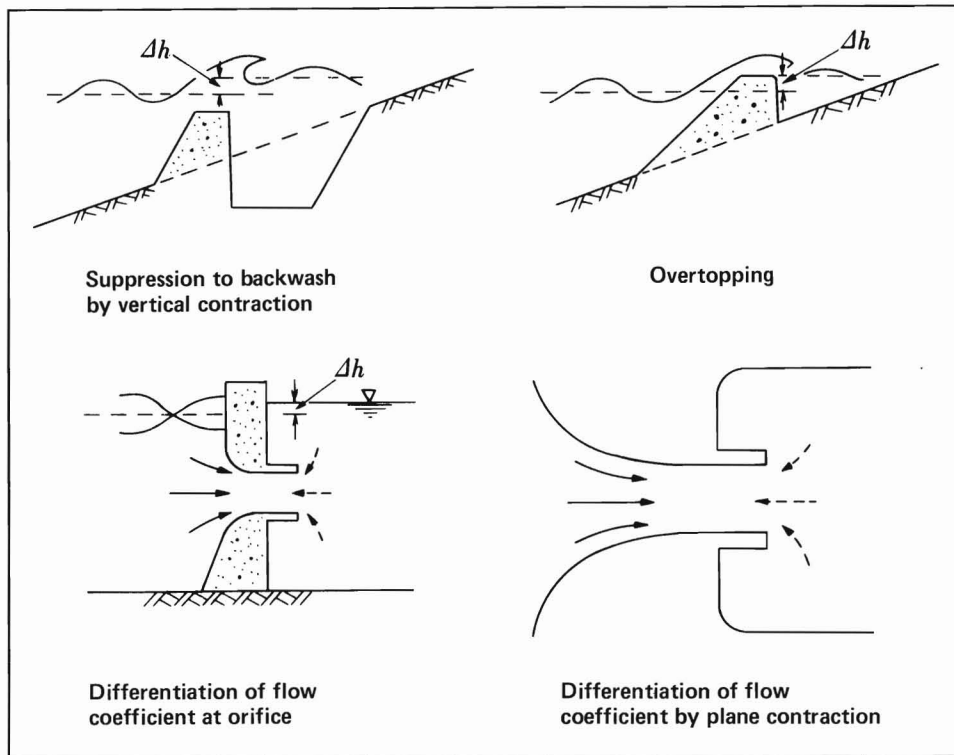

Figure 5

Mean water level raised by wave energy.

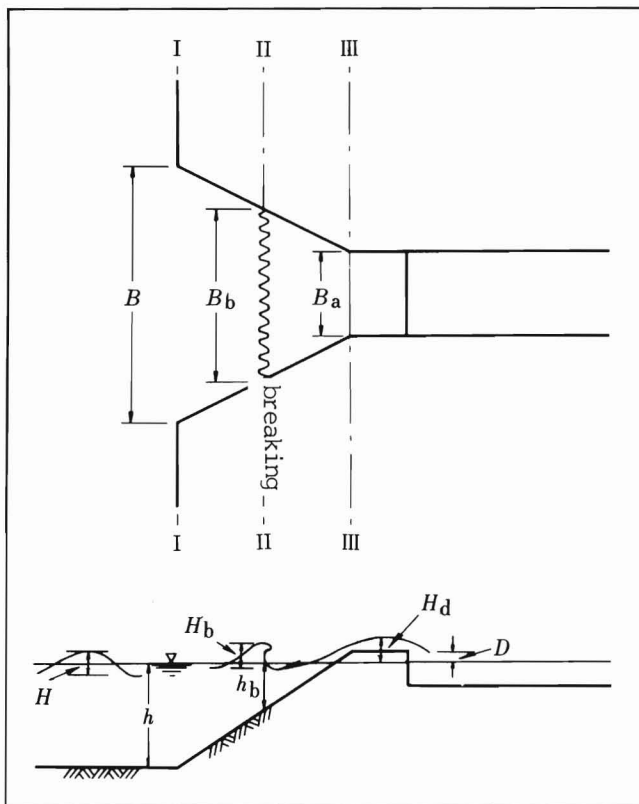

Figure 6

Wave energy concentration and breaking of wave.

Destratification by air bubble curtain (ABC)

It is desirable that maricultural waters have no thermal or density stratification for the sake of water quality conservation. To improve the water quality by destratification, ABC is one of the methods used with mechanical power. The flow pattern by ABC is as follows. The lifted water from the lower layer with greater density entrains the upper layer water, falls down to an appropriate density layer, and forms a third layer that flows away from ABC. Another upper and lower layer move toward the ABC. When the third layer collides with the end wall in a basin, it is divided into two ways, upper and lower, and they form another upper and lower layer. Thus the upper layer decreases in thickness and the lower increases (Noma 1980).

Destratification by ABC may be defined as a change of the thickness of the upper or lower layers, and a change of density of the lower layer. Its terminal phase is that the lower layer reaches to the surface and the density difference diminishes.

The change of lower layer thickness is expressed by

$$h_2 = h_{II} \exp(K_E t) \quad (k_{II} \leq h_2 \leq h_a) \quad (13)$$

$$K_E = \beta \frac{Q_a}{\epsilon_o h_{II} L} \quad \epsilon_o = \frac{\rho_{II} - \rho_I}{\rho_{II}}$$

where Q_a = flow rate of supplying air, t = time, and β = coefficient of experiment ($\beta = 0.125$).

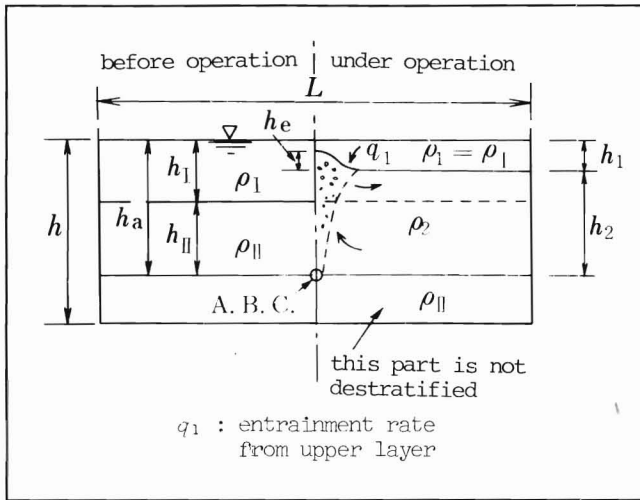

Figure 7
Synoptic presentation of the destratification by ABC.

Dispersion control

Marine organisms spend their early larval stage floating, and the larvae are wholly transferred by the motion of seawater. This may result in a wider distribution of the species, and on the other hand, may result in a critically high mortality rate at that stage. Dispersion control aims to limit the motion of seawater, including the larvae of target species, to stay in the planned area. At the same time, seawater should not be stagnant, it is expected to circulate, but to remain in an area. Circulation can be independent of a general flow and can prevent dispersion.

Wave-induced circulation

In a sea with waves, the alignment of a submerged dike induces circulation. The mechanism is as follows. On the submerged dike, a water particle is transported in the propagating direction by shoaling, it flows back through the portion where there is no submerged dike, i.e., deeper waters, and that makes a circulation. Intensity of the circulation depends on incident wave height, transmitted wave height, wave period, water depth, water depth on the dike, and coefficient of frictional resistance (Toda and Nakamura 1981). The flow velocity along the stream line around the submerged dike is principally calculated by

$$u = \frac{1}{n} h^{2/3} \left(\frac{\Delta h}{l} \right)^{1/2} \quad (14)$$

$$\Delta h = \frac{1}{w_o h_d} (S_I - S_T) \quad (15)$$

where Δh = water level difference by wave set-up, h = water depth, l = length of the stream line, h_d = water depth on the dike, n = Manning's coefficient of roughness, S_I , S_T = radiated stresses by waves in front of and behind the dike, and w_o = unit weight of seawater.

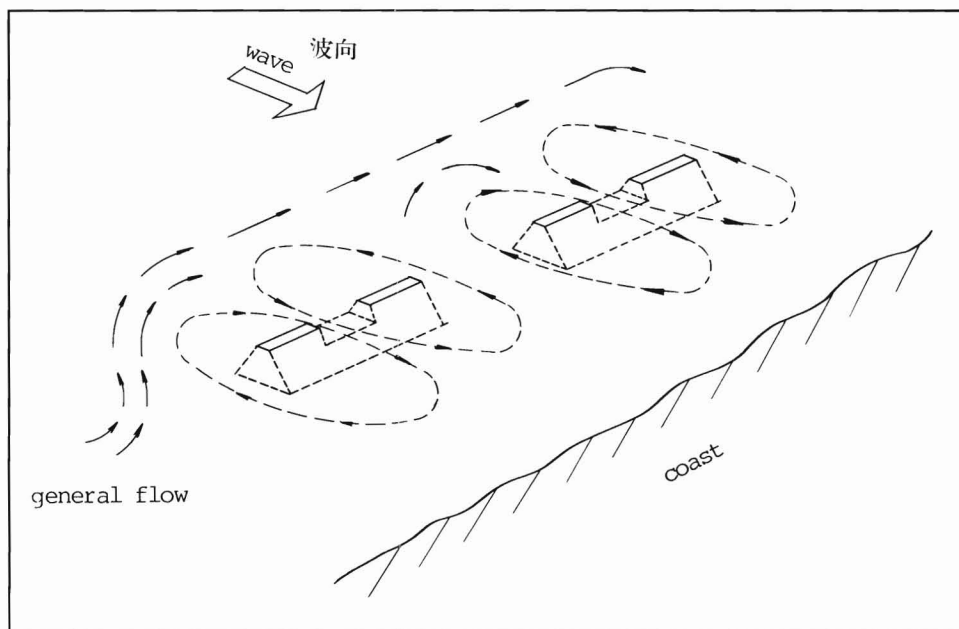

Figure 8
Synoptic presentation of wave-induced circulation.

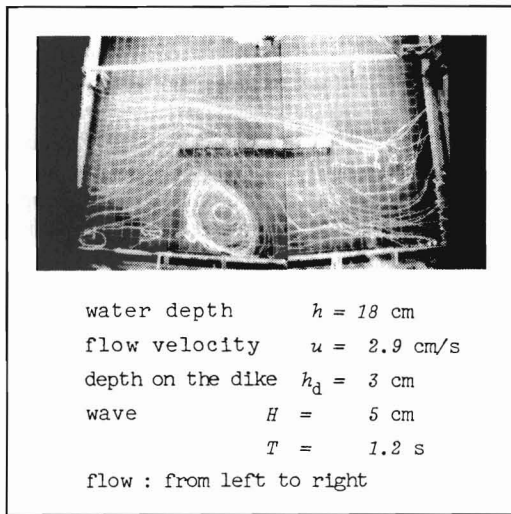

Figure 9

Wave-induced circulation under uniform flow in test basin.

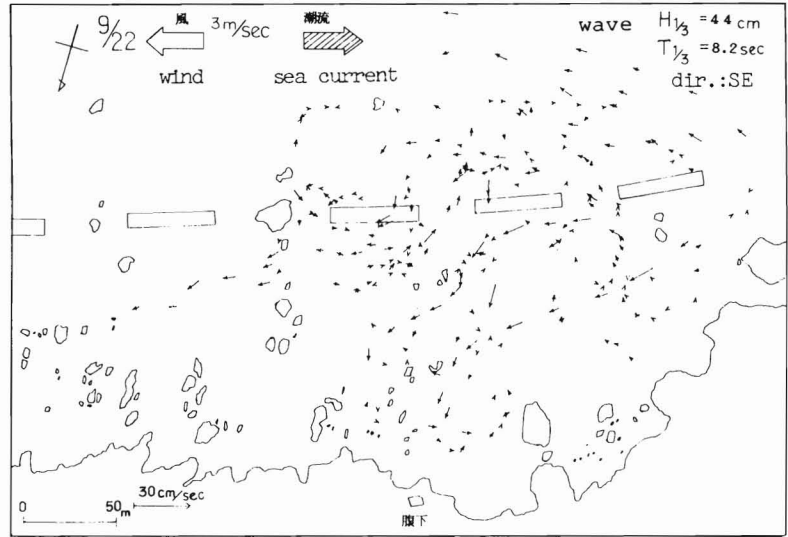

Figure 10

Field investigation of wave-induced circulation by drifting buoys.

Dye concentration in a wake

Behind a submerged structure under uniform flow, there exists a wake. Dimensional analysis of the wake has been performed. The size of the wake has been determined; the height is $1.6 \times$ barrier height, and the length is $10-15 \times$ barrier height. In a wake, there is a circulation that can detain dissolved substances. Changes in concentration of such substances can represent larvae, and they correspond well with the velocity field. The area behind the barrier is classified into three regions (Toda 1982, 1983):

Region I: region of potential flow, where the mean velocity is strong and turbulence is small; the dye transport, for example, is mainly done by advection.

Region II: intermediate region between I and III, where the vortex generated at the edge of the barrier passes.

Region III: region of the wake, where the mean velocity is weak and turbulence is large; the dye transport is mainly done by diffusion.

The dye concentration change in the wake is expressed by

$$\frac{C}{C_0} = e^{-\alpha t} \quad (16)$$

where C = the dye concentration at $t=t$, C_0 = the initial dye concentration, α = diffusion coefficient. For example, water depth $h = 5 \text{ m}$, barrier height $h_b = 1 \text{ m}$, flow velocity $U = 0.3 \text{ m/s}$, α in this case is experimentally given 0.0056. The detention time that the dye concentration ratio C/C_0 becomes 10% is 411 seconds; on the other hand, if there is no barrier, the transit time of dye through 10 times the barrier height is 33 seconds.

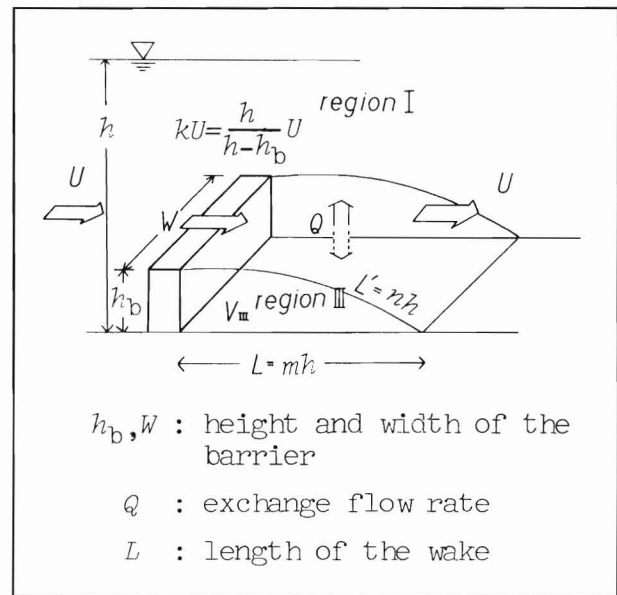

Figure 11

Definition sketch of the substance exchange behind wall.

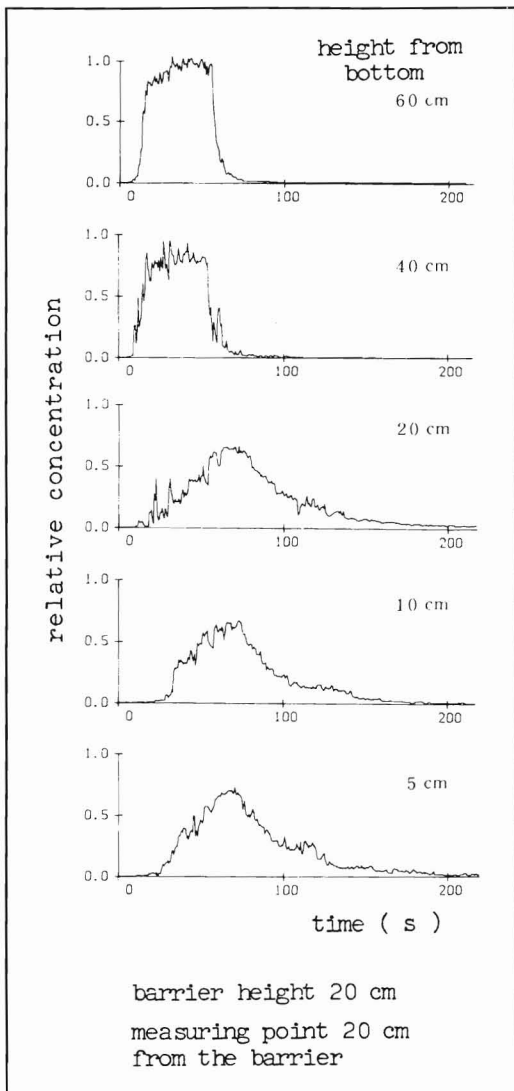

Figure 12

Change of dye concentration behind wall at different heights.

Conclusions

The above-mentioned methods are being adopted in coastal fishery grounds in Japan. Selection of the methods, from the viewpoint of the engineer, should be considered in terms of quantity and quality of energy. Energy sources in coastal water include tides, ocean currents, waves, internal waves, and wind. The quantity and quality of energy differ from site to site due to topography. The topographical condition and existing energy sources must be examined before adoption of any method.

Citations

Nakamura, M., and S. Hagino.

1977. Study on the sea water interchange. Bull. Nat. Res. Inst. Agric. Eng. 15:99-109.

1980. Study on sea water exchange by internal tide. Bull. Nat. Res. Inst. Fish. Eng. 1:1-7.

Nakamura, M., S. Hagino, and T. Noma.

1976. Study on the tidal current control for water quality improvement and application of its measure to Seto Inland Sea. Bull. Nat. Res. Inst. Agric. Eng. 14:201-221.

Nakamura, M., and T. Noma.

1977. Study of the induced inlet flow by the concentrated wave. Bull. Nat. Res. Inst. Agric. Eng. 15:87-98.

Noma, T.

1980. On air bubble curtain (A.B.C.) as a water quality improving method. Bull. Nat. Res. Inst. Fish. Eng. 1:9-32.

1982. Enhancement of seaweed and sea urchin by utilization of wave energy. Conference Record, 11th Meeting U.S.-Japan Marine Facilities Panel, p. 28-36.

Toda, S.

1982. On the characteristics of water exchange in the wake. Bull. Nat. Res. Inst. Fish. Eng. 3:13-24.

1983. On the characteristics of water exchange in the wake. (II) Non-dimensional expression of the coefficient of exchange. Bull. Nat. Res. Inst. Fish. Eng. 4:43-57.

Toda, S., and M. Nakamura.

1981. Experimental study on wave-induced circulation related to offshore structures. Bull. Nat. Res. Inst. Fish. Eng. 2:1-11.

Environmental conditions in pearl oyster culture grounds in Japan

KOUICHI OHWADA¹
HARUHIKO UEMOTO

National Research Institute of Aquaculture
Nakatsuhama, Nansei
Mie, 516-01 Japan

Production of cultured pearls in Japan dates back to the early 1900s. The amount of production has increased steadily since the start of culture, and remarkable development occurred during the 1950s, with Japanese pearls becoming world famous. Production dropped rapidly after 1967, however, due to a decrease in demand for pearls. Production of cultured pearls has been gradually rising again since 1975 with about 58 tons in 1983 (Fig. 1). Japanese fisheries statistics for 1983 report that pearl production is principally from the southwest coast of Japan, in Mie, Ehime, Kumamoto, and Nagasaki Prefectures (Fig. 2).

As a result of long-time use of the same areas as culture grounds, high density of culture, and eutrophication of coastal areas, pearl farms have been faced with environmental problems which sometimes lead to low productivity of culture areas, decrease in pearl quality, and mass mortality of cultured oysters. In this review, general environmental conditions in the pearl culture grounds and some environmental problems will be described. Details of culture techniques will not be described here, since they are available elsewhere (Cahn 1949, Kafuku and Ikenoue 1983, Mizumoto 1979).

Cultured organisms

Five species of bivalve molluscs, *Pinctada fucata*, *P. maxima*, *P. margaritifera*, *Pteria penguin*, and *Hyriopsis schlegeli*, are generally used in the pearl culture industry. *Pinctada fucata* is the species most commonly used for pearl culture in Japan. The culture techniques which produce spherical pearls have been developed primarily with this species. Most of the pearl production using *P. maxima* is in Australia. This species makes the larger round or

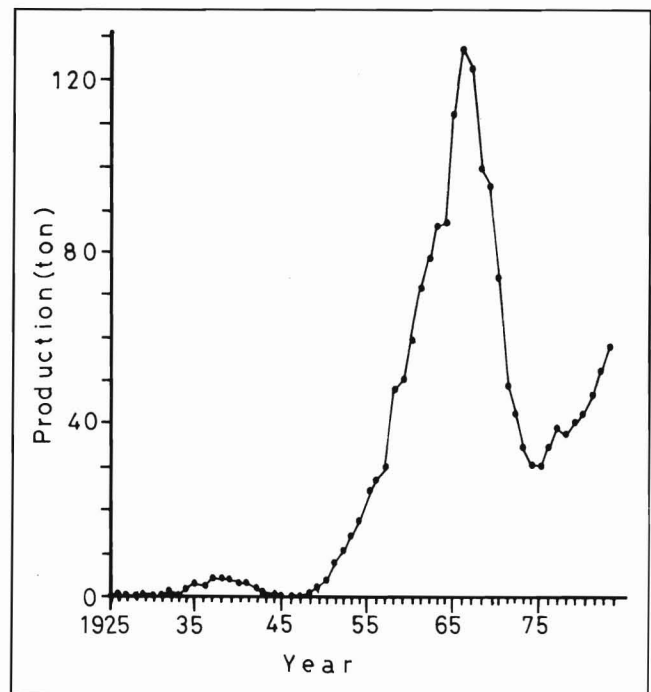

Figure 1

Annual production of cultured pearls (tons) in Japan (from Japanese Ministry of Agriculture, Forestry and Fisheries).

¹Present address: Ocean Research Institute, University of Tokyo, 15-1, 1 Chome, Minamidai, Nakano-ku, Tokyo, 164 Japan.

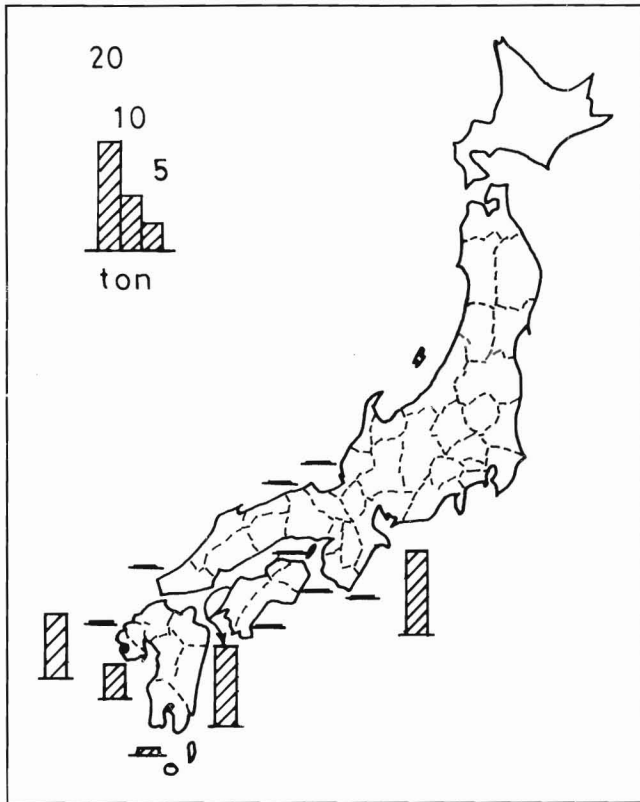

Figure 2

Distribution of cultured pearl production (tons) by Prefectures in 1983 (from Japanese Ministry of Agriculture, Forestry and Fisheries).

half pearls having a maximum diameter of 18 mm and a silver-white color. *P. margaritifera*, the "black pearl oyster," is most suitable for the production of steel black pearls and half pearls. *Pteria penguin*, known as "mabe" in Japan, is cultured to obtain large-sized half-round pearls. *Hyriopsis schlegeli* is a freshwater mussel, and pearl culture with this organism is done in Lake Biwa.

Culture and environmental conditions required for culture grounds

For pearl oyster culture, the hanging method with raft or long line is most commonly used. Standard size of a raft, which is composed of cypress or cedar logs, is about 6.4 × 5.5 meters, and four floats are attached underneath the raft. For the long-line method, a rope is attached to spherical plastic floats. This system, which is stronger than rafts in rough weather, is used at the entrance or outside a bay or inlet. Cages of synthetic netting with vinyl-coated wire frames are hung under the raft or the long line.

A year-round process of pearl culture with *Pinctada fucata* is shown in Figure 3. Natural spawning of pearl oysters begins at a temperature of around 20°C with maximum activity between 22 and 25°C. When collected shells grow to 5-10 mm in shell height, they are removed from the collector and are placed in baskets for hanging culture. Young pearl oysters are cultured in cages under rafts for about a year before being sold to pearl cultivators. During this cultivation period, cleaning of fouling organisms and extermination of the parasite, *Polydora ciliata*, are necessary to keep the oysters in good condition. In spring of the third year of life, the operation of nuclear insertion into the cultured mother shells

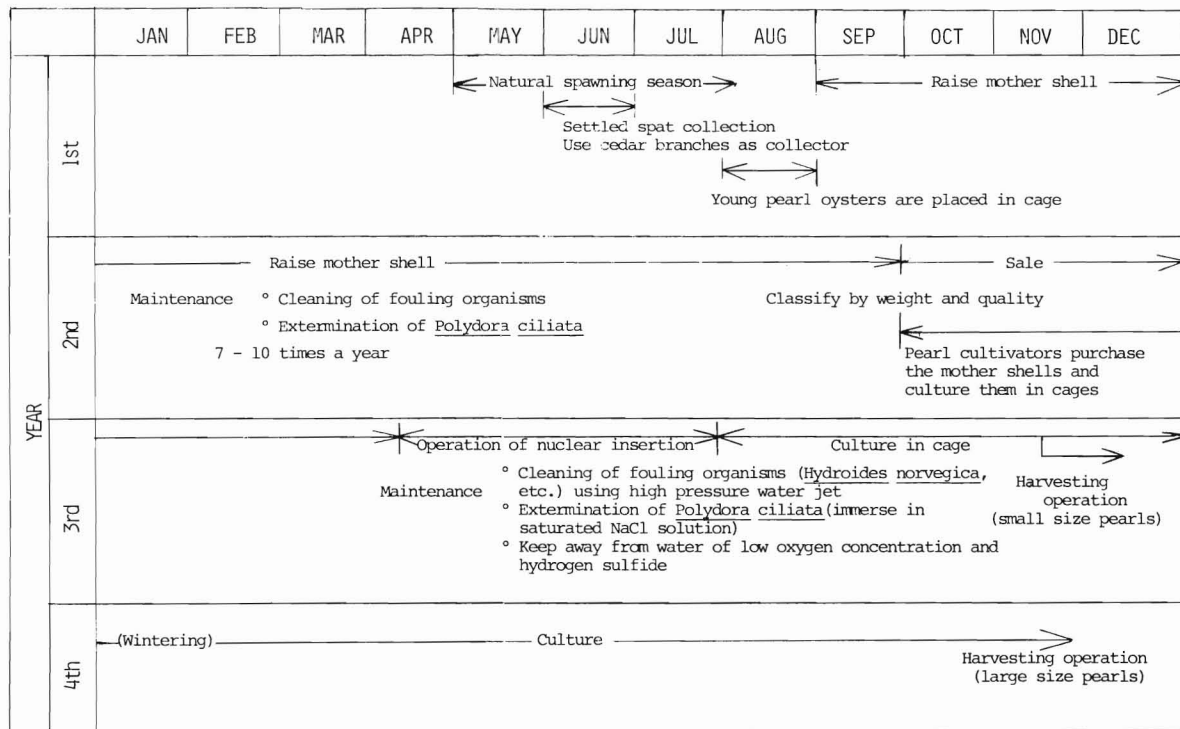

Figure 3

A year-round process of pearl culture with *Pinctada fucata*.

begins. Operations are conducted in spring and summer when the water temperature is above 15°C. During the operation, a nucleus and a piece of mantle are inserted into a part of the gonad of the mother shell. Operated shells are put into cages and cultured again in the water, under rafts or long lines. It takes 6-8 months for the small-sized pearls to be produced by the mother shells. For the larger sized pearl (6-9 mm in diameter), culture of an additional year is necessary.

Pinctada fucata is a temperate-zone species. Natural habitat is coarse sand, gravel, or rock bottom of inner bays, at a depth of less than 10 meters. Environmental conditions which permit survival of a pearl oyster are of primary importance in the culture grounds. These conditions are summarized from Kobayashi and Watabe (1959), Seki (1972), and Uemoto (1981a) as follows:

Temperature Basal metabolism of this species increases linearly with increase in temperature from 13 to 27°C. Above 27°C, it shows a sudden increase in metabolism. Below 13°C the metabolic rate drops remarkably and hibernation begins. In winter, it is a common practice among growers in the areas where water temperature decreases below 12°C to place oysters in warmer water to keep their physiological condition normal. Sudden changes in temperature (3-4°C of change during several hours) lead to exhaustion of energy.

Salinity Salinity of above 18‰ is required for normal growth. For the production of pearls of good quality, 21‰ or higher is necessary.

Oxygen Low oxygen concentration itself is not critical to the pearl oysters. They can tolerate relatively long periods at low oxygen concentrations, unless the level becomes extremely low (0-1.0 mg/L).

Current Metabolic rate increases proportionately with increase of water current up to about 15 cm/sec at a given temperature. Water current is important for the constant supply of food and oxygen, but a current in excess of 20 cm/sec results in an upset in metabolic rhythm.

Food The amount of suspended matter required for growth and reproduction of a pearl oyster is estimated to be about 100 grams dry weight per year. Suspended matter composed mainly of diatoms, such as *Chaetoceros*, *Thalassionema*, *Bacteriastrium*, *Skeletonema*, and *Melosira*, is preferable for good growth.

Some environmental problems in the culture grounds

Effect of high-density and repeated culture

Most of the pearl culture grounds in Japan are in relatively enclosed parts of bays, with a neritic environment. Water circulation in such areas is not strong enough to remove deposited substances from the culture area. High-density pearl oyster culture for long periods has resulted in accumulation of organic substances in the bottom muds which mainly consists of dead phytoplankton and faeces. Ito and Imai (1955) reported the decline in productivity of oyster beds by repeated culture, due to accumulation of organic matter in the sediments and toxic effects of hydrogen sulfide released from the sediments into the water. Deteriorated conditions of oyster beds

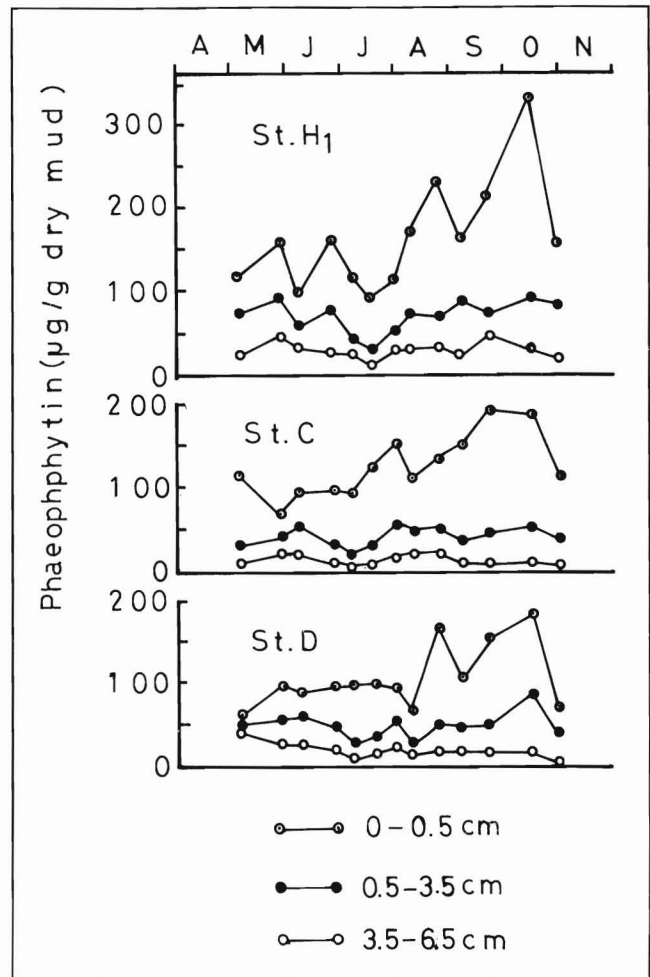

Figure 4

Seasonal changes of phaeophytin contents of muds ($\mu\text{g/g}$ dry mud) at the three stations in the innermost parts of Ago Bay in 1968 (Uyeno et al. 1970a).

and efforts for their improvement have been studied and summarized by Kusuki (1981).

From 1965 to 1967, when cultured pearl production was highest in Japan, 48,000 raft units were registered for use in pearl culture in Ago Bay, the most active culture ground in Japan (Seki 1981). Assuming that about 5,000 oysters were hung and cultured under a raft unit, then 240 million pearl oysters were estimated to be cultured in the bay. Average water space occupied by a raft unit was less than 200 m² in the innermost part of the bay. In the summer stagnation season, accumulated organic matter and reduced mixing of water led to high consumption of oxygen from the bottom water and at times even to hydrogen sulfide poisoning. Mass mortalities of cultured pearl oysters occurred at that time (Sawada et al. 1958).

Phaeophytin content of the mud, a degradation product of chlorophyll, is a good indicator of accumulated substances in pearl oyster grounds (Sawada and Uyeno 1966, Sawada and Taniguchi 1968a, Uyeno et al. 1970a) (Fig. 4). Sawada and Taniguchi (1969) and Takimoto (1984) have quantified the degree of deterioration of sediments using correlations between phaeophytin and organic carbon content, and between phaeophytin and organic nitrogen, respectively. Sawada and Taniguchi (1969) suggested a reduction of raft numbers in Ago Bay to a level at which one raft unit would

occupy at least 848 m² of cultured area, so that normal nutrient circulation could be continued in the bay.

Through detailed observations of culture area, Uyeno et al. (1970b) proposed an equation for estimating the bottom fouling as follows,

$$\int_{t_1}^{t_2} A - \int_{t_1}^{t_2} B = \int_{t_1}^{t_2} C + F_{t_2} - F_{t_1} \quad (1)$$

where $\int_{t_1}^{t_2} A$ = organic substances accumulated on the surface of bottom mud from the time t_1 to t_2

$\int_{t_1}^{t_2} B$ = amount of effluent organic substances from the mud surface during t_1 to t_2

$\int_{t_1}^{t_2} C$ = amount of decomposed organic substances in the superficial bottom mud during t_1 to t_2

F_{t_1} = amount of organic substances at t_1

F_{t_2} = amount of organic substances at t_2 .

$\int_{t_1}^{t_2} C$ can be expressed as follows,

$$\int_{t_1}^{t_2} C = (O_s - O_{ob})_{t_2} \cdot f \quad (2)$$

where O_s = theoretical solubility of oxygen

O_{ob} = observed oxygen concentration

f = a factor characteristic of the area associated with the decomposed organic substances between t_1 and t_2 represented by phaeophytin.

Then the following equation can be obtained,

$$\int_{t_1}^{t_2} A - \int_{t_1}^{t_2} B = (O_s - O_{ob})_{t_2} \cdot f + F_{t_1} - F_{t_2} \quad (3)$$

Thus if the data on water temperature, salinity, dissolved oxygen, and phaeophytin in the superficial bottom mud are available, then the extent of bottom fouling can be ascertained rather easily. It would then become possible to calculate the optimum number of cultured pearl oysters per unit area from the viewpoint of water quality and bottom fouling.

Uemoto (1981b) estimated the amount of deposited matter and fouling organisms per unit of raft in a year in Ago Bay as shown in Table 1. Amount of total deposited matter from cultured pearl oysters and fouling organisms was estimated to be 221.7 kg in a year if 100 cages (each cage holding 50 oysters) have been cultured. The total amount of fouling organisms, which had been removed by the cleaning process, was estimated to be 394.4 kg in a year. Estimation of this amount as chemical and biological oxygen demand, organic nitrogen, and organic carbon is shown in Table 2. Similar results have also been reported in Uwajima Bay, Ehime Prefecture (Takimoto 1984). Uemoto (1981b) further estimated the total amount of discharge by pearl oyster culture into Ago Bay in 1975, assuming that 30,000 units of rafts were used, as 530 tons as chemical oxygen demand, 160 tons as biological demand, 54 tons as organic nitrogen, and 440 tons as organic carbon.

Table 1

Estimation of deposited matter and fouling organisms per one raft unit, holding 100 cages, in a year. Culture period is counted as 245 days from May to December. Cultured oysters are transferred to another place for hibernation in remaining days of a year (Uemoto 1981b).

1) Average dry weight of deposited matter from culturing pearl oysters:	4.6 g × 100 cages × 245 days = 112.7 kg
2) Average dry weight of deposited matter from fouling organisms on cages:	3.6 g × 100 cages × 245 days = 88.2 kg
3) Average dry weight of deposited matter from fouling organisms on floats:	21.2 g × 4 floats × 245 days = 20.8 kg
4) Average dry weight of fouling organisms on cages (cleaning is conducted once a month):	493 g × 100 cages × 8 months = 394.4 kg
Deposited matter	221.7 kg
Fouling organisms	394.4 kg
Total	616.1 kg

Table 2

Amount of deposited matter from one raft unit in a year expressed as chemical (COD) and biological (BOD) oxygen demand, organic nitrogen, and organic carbon.

	COD	BOD	O-N	O-C
	----- (kg) -----			
Deposited matter from oysters	11.6	3.9	1.2	9.3
Deposited matter from fouling organisms on cages	5.1	1.0	0.6	4.6
Deposited matter from fouling organisms on floats	1.1	0.4	0.1	0.9
Total	17.8	5.3	1.9	14.8

Eutrophication of coastal waters

Seki (1981) and Uemoto (1981a) reviewed the present status of eutrophication of pearl oyster grounds in various localities. They showed that long-term effects of eutrophication of coastal waters would gradually appear in the bottom quality, and as changes in the flora and fauna in the water and sediment, rather than in the apparent nutrient levels in the water. For example, Uemoto (1981a) could not find clear changes in nutrient levels in the water of Ago and Uwajima Bays from 1959 to 1977. Yamamura (1972), however, observed a succession of marine fouling communities in Ago Bay between 1958 and 1967 (Table 3). Increasing concentrations of total sulfide and organic carbon in the sediments of the innermost part of Ago Bay have been observed (Seki 1981) (Fig. 5). Occurrences of red tides caused by dinoflagellates have been increasing in Gokasho and Ago Bay areas (Seki 1981) (Fig. 6). Honjo et al. (1984) observed the virtual disappearance from the water of diatom communities, which are good food for the cultured pearl oyster, for about a month during June 1984, while Gokasho Bay was attacked by red tide caused by *Gymnodinium nagasakiense*.

According to the Environmental Division, Mie Prefecture, total sewage wastes around the Ago Bay area amounted to about 2 tons of biological oxygen demand and 0.78 tons of nitrogen per day in 1973, namely 730 tons of biological oxygen demand and 285

Table 3
Comparison of dominant species of fouling organisms in Ago Bay in summer (July-August) between 1958 and 1967, modified from Yamamura (1972).

1958*			1967		
Species**	†No. per 1,600 m ²	%	Species**	†No. per 1,600 m ²	%
<i>Dexiospira foraminosus</i>	14,214	84.2	<i>Hydroides norvegica</i>	4,149	53.2
<i>Balanus variegatus tessellatus</i>	1,769	10.5	<i>Balanus variegatus tessellatus</i>	2,169	28.1
<i>Dakaria subovoidea</i>	694	4.1	<i>Musculus senhousia</i>	354	4.5
			<i>Dexiospira foraminosus</i>	313	4.0
			<i>Balanus improvisus</i>	146	1.9
Total	16,889		Total	7,803	

*Data cited from Kawahara and Iijima (1960).

**Only dominant species are presented.

†Total number of individuals attached to the surface of the concrete blocks immersed at four different depths (0, 2, 3.5, and 5 m).

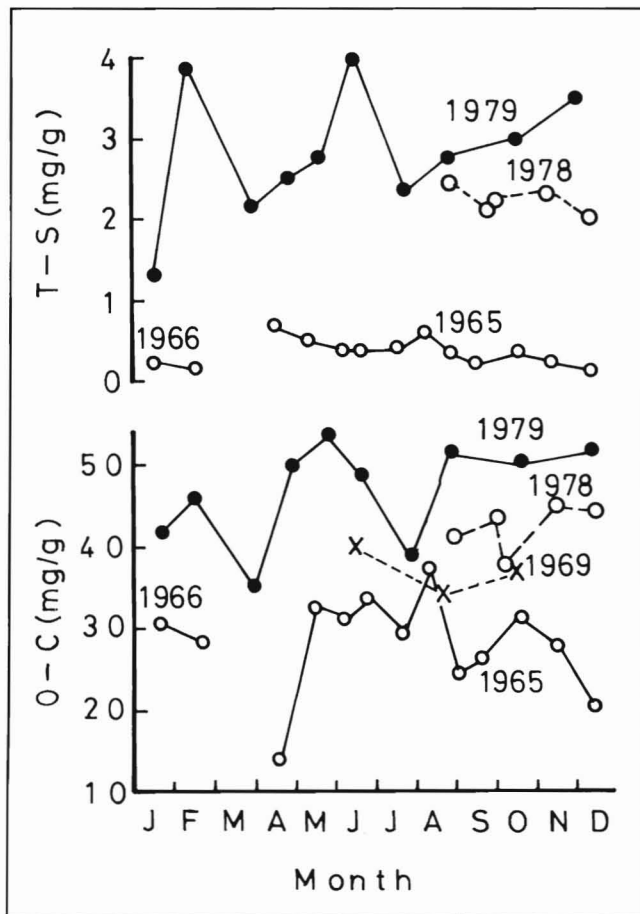

Figure 5

Seasonal changes of total sulfide (T-S) and organic carbon (O-C) contents in the sediment at the innermost part of Ago Bay for different years (Seki 1981).

tons of nitrogen per year (Uemoto 1981b). Even though all the amount has not been discharged into the bay, the total was significantly higher than the discharge from pearl oyster culture in the bay.

The coastal enclosed bay areas which used to be mostly utilized for pearl oyster culture are now used for various other aquacul-

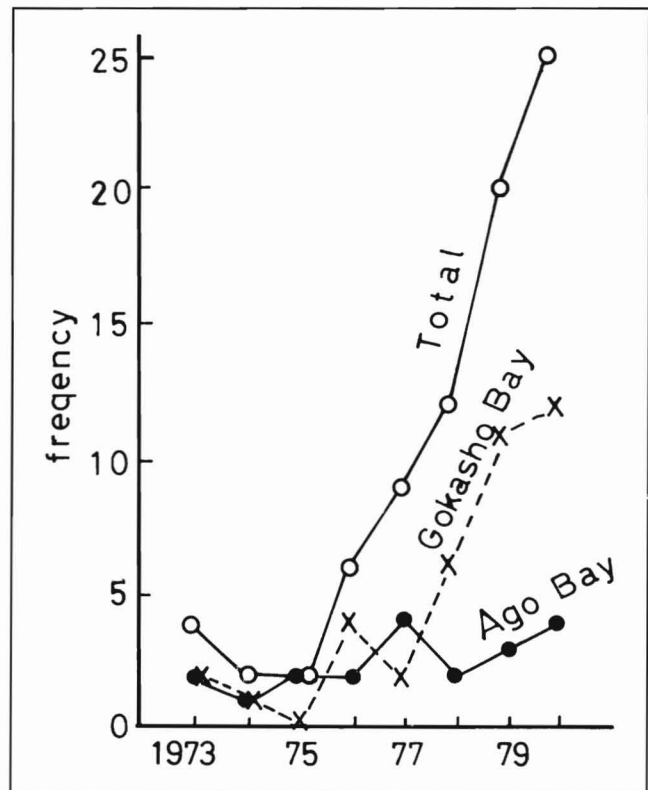

Figure 6

Occurrence of red tide in Gokasho and Ago Bay areas (Seki 1981).

tural activities. Among these, utilization for finfish culture has been most prominent. Discharge of organic material into the surrounding environment from yellowtail culture has been studied by Sakamoto (1976). He estimated higher organic loading of the surrounding waters by yellowtail culture than by waste discharge from the land area. Finfish cultural activities as well as sewage waste would also contribute to eutrophication of coastal pearl oyster culture grounds where finfish and pearl oyster culture are located close together.

Approach to improve deteriorated bottom quality

Improvement of deteriorated environmental conditions caused by red tides has been studied by the Fisheries Agency (Fisheries Agency 1983). Several attempts have also been made to improve deteriorated bottom conditions in the enclosed areas of pearl oyster grounds, such as cultivation (Sawada and Taniguchi 1967, Uyeno 1964) and explosive ploughing of the sediment (Sawada et al. 1968), underwater blasting of obstacles (Sawada and Taniguchi 1968b), bottom aeration (Mie Prefect. Fish. Exp. Stn. 1966), and sprinkling ferric oxide on the bottom sediment (Seki and Shibahara 1967). A recent approach of liming the bottom sediment seems to be successful for preventing hydrogen sulfide formation in the deteriorated bottom areas (Nishimura and Seki 1983). The amount of lime required is estimated to be 100-200 grams/m².

Citations

- Cahn, A.R.**
1949. Pearl culture in Japan. Nat. Resour. Sect. 122, GHQ, 91 p.
- Fisheries Agency.**
1983. Manual of the projects on developing techniques for protection from damage by red tides in mariculture grounds, 51 p. (in Jpn.).
- Honjo, T., K. Ohwada, N. Tanaka, S. Toda, A. Asakawa, and H. Uemoto.**
1984. On the red tide causing major damage to cultured fishes and shellfishes in Gokasho Bay. Natl. Res. Inst. Aquacult. news 8:5-9 (in Jpn.).
- Ito, S., and T. Imai.**
1955. Ecology of oyster bed. I. On the decline of productivity due to repeated cultures. Tohoku J. Agric. Res. 5:251-268.
- Kafuku, T., and H. Ikenoue (eds.).**
1983. Modern methods of aquaculture in Japan. Developments in aquaculture and fisheries science, vol. 11. Elsevier Sci. Publ. Co., 216 p.
- Kawamura, T., and H. Iijima.**
1960. On the constitution of marine fouling communities at various depths in Ago Bay. Rep. Fac. Fish. Mie Univ. 3:582-594.
- Kobayashi, S., and T. Watabe.**
1959. Studies on Pearls. Gihodo Publisher, 280 p. (in Jpn.).
- Kusuki, Y.**
1981. Fundamental studies on the deterioration of oyster growing grounds. Bull. Hiroshima Fish. Exp. Stn. 11:1-93 (in Jpn.).
- Mie Prefectural Fisheries Experimental Station.**
1966. Effect of aeration of bottom sediment on the improvement of pearl culture grounds. Annu. Proj. Rep., Mie Prefect. Fish. Exp. Stn. for 1964, p. 144-148 (in Jpn.).
- Mizumoto, S.**
1979. Pearl farming in Japan. In Pillay, T. V. R., and W. A. Dill, (eds.) Advances in Aquaculture, p. 381-385. Fishing News Books, Ltd.
- Nishimura, A., and M. Seki.**
1983. Effects of lime on the improvement of mariculture grounds. Bull. Jpn. Soc. Sci. Fish. 49:353-358 (in Jpn.).
- Sakamoto, I.**
1976. Assessment of the load caused by pisciculture to the environment. Rep. Environ. Sci. Mie Univ. 1:181-203 (in Jpn.).
- Sawada, Y., M. Tange, and M. Seki.**
1958. The oceanographical studies on the pearl culture ground. I. On the oceanographical observation of unusual death of pearl oyster at Tategami-ura in Ago Bay in July 1958. Bull. Natl. Pearl Res. Lab. 4:347-355 (in Jpn.).
- Sawada, Y., and M. Taniguchi.**
1967. The oceanographical studies on the pearl culture ground. IV. On the seasonal changes of bottom conditions and the improvement method of bottom mud in the superannuated pearl farm. Bull. Natl. Pearl Res. Lab. 12:1379-1408 (in Jpn.).
- 1968a. The oceanographical studies on the pearl culture ground. V. On the seasonal changes of organic matter and phaeophytin contents in bottom mud of the superannuated pearl culture ground. Bull. Natl. Pearl Res. Lab. 13:1689-1702 (in Jpn.).
- 1968b. Studies on the underwater blasting of reef in the pearl culture ground (II). IV. On the changes of environment of the pearl culture ground by the underwater blasting. Bull. Natl. Pearl Res. Lab. 13:1703-1711 (in Jpn.).
1969. The oceanographical studies on the pearl culture ground. VI. On the relation between the raft density in pearl culture ground and the contaminated degree of bottom mud. Bull. Natl. Pearl Res. Lab. 14:1719-1734 (in Jpn.).
- Sawada, Y., M. Taniguchi, Y. Wakazono, T. Ogawa, and M. Nakano.**
1968. Studies on the explosion ploughing of the bottom mud in the superannuated pearl culture ground. Bull. Natl. Pearl Res. Lab. 13:1241-1247 (in Jpn.).
- Sawada, Y., and F. Uyeno.**
1966. Studies on the acetone extracts from marine mud and faeces of pearl oyster (*Pinctada martensi*). I. On the absorption spectra of acetone extracts. Bull. Natl. Pearl Res. Lab. 11:1298-1307 (in Jpn.).
- Seki, M.**
1972. Studies on environmental factors for the growth of pearl oyster, *Pinctada fucata*, and the quality of its pearl under the culture condition. Bull. Mie Prefect. Fish. Exp. Stn. 1:32-149 (in Jpn.).
1981. Present status of eutrophication in pearl culture grounds and their improvement. Bull. Jpn. Soc. Sci. Fish. Oceanogr. 38:38-41 (in Jpn.).
- Seki, M., and N. Shibahara.**
1967. Effects of sprinkling ferric oxide on the bottom sediments for the improvement of pearl culture ground. Annu. Proj. Rep. Mie Prefect. Fish. Exp. Stn. for 1965, p. 221-228 (in Jpn.).
- Takimoto, S.**
1984. Studies on the organic loading into culture farm by pearl oyster culture. Aquiculture (Sendai) 32:77-82 (in Jpn.). See Suisan Zoshoku (Fish. Cult.).
- Uemoto, H.**
1981a. Long term changes of nutrient levels and succession of pearl oyster culture grounds. Bull. Jpn. Soc. Sci. Fish. Oceanogr. 38:28-37 (in Jpn.).
- 1981b. On the depositing matter in the pearl culture grounds. In The process of settling and sedimentation in bay and coastal region, p. 126-138. Jpn. Fish. Resour. Conserv. Assoc. (in Jpn.).
- Uyeno, F.**
1964. Relationships between production of foods and oceanographical condition of sea water in pearl farms. II. On the seasonal changes of sea water constituents and bottom condition, and the effect of bottom cultivation. J. Fac. Fish. Prefect. Univ. Mie 6:145-169 (in Jpn.).
- Uyeno, F., S. Funahashi, and A. Tsuda.**
1970a. Preliminary studies on the relation between faeces of pearl oyster (*Pinctada martensi*) and bottom conditions in an estuarine pearl oyster area. J. Fac. Fish. Prefect. Univ. Mie 8:113-137 (in Jpn.).
- Uyeno, F., K. Kawaguchi, N. Terada, and T. Okada.**
1970b. Decomposition, effluent and deposition of phytoplankton in an estuarine pearl oyster area. J. Fac. Fish. Prefect. Univ. Mie 7:7-41 (in Jpn.).
- Yamamura, Y.**
1972. Ecological studies of marine fouling communities in pearl culture ground. II. Seasonal changes in the constitution of marine fouling communities at various depths in Ago Bay. Bull. Natl. Pearl Res. Lab. 16:2038-2051 (in Jpn.).